

Flour - Bread '15 : Proceedings of the 8th International Congress Flour - Bread '15

Ajredini, Saša; Andrejaš, Martina; Avdić, Azem; Avdić, Gordan; Babić, Hrvoje; Barišić, Nada; Bartalné-Berceli, Monika; Bliznikas, Saulius; Bodroža-Solarov, Marija; Borges, Saulo; ...

Edited book / Urednička knjiga

Publication status / Verzija rada: **Published version / Objavljena verzija rada (izdavačev PDF)**

Publication year / Godina izdavanja: **2016**

Permanent link / Trajna poveznica: <https://urn.nsk.hr/urn:nbn:hr:109:047759>

Rights / Prava: [In copyright](#) / [Zaštićeno autorskim pravom.](#)

Download date / Datum preuzimanja: **2024-07-17**



image not found or type unknown

Repository / Repozitorij:

[Repository of the Faculty of Food Technology Osijek](#)



image not found or type unknown

**JOSIP JURAJ STROSSMAYER UNIVERSITY OF OSIJEK
FACULTY OF FOOD TECHNOLOGY OSIJEK, CROATIA**

**ICC – INTERNATIONAL ASSOCIATION FOR
CEREAL SCIENCE AND TECHNOLOGY**

**Proceedings of the
8th INTERNATIONAL CONGRESS
FLOUR – BREAD '15**

**10th CROATIAN CONGRESS
OF CEREAL TECHNOLOGISTS**

Opatija, October 29 - 30, 2015

PROCEEDINGS OF THE
8th INTERNATIONAL CONGRESS
FLOUR – BREAD '15
10th CROATIAN CONGRESS
OF CEREAL TECHNOLOGISTS

Published by:

JOSIP JURAJ STROSSMAYER UNIVERSITY OF OSIJEK
FACULTY OF FOOD TECHNOLOGY OSIJEK, CROATIA

Editor-in-Chief

Daliborka Koceva Komlenić

Executive Editor

Marko Jukić

Editorial Board

Mirela Planinić

Sanda Hasenay

Jasmina Lukinac Čačić

Address of Editorial Board

Faculty of Food Technology Osijek

Franje Kuhača 20, P.O. Box 709

HR-31 000 Osijek, CROATIA

Tel.: +385 31 224 300

Fax: +385 31 207 115

e-mail:

marko.jukic@ptfos.hr

daliborka.koceva@ptfos.hr

Printed by

Grafika d.o.o. Osijek

Edition

50 copies

ISSN 1848-2562

8th INTERNATIONAL CONGRESS
FLOUR – BREAD '15
 10th CROATIAN CONGRESS OF
 CEREAL TECHNOLOGISTS

OPATIJA, CROATIA
 October 29-30, 2015

ORGANIZERS

JOSIP JURAJ STROSSMAYER UNIVERSITY OF OSIJEK
 FACULTY OF FOOD TECHNOLOGY OSIJEK, CROATIA

ICC – INTERNATIONAL ASSOCIATION FOR
 CEREAL SCIENCE AND TECHNOLOGY

In partnership with CROATIAN FOOD AGENCY

UNDER THE AUSPICES OF:

Ministry of Science, Education and Sports of the Republic of Croatia
 Ministry of Agriculture of the Republic of Croatia
 Josip Juraj Strossmayer University of Osijek
 Croatian Parliament - Agriculture Committee
 Croatian Academy of Engineering

SCIENTIFIC COMMITTEE		ORGANIZING COMMITTEE	
Daliborka Koceva Komlenić <i>(President)</i>	Croatia	Daliborka Koceva Komlenić <i>(President)</i>	Croatia
Duška Ćurić	Croatia	Michaela Pichler <i>(Vice-President)</i>	Austria
Krešimir Dvojković	Croatia	Mirela Planinić <i>(Vice-President)</i>	Croatia
Daniela Čačić Kenjerić	Croatia	Jurislav Babić	Croatia
Andrea Gross-Bošković	Croatia	Mate Bilić	Croatia
Ivica Ikić	Croatia	Andrea Gross-Bošković	Croatia
Katarina Jukić	Croatia	Vlado Guberac	Croatia
Midhad Jašić	Bosnia & Herzegovina	Katarina Jukić	Croatia
Marko Jukić	Croatia	Marko Jukić	Croatia
Dragan Kovačević	Croatia	Indira Kosović	Croatia
Alojzije Lalić	Croatia	Dragan Kovačević	Croatia
Jasna Mastilović	Serbia	Zlatko Mijić	Croatia
Michaela Pichler	Austria	Ivana Rukavina	Croatia
Ivana Rukavina	Croatia	Drago Šubarić	Croatia
András Salgó	Hungary	Zvonimir Zdunić	Croatia
Drago Šubarić	Croatia		
Ljiljana Unbehend	Germany		
Günter Unbehend	Germany		

The information provided in this Proceedings are the sole responsibility of the authors of papers. Publisher is not responsible for any use that might be made of the data appearing in this document.

GOLD SPONSORS

MINISTRY OF SCIENCE, EDUCATION AND SPORTS OF THE REPUBLIC OF CROATIA

MINISTRY OF AGRICULTURE OF THE REPUBLIC OF CROATIA

SILVER SPONSORS

BRABENDER GmbH & Co. KG, Germany (Ru-Ve d.o.o., Croatia)

URŠIČ d.o.o., Slovenia

GRAND HOTEL ADRIATIC OPATIJA

BRONZE SPONSORS

INSPECTO d.o.o.

PEKARSTVO KADULJA d.o.o.

HYPO ALPE-ADRIA-BANK d.d.

TOURIST BIRO OF CITY OPATIJA

PREFACE

The 8th International Congress and the 10th Croatian Congress of Cereal Technologists "Flour-Bread '15" was held from 29-30 October 2015 in Opatija, Croatia. The Congress has been organized by the Faculty of Food Technology in Osijek and the International Association for Cereal Science and Technology (ICC). The Congress was organized under the auspices of the Ministry of Agriculture of the Republic of Croatia, the Ministry of Science, Education and Sports of the Republic of Croatia, the Josip Juraj Strossmayer University of Osijek, Croatian Parliament-Agriculture Committee and the Croatian Academy of Engineering.

The "Flour-Bread" Congress has been organized traditionally every second year since 1997 and become one of the most significant European scientific meetings in the field of cereal science and technology. The research results presented at "Flour-Bread" Congresses provides faster acceptance of the latest scientific and professional achievements in cereal production and processing, development of new products and quality enhancement.

The "Flour-Bread '15" Congress topics were the following: breeding and quality of cereal grains, grain storage and milling technology, analytical and rheological methods, baking technology, improvers and additives, starch and modified starch, extrusion and pasta production, biscuit and pastry products, nutritional quality of cereals, cereal food safety and cereal based functional foods.

Despite the economic recession worldwide, over 100 experts from 20 countries took part in the Congress (Austria, Argentina, Bosnia and Herzegovina, Brazil, Czech Republic, Iran, Italy, China, Latvia, Lithuania, Hungary, Kosovo, Malaysia, Mexico, Netherlands, Germany, Poland, Slovakia, Slovenia, Serbia, and of course Croatia). There were 29 oral presentations and 49 posters at the Congress. Eleven national and international companies presented their production programmes, process and laboratory equipment and cereal industry products.

Many new scientific achievements were introduced to the Congress participants and they also had opportunity to exchange their personal experiences with the experts from various institutions and industry.

Editors

CONTENTS

Scientific papers

IMAGE ANALYSIS TESTING OF BREAD WITH NON-TRADITIONAL PLANT RAW MATERIALS	1
<i>Ivan Švec, Marie Hrušková</i>	
RESISTANCE OF SOURDOUGH STARTER CULTURES TO FREEZING	11
<i>Saša Ajredini, Dubravka Novotni, Nikolina Čukelj, Marina Krpan, Mirjana Hruškar, Duška Ćurić</i>	
CHARACTERISTIC OF BARLEY SOURDOUGH DURING FROZEN STORAGE	21
<i>Ivna Vrana Špoljarić, Nikola Maričić, Dubravka Novotni, Saša Ajredini, Bojana Voučko, Duška Ćurić</i>	
POSSIBILITIES OF USING ACORN FLOUR IN PRODUCTS BASED ON FLOUR	33
<i>Mirjana Polimac, Daliborka Koceva Komlenić, Jasmina Lukinac</i>	
DIRECT POTENTIOMETRY STUDY OF AMYLOSE AND CETYLPIRIDINIUM CHLORIDE INTERACTION	49
<i>Maja Karnoš, Hrvoje Babić, Marko Ivić, Saulo Borges, Nikola Sakač</i>	
BROWNING DEVELOPMENT IN BAKERY PRODUCTS ENRICHED WITH FOOD INDUSTRY BY-PRODUCTS	55
<i>Jasmina Lukinac, Marko Jukić, Frane Čačić Kenjerić, Paola Kolak, Tamara Efendić, Daliborka Koceva Komlenić</i>	
IMPACT OF WHEAT AND BY-PRODUCTS OF FOOD INDUSTRY ON THE BISCUITS PROPERTIES	66
<i>Dijana Miličević, Gordan Avdić, Maida Selmić, Edina Hadžiomerović, Martina Andrejaš, Selma Mujdanović</i>	
PREDICTING THE TEXTURE OF COOKED PASTA BASED ON MECHANICAL PROPERTIES OF DRIED PASTA	73
<i>Dubravka Jambrec, Mladenka Pestorić, Olivera Šimurina, Bojana Filipčev, Nataša Nedeljković, Marijana Sakač, Anamarija Mandić</i>	
POSSIBILITIES OF APPLICATION OF EXTRUSION IN PRODUCTION OF NEW SNACK PRODUCTS	81
<i>Gordan Avdić, Dijana Miličević, Nedreta Mujkić, Maida Selmić, Azem Avdić</i>	

FORTIFICATION OF GLUTEN-FREE BISCUITS WITH BETAINE	92
<i>Bojana Filipčev, Jelena Krulj, Jovana Brkljača, Olivera Šimurina, Dubravka Jambrec, Marija Bodroža-Solarov</i>	
INTAKE OF GRAINS AND GRAIN BASED PRODUCT AND DIET QUALITY IN TODDLERS	99
<i>Ivana Rumbak, Kristina Petrčić, Tihana Kunić, Tea Ištvančić, Irena Colić Barić</i>	
HEMP PRODUCTS FOR FOOD AND MEDICINE USING	106
<i>Marie Hrušková, Ivan Švec</i>	
EFFECT OF FORTIFICATION WITH GREEN COFFEE BEANS ON CHELATING POWER OF WHEAT BREAD	113
<i>Urszula Gawlik-Dziki, Dariusz Dziki, Michał Świeca, Agata Durak, Jarosław Czyż</i>	
THE CORRELATION OF BUCKWHEAT GRAIN PHENOLIC COMPOUNDS WITH RESISTANCE TO MYCOTOXINS	123
<i>Ilona Keriene, Audrone Mankeviciene, Saulius Bliznikas, Danutė Jablonskyte-Rasce, Sigita Janaviciene, Ruta Cesnuleviciene</i>	
QUALITY AND ANTIOXIDANT PROPERTIES OF BREAD ENRICHED WITH FLOUR OBTAINED FROM ELICITED WHEAT SEEDLINGS	132
<i>Urszula Gawlik-Dziki, Dariusz Dziki, Michał Świeca, Łukasz Sęczyk</i>	
INFLUENCE OF GERMINATION TIME ON GRINDING CHARACTERISTICS AND ANTIOXIDANT ACTIVITY OF SPROUTED WHEAT	141
<i>Dariusz Dziki, Urszula Gawlik-Dziki, Marek Domin, Katarzyna Kozłowicz, Zbigniew Krzysiak</i>	
SURVEY OF β -GLUCANS IN DOMESTIC BARLEY'S VARIETIES	151
<i>Alojzije Lalić, Gordana Šimić, Vinko Krstanović, Kristina Mastanjević</i>	
IMMATURE HULL-LESS BARLEY GRAIN APPLICATION IN FUNCTIONAL DAIRY PRODUCT	159
<i>Jelena Zagorska, Daina Karklina, Ingmars Cinkmanis, Agnese Vecstaudza, Liga Skudra</i>	
INFLUENCE OF MALTING PROCEDURE ON THE QUALITY OF HULLESS BARLEY MALT	168
<i>Vinko Krstanović, Krešimir Mastanjević, Natalija Velić, Vedran Slačanac, Kristina Vacek, Goran Gagula, Kristina Mastanjević</i>	

ACORN FLOUR – NATURALLY GLUTEN FREE	177
<i>Mirjana Polimac, Daliborka Koceva Komlenić</i>	
WHEAT GRAIN CONSERVATION FOR HUMAN CONSUMPTION: CURRENT USE OF PESTICIDES IN ARGENTINA	182
<i>Teresa Fonovich, Valeria Sfara, Cristina Pérez-Coll</i>	
STARCH BREAKDOWN AND FORMATION OF SUGARS DURING TRITICALE GRAINS GERMINATION	188
<i>Tatjana Rakcejeva, Dace Klava, Ingmars Cinkmanis, Ruta Galoburda, Evita Straumite, Arta Kronberga</i>	
MONITORING THE SEED GERMINATION BY A NON-DESTRUCTIVE NEAR INFRARED (NIR) SPECTROSCOPY METHOD	201
<i>Mónika Bartalné-Berceli, Eszter Izsó, Juhász Réka, Szilveszter Gergely, András Salgó</i>	
MONITORING OF HEAT-TREATED WHEAT MILLING FRACTIONS BY NEAR-INFRARED SPECTROSCOPIC METHOD	215
<i>Eszter Izsó, Mónika Bartalné-Berceli, András Salgó, Szilveszter Gergely</i>	
DETERMINATION OF GLUTENIN AND GLIADIN LOCI IN CROATIAN WINTER WHEAT GERmplasm	225
<i>Sonja Marić, Marija Grgić, Sonja Petrović, Ivica Strelec, Sunčica Guberac, Vlado Guberac</i>	
A COMPARATIVE ANALYSIS OF TRADITIONAL AND E-MARKETING POTENTIALS IN THE BAKING INDUSTRY	234
<i>Branimir Dukić, Ivan Ružić, Stojanka Dukić</i>	
THE GOLDEN PATH OF BRANDING FLOUR AND BAKERY PRODUCTS FROM CROATIAN FIELDS	242
<i>Marija Vukobratović, Dubravka Živoder, Josipa Pavičić, Petra Tudor, Nada Barišić</i>	
PRESENCE OF A POTENTIALLY TOXIGENIC ASPERGILLUS SPECIES IN WHEAT FLOUR	248
<i>Dragana Plavšić, Gordana Dimić, Đorđe Psodorov, Ljubiša Šarić, Anamarija Mandić, Ivana Čabarkapa, Pavle Jovanov</i>	
AUTHOR INDEX	255

SCIENTIFIC PAPERS

IMAGE ANALYSIS TESTING OF BREAD WITH NON-TRADITIONAL PLANT RAW MATERIALS

UDC 664.66.016/.019 : 004.932.2

Ivan Švec, Marie Hrušková*

*University of Chemistry and Technology Prague, Department of Carbohydrates and Cereals,
Technická 5, Prague 6, Czech Republic*

**Corresponding author: Ivan.Svec@vscht.cz*

ABSTRACT

Within a laboratory baking test, performed according to the internal method of the Cereal Laboratory of UCT Prague, wheat bread types containing barley (30 %), chestnut and nopal (5-20 %) as well as chia (2.5-10.0 %) and teff flour (5-20 %) were prepared. Bread quality was described by specific bread volume and shape, crumb penetration and by texture attributes gained by image analysis (mean cell area, cells density). In amounts 5 % and 20 %, chestnut flour decreased bread volumes (from 347 to 215 ml/100 g), while nopal flour effect was significantly stronger (diminishing from 299 to 178 ml/100 g). Rate of crumb penetration correspondingly decreased from approx. 15.0 mm to 5.0 mm. Bread texture got also finer in both cases, mean cell area for e.g. wheat-chestnut bread dropped from 2.55 mm² to 1.53 mm², and cell count reversely rose from 27 to 37 cells/cm². On the other hand, chia and teff flours supported bread sizes rise and impact on crumb morphology was similar. Both chia and teff in recipe caused more open structure (cell areas around 2.6 and 2.1 mm², respectively) with statistically different cell densities (approx. 20 a 28 cells/cm², respectively). Combination of non-traditional materials with barley flour brought a diminishing of bread quality.

Keywords: composite flour, baking test, bread volume, crumb texture, image analysis

INTRODUCTION

Apart to wheat flour quality as a basic raw material in the bakery industry, other recipe components together with course of dough preparation and baking procedure determine final product appearance and properties (Magnus *et al.* 1997; Lassoued *et al.*, 2007). According to increasing nutrition trends in bread production, non-traditional cereals as well as other crops became popular in last twenty years. Alternative cereals are represented by e.g. spelta or barley; the latter underwent a renaissance of its usage in food industry, correspondingly to recent healthier nutrition trend in food production. Changes in volume and crumb porosity of bread prepared from different Polish spelt hybrids were evaluated by Ceglińska (2003). Gill *et al.* (2002) determined characteristics of wheat-barley bread containing regular and waxy barley flour. They reported 15 % substitution

produced breads with bigger loaf volume and softer crumb in case of recipe with regular barley flour. Effect of barley β -glucans characterised by low and high molar weight on bread properties analysed Skendi *et al.* (2010) – addition of β -glucans of higher molar weight was more effective in increasing the specific bread volume and reducing the crumb firmness. Besides that, the bread crumb colour got darker and texture became more open (coarser).

Forgotten crops were daily eaten by ancient civilisations, as chia or nopal by Aztecs and Incas. Teff grass is domestic in Ethiopia highlands, and it belongs to staple food there. Chestnut tree and fruit are characteristic for South Europe region, where belongs to season food and which has own festival tradition in early autumn. All mentioned plant raw materials could contribute to nutritional enhancement of traditional bakery products – e.g. chia has high content of fat involving unsaturated fatty acids in significant level, easy digestible proteins, soluble dietary fibre and minerals (Reyes-Caudillo *et al.* 2008; Ayerza and Coates 2011, Ciftci *et al.* 2012, Luna Pizzaro *et al.* 2013). Effect of chia on crumb structure of sweet bread evaluated Farrera-Rebollo *et al.* (2012) – addition of 12 % of chia wholemeal into recipe lead to significant changes in pores size and distribution, while a half chia dosage had not such effect (texture comparable to wheat control). Nopal addition into cake formula brought a gradual increase of cake hardness and a decrease in organoleptic scores (Ayadi *et al.*, 2009). Besides to specific volumes of three types of wheat-teff bread comparable to control, teff significantly increased protein and dietary fibre contents, as well as introduced a substantive amount of iron (Alaunyte *et al.*, 2012). Addition of chestnut flour into wheat bread recipe had a similar impact as nopal flour – higher fiber and sugar contents in chestnut flour caused a step-by-step volumes lowering and crumb darkening of bread prepared from two wheat-chestnut flour blends 80:20 and 50:50 (w:w, respectively; Dall'Asta *et al.*, 2013).

The aim of this work was to evaluate the baking quality and texture within sets of wheat bread enriched by chestnut and nopal flour and of wheat-barley bread containing chia or teff wholemeal. To verify relations between bread and crumb morphology data, correlation matrix was calculated. For distinguishing of influence of non-traditional plant materials and addition level, hierarchical cluster analysis was used.

MATERIALS AND METHODS

Sample of white wheat flour (WF), used as a base for bi- and tri-composite blends, was delivered by the Czech commercial mill Delta Prague. It is characterised by protein content 11.2 %, Zeleny value 50 ml and Falling Number 341 s. Barley flour (BF) was delivered by the Czech commercial mill Křesín, and protein content was evaluated as 9.23 %. Both cereal flour types were mixed together in ratio 70:30 (w/w, abbreviation WBF), respectively.

Chia seed samples (white CH1, black CH2) were also bought in specialised shop (seeds origin in Mexico). Chia wholemeal was prepared by using blade grinder Concept KM 5001; one-operation seeds weight was 50 g and disintegration time approx. 1 min. White

and dark seeds chia wholemeal CH1 and CH2 were later characterised by protein content 20.17 % and 20.20 %, respectively. The Directive 2013/50/EU guides of chia usage in bakery products, allowing 10 % in recipe maximally. Teff flour of white and brown type (T1 and T2, respectively) containing 10.0 % of proteins was provided by Tobia Teff Ltd. (London, GB; seeds origin in Ethiopia). Nopal flour (N) was produced by Salvia Paradise Company (Kvaň, CZE), and chestnut one by Sonnentor GmbH company (Zwetill, AUT).

Bread preparation and its characteristics assessment were described in previous work (Švec and Hrušková, 2004). Leavened dough was prepared by using of farinograph, following the formula: flour – 100 %, yeast – 4.0 %, salt – 1.7 %, sugar – 1.5 %, fat – 1.0 % (amount of ingredients on flour base) and distilled water needed for preparation of dough characterised by consistency of 600 ± 20 Brabender's units. Commercial French-type yeast "Fala" and the Czech margarine "Perla" (fat content 40 %) were used. Dough fermentation and leavening took 50 and 45 min in thermostat (30 °C, RH 95 %); 70 g dough pieces were moulded manually, placed on a baking plate. Baking 14 min long was performed in a laboratory oven (Bakery Research Institute, PL) preheated to 240 °C, steamed immediately after baking plate insertion. After two-hour cooling at laboratory condition, the specific volume and the shape (height-to-diameter ratio) was determined in triplicate. For a crumb compactness evaluation, crumb samples (of 35 mm in height and 30 mm in diameter) were cut out of the bun halves centre. The penetrometer PNR-10 (Petrotest Instruments, Germany) equipped with stainless steel 25 mm hemisphere in a screw holder was employed (total weight 150 g), and the penetration depth was determined five times. Selected bread half was scanned in a darkroom and printed on office xerox Canon iR1210 under the lowest contrast possible. Bread cut area was then measurement with the help of the digital planimeter Plancom KP-92N (Koiyumi, JAP).

Image analysis was performed by using NIS Elements AR v2.3 (Laboratory Imaging, Prague, CZE) from grey-scale paper pictures used also for bread cut area evaluation. Evaluated texture attributes were mean cell area, total cell number, cell density (cells/cm²) and area fraction (ratio of total cell area to measured bread cut area). Data statistical pre-treatment is depicted in previous paper (Hrušková *et al.*, 2013).

Accuracy of the methods used for bread quality evaluation was adopted from bachelor theses lead in the Cereal laboratory research (University of Chemistry and Technology Prague), and determined standard deviations are appointed to data tables.

Statistical comparison of effects of flour blend and non-traditional material addition on bread quality was processed by hierarchical cluster analysis in Statistica 7.1 software (StatSoft Inc., Tulsa, USA). Ward's method of clustering and Manhattan (City-block) metrics were applied to distinguish tested samples according to bread formula used. The specific volume of bakery product is clearly preferred mark of quality – its importance was stressed by measured data processing in a non-standardized form. Maintaining different scales of observed features, 7-space cloud of samples was deformed (extended) along the specific bread volume axis (the highest values within the dataset).

RESULTS AND DISCUSSION

Table 1. Characteristics of wheat composite bread

a) addition of chestnut and nopal flour (C, N)

Bread sample (flour blend)	Addition level (%)	Spec. bread volume (ml/100 g)	Bread shape* (1)	Crumb penetration (mm)	Bread cut area (cm ²)
WF	-	341	0.53	20.8	27.1
WF+C	5	347	0.52	16.8	26.3
	10	253	0.60	10.3	28.4
	15	230	0.57	5.9	23.3
	20	215	0.58	5.3	22.8
WF+N	5	299	0.61	13.4	30.1
	10	260	0.60	13.4	29.4
	15	230	0.62	8.8	25.1
	20	178	0.70	5.5	28.0

b) addition of chia and teff wholemeal (Ch1, T1 and Ch2, T2 – white/dark seeds wholemeal)

WF	-	341	0.53	20.8	27.1	
WBF	-	233	0.57	4.2	23.8	
WBF	+Ch1	5	176	0.59	5.4	25.6
		10	184	0.63	6.7	23.8
	+Ch2	5	154	0.59	4.5	25.2
		10	169	0.68	4.3	23.6
WBF	+T1	5	211	0.42	5.5	19.3
		10	226	0.40	5.9	18.7
	+T2	5	179	0.46	5.4	19.5
		10	199	0.42	6.0	22.8
Standard deviation		14.9	0.02	0.58	0.01	

WF - wheat flour, WBF - wheat-barley flour blend 70:30 (w:w); *height-to-diameter ratio

Baking test results

Table 1 summarises characteristic of laboratory baked bread prepared according to 18 formulas. Specific volume of control wheat bread reached satisfying level of 341 ml/100 g, and its vaulting (height-to-diameter ratio) was somewhat lower than empirical optimum 0.58-0.60. Crumb penetration equal to 20.8 mm signifies rather open porosity and easy mouthful palatability. An average cut area (27.1 cm²) corresponds to determined buns volume.

For bread from bi-composite flour, presence of both chestnut and nopal flour in recipe meant an overall lowering of the products quality (Table 1a). Bread sample WF5C size was comparable to control, but higher dosages of chestnut flour caused a verifiable diminishing about 40 % in total. Negative impact of nopal flour had a larger extent, total decrease in specific bread volume reached approx. 50 %. All bi-composite breads were described by better shape than wheat control, but acceptable organoleptic properties of crumb could be addressed only to ones described by penetration higher than 10 mm.

Recipe enhancement by barley flour demonstrated a major influence on bread properties change, buns size fell to approx. 66 % of the control WF ;one. Product shape was partially improved, but crumb firmness increased to unacceptable level (Table 1b). Fortification by chia lead to further weakening of gluten skeleton in dough, reflected in lower bread volumes. With respect to measurement accuracy of the feature, samples containing white and dark chia wholemeal could not be considered as different. Chia in recipe supported bread vaulting, but presence of barley flour predispose tough character of those breads crumb (Table 1b). Teff wholemeal, especially in white form, had an improving effect on bread volume due to botanical affinity of teff and wheat (both plants classified into the *Grass – Poaceae* family). In teff proteins, however, extensible structures prevail to elastic ones (Hrušková and Švec 2013), as revealed significantly worse vaulting of those bread specimens (buns clearly lower in height and reversely in diameter). Crumb compressibility of all tri-composite samples was somewhat better than one of wheat-barley bread, but measured levels still fall in unacceptable category (penetration lower than 10 mm). As affected by recipe modification, bread cut areas corresponded to determined bread volumes (based on geometric connection) in majority of occasions.

Image analysis of crumb morphology

Crumb texture of could be primarily described by two basic parameters only, i.e. the mean cell area and the cell density, which have a reversal reciprocal relationship. For all tested bread items, Figure 1 confirms that link and demonstrates influence of analysed plant raw materials on bread crumb appearance. In terms of image analysis data, borders of the enhanced bread set represents samples WF5N and WBF5T2, characterised by mean cell areas 1.289 and 2.561 mm² and cell densities 39 and 26 pores/cm², respectively. In the plot, three sample groups could be identified as statistically diverse (from right down bottom corner to left upper corner). The first covered the WF only, whose crumb exhibited open structure character – the highest cell area and the lowest cell density (2.922 mm² and 23

pores/cm², respectively). The second one is the most numerous – it contains the WBF control, WF+N foursome, both Ch1-tri-composite breads and a sample pair with lower additions of chestnut flour (median values 2.103 mm² and 28 pores/cm²). For the third group, respective values were 1.555 mm² and 34 pores/cm².

Crumb of bi-composite bread got gradually closer, and effect of chestnut and nopal flour seem to be comparable in the both texture attributes. A partial difference could be noticed in cell densities of bread containing 15 % or especially 20 % of these alternative flours – chestnut flour supported finer texture when the mentioned addition levels were applied (densities 37 vs. 31 pores/cm²).

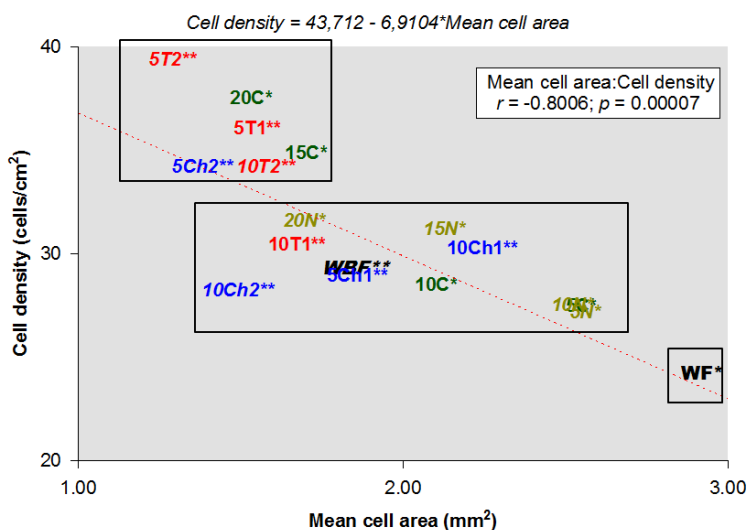

Figure 1. Influence of non-traditional plant raw materials on basic attributes of bread crumb texture. (WF, WBF – wheat and wheat barley flour (*, ** respectively, identify base of composite flour); C, N – chestnut and nopal flour; Ch1, Ch2, T1, T2 – white and dark chia/teff seeds wholemeal. Sample codes example: 10C* – WF bi-composite flour containing 10% of chestnut flour, 5Ch2** – WBF tri-composite flour containing 5% of dark chia seeds wholemeal)

Barley flour in bread recipe also affected crumb morphology negatively, the mean cell area decreased approx. about one third (from 2.92 to 1.85 mm²; Figure 1) and cell density increased about from 23 to 28 pores/cm² (comparison to WF bread). That change predisposed crumb appearance of further bread samples based on this cereal premix – more open character of WBF bread crumb became step-by-step closer, depending on either crop type (chia, teff) or wholemeal type (white, brown). In case of chia tri-composite breads, the mean cell areas determined correspond well with the specific bread volumes. Incorporating of white chia seeds wholemeal allowed huge rise of pores during moulded

dough pieces leavening (e.g. 2.24 mm² vs. 1.49 mm² for WBF10Ch1 and WBF10Ch2 bread). Perhaps due to different pore areas distribution in T1-tri-composite breads, somewhat higher density of cells with middle high mean cell area ensured increase of bread volumes. Moreover, bread sample prepared from blend WBF10T2 was depicted by crumb morphology close to both T1 counterparts (Figure 1).

Correlation analysis

Correlation analysis signified known relations between bread and crumb characteristics (Table 2) – bun volume is built from numerous rows of small, middle and large area cells (i.e. total area of cells). The crumb penetration was the most representative bread macro-feature (Švec and Hrušková 2010); it was linked to five of the six bread quality and porosity parameters. In comparison to the specific bread volume, relationships of the respective pair correlations were tighter just for crumb penetration characteristics (e.g. 0.90 vs. 0.83 in case of mean cell area). Insignificance of all correlations of the total cell number to other determined features could be explained by its partial independence on bread cut area; when related to area of measured field (expressed then as the cell density), all expected bounds are revealed out on likelihood $P = 99\%$ at least (within the expected link to the mean cell area, presented in Figure 1).

Table 2. Relationships between bread characteristics and crumb features

Parameter	Specific bread volume	Crumb penetration	Bread cut area	Mean cell area	Total cell number	Cell density	Area fraction
Specific bread volume	1						
Crumb penetration	0.91***	1					
Bread cut area	ns	0.57*	1				
Mean cell area	0.83***	0.90***	0.68**	1			
Total cell number	ns	ns	ns	ns	1		
Cell density	-0.59**	-0.66**	-0.66**	-0.80***	ns	1	
Area fraction	0.73***	0.80***	0.55*	0.86***	ns	ns	1

*, **, *** - pair correlations significant at $P = 95\%$, 99% and 99.9% , respectively; ns – non-significant.

Provable correlations of the area fraction confirmed the idea about linkage between crumb structure and bread volume mentioned supra – the Pearson $r = 0.73$ (and 0.80 to crumb penetration) were provable on level $P = 99.9\%$.

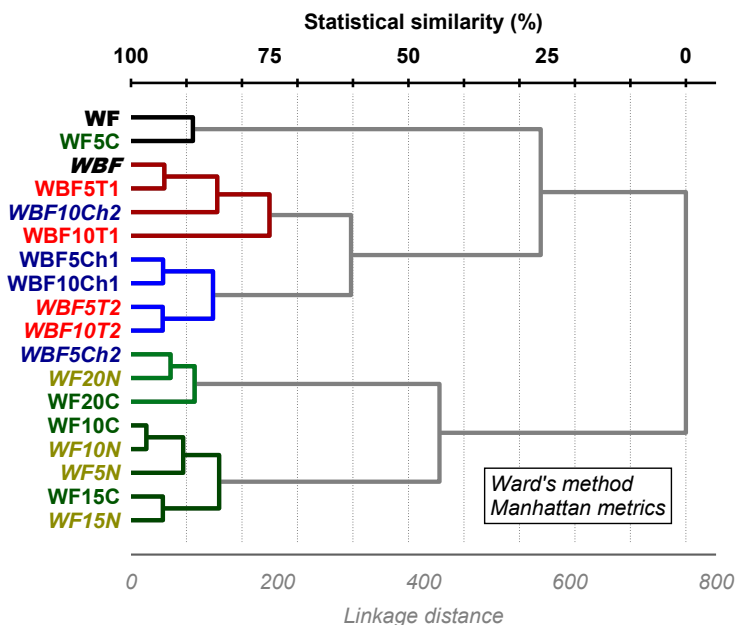

Figure 2. Statistical similarity of wheat, bi- and tri-composite flour bread samples, based on clustering of bread features and crumb attributes (WF, WBF – wheat and wheat barley flour; C, N – chestnut and nopal flour; Ch1, Ch2, T1, T2 – white and dark chia/teff seeds wholemeal. Sample codes example: WF10C – wheat bi-composite flour containing 10% of chestnut flour, WBF5Ch2 – wheat tri-composite flour containing 5% of chia dark seeds wholemeal)

Similarity of bread formula tested

A constructed tree-diagram confirms importance of flour composite base on overall bread quality – samples were primarily separated into subgroups of WF blends and WBF counterparts (Figure 2). Further conjoining has predominantly run according to addition level within the WF group (e.g. pair WF15C–WF15N) and according to alternative flour type with the WBF group (e.g. cluster WBF5Ch1–WBF10Ch1).

As was mentioned above, 5% of chestnut flour had a minimal influence on bread and crumb properties, thus WF5C sample form a primary cluster with WF control. Such effect could be seen also in pair WBF–WBF5T1 – in both mentioned pairs, statistical similarity overcame 90 %. Further expected linkage occurred between WF20N and WBF5Ch2 –

lowering of WF baking quality by addition of 20 % N was comparable to combined effect of barley flour and dark chia seeds wholemeal.

CONCLUSIONS

The present work contributes to evaluation of wheat flour and wheat-barley bread properties and texture as influenced by non-traditional plant raw materials. Bread prepared from wheat-chestnut and wheat-nopal blends was characterised by gradually lowering volume, with stronger negative impact of the latter alternative flour. Correspondingly to that, appearance of bi-composite bread variants texture was changed from rather open to core closed one (decrease in the mean cell areas, increase in cell densities).

Addition of barley flour in bread recipe presents a nutritional benefit in terms of increase of dietary fibre level, and its 30 % dosage was found ad still acceptable in bakery technology as well as in consumer quality. Control wheat bread size was lowered about 33 %, and mean cell area was diminished from 2.92 to 1.85 mm². Cell density significantly increased reversely from 23 to 38 pores/cm², and such bread mouthful became tougher to palate. Addition of chia or teff have a secondary influence on bread quality, a partial improvement could be addressed to white seeds chia/teff wholemeal in bread recipe – texture of those bread variants was depicted by cells approx. 1.70 mm² large with densities around 32 pores/cm².

For a praxis, chestnut or nopal flour could be recommended for substitution of 10 % - 15 % of wheat flour, and chia of teff wholemeal should be added into wheat-barley flour premix on level 10 %.

ACKNOWLEDGEMENTS

The study was conducted under the grant No QI11 B053 of the NAZV, Czech Republic.

REFERENCES

- Alaunyte, I., Stojceska, V., Plunkett, A., Ainsworth, P., Derbyshire, E. (2012): Improving the quality of nutrient-rich teff (*Eragrostis tef*) breads by combination of enzymes in straight dough and sourdough breadmaking, *J. Cereal Sci.* 53(2), 192-197. <http://dx.doi.org/10.1016/j.jcs.2011.09.005>
- Ayadi M.A., Abdelkaksoud W., Ennouri M., Attia H. (2009): Cladodes from *Opuntia ficus-indica* as a source of dietary fiber: Effect on dough characteristics and cake making. *Ind. Crops Prod.* 30(1), 40-47. <http://dx.doi.org/10.1016/j.indcrop.2009.01.003>
- Ayerza, R., Coates, W. (2011): Protein content, oil content and fatty acid profiles as potential criteria to determine the origin of commercially grown chia (*Salvia hispanica* L.). *Ind. Crops Prod.* 34(2): 1366-1371. <http://dx.doi.org/10.1016/j.indcrop.2010.12.007>

- Ceglińska, A. (2003). Technological value of a spelt and common wheat hybrid. *Electronic J. Polish Agri. Universities* 6(1), #2, <http://www.ejpau.media.pl/volume6/issue1/food/art-02.html>. Accessed September 26, 2015.
- Ciftci, O.N., Przybylski, R., Rudzinska, M. (2012): Lipid components of flax, perilla, and chia seeds. *Eur. J. Lipid Sci. Technol.* 114: 794-800. . <http://dx.doi.org/10.1002/ejlt.201100207>
- Ferrera-Rebollo, R.R., Salgado-Gruz, M., Chanona-Perez, J., Gutierrez-Lopez, G.F., Alamilla-Beltran, L., Calderon-Dominguez, G. (2012): Evaluation of image analysis tools for characterization of sweet bread crumb structure. *Food Bioproc. Technol.* 5(2), 474-484. <http://dx.doi.org/10.1007/s11947-011-0513-y>
- Gill, S., Vasanthan, T., Ooraikul, B., Rosnagel, B. (2002). Wheat bread quality as influenced by the substitution of waxy and regular barley flours in their native and cooked forms. *J. Cereal Sci.* 36, 239-251. <http://dx.doi.org/10.1111/1541-4337.12064>
- Hrušková M., Švec I. (2013): Tef – nejmenší obilovina na světě. [Teff – the smallest cereal all over the earth]. *Mlynářské noviny* 146(2), 10-12. [In Czech]
- Hrušková M., Švec I., Sümeyye Inanoglu (2013): Texture of bread from wheat/hemp composites, *Cereal Technol.* 67(2), 70-79.
- Lassoued, N., Babin, P., Valle, D.G., Devaux, M.F., Réguerre, A.L. (2007). Granulometry of bread crumb grain – contributions of 2D and 3D image analysis at different scale. *Food Res. Internat.* 40, 1087-1097. <http://dx.doi.org/10.1016/j.foodres.2007.06.004>
- Luna Pizzaro, P., Lopes Almeida, E., Sammán, N.C., Chang, Y.K. (2013): Evaluation of whole chia (*Salvia hispanica* L.) flour and hydrogenated vegetable fat in pound cake. *LWT – Food Sci. Technol.* 54, 73-79. <http://dx.doi.org/10.1016/j.lwt.2013.04.017>
- Magnus, E.M., Bråthen, E., Sahlström, S., Færgestad, E. M., Ellekjær, M.R. (1997): Effects of wheat variety and processing conditions in experimental bread baking studied by univariate and multivariate analyses. *J. Cereal Sci.* 25(3), 289-301. <https://dx.doi.org/10.1006/jcrs.1996.0094>
- Reyes-Caudillo, E., Tecante, A., Valdivia-Lopez, M.A. (2008): Dietary fibre content and antioxidant activity of phenolic compounds present in Mexican chia (*Salvia hispanica* L.) seeds. *Food Chem.* 107, 656-663. <https://dx.doi.org/10.1016/j.foodchem.2007.08.062>
- Švec I., Hrušková M. (2010): Evaluation of wheat bread features. *J. Food Eng.* 99(4), 505-510. <http://dx.doi.org/10.1016/j.jfoodeng.2009.09.022>
- Švec, I., Hrušková, M. (2004). Image data of bread crumb structure from flour of Czech spring wheat cultivars. *Cz. J. Food Sci.* 22(4), 133-142.

RESISTANCE OF SOURDOUGH STARTER CULTURES TO FREEZING

UDC 664.66.03

Saša Ajredini, Dubravka Novotni, Nikolina Čukelj, Marina Krpan, Mirjana Hruškar, Duška Ćurić*

University of Zagreb, Faculty of Food Technology and Biotechnology,
Pierottijeva 6, 10000 Zagreb, Croatia

*Corresponding author: dcuric@pbf.hr

ABSTRACT

The aim of this study was to examine tolerance of lactic acid bacteria and yeast strains, usually included in sourdough fermentation, to blast and vacuum freezing. Freezing was conducted in water suspensions of microorganisms and rye flour (10 % m/m), with or without addition of trehalose (1% m/m) as a cryoprotectant, and CFU was determined before and after freezing. This study included strains *L. fermentum*, *L. parabrevis*, *L. plantarum*, *L. reuteri*, *L. sanfranciscensis*, *W. cibaria*, *S. cerevisiae*, and commercial starter cultures Saff Levain LV1 (*L. brevis*, *L. casei*, *S. cerevisiae*) and LV4 (*L. brevis*, *S. chevalieri*). Results showed that influence of applied freezing methods and trehalose addition on microorganism survival was strain specific. Single strain cultures showed to be more resistant to freezing than commercial starter cultures. LV4 *S. chevalieri* was the most sensitive with 5-log CFU reduction after vacuum freezing without trehalose addition. With trehalose addition there was no CFU reduction of, LV4 *S. chevalieri* yeast and that was the only case of significant positive effect of trehalose. According to the results, *L. reuteri* and *W. cibaria* appeared as the most suitable for freezing with at least 50% survival and the lowest variability of survival depending on freezing conditions. These results of microbial survival need confirmation in sourdough freezing environment.

Keywords: lactic acid bacteria, yeast *Saccharomyces cerevisiae*, vacuum freezing, sourdough starter cultures, trehalose

INTRODUCTION

With a long tradition, the use of sourdough today plays an important role in bread production. It improves the technological properties of dough, nutritional and organoleptic characteristics of bread and prolongs bread shelf life. Sourdough is a mixture of flour and water fermented by lactic acid bacteria (*LAB*), most heterofermentative strains (De Vuyst and Neysens, 2005). *LAB* are predominant in the sourdough and often coexist with yeasts (Gobbetti *et al.*, 2005). According to microbiological studies, it was found more than 50 strains of *LAB*, mostly genus *Lactobacillus* and more than 20 species of yeasts, especially the genera *Saccharomyces* and *Candida*, which appear in this ecological niche (De Vuyst and Neysens, 2005). Traditional sourdough is obtained by spontaneous

fermentation, but in recent years the use of specific microbial starter cultures is rising in order to control the fermentation process and assure continuous product quality.

Freezing can be applied as a method for prolongation of the sourdough shelf life, but it can cause damage to the microorganism cells – cell membranes and proteins, induce DNA denaturation and reduce their survival (Nakamura *et al.*, 2009). The mechanical damage of cellular structures is influenced by the ice crystals development (Fonseca *et al.*, 2001) and water transport (Fowler and Toner, 2005). Severity of freezing mediated cell damage depends on various factors such as strain, cell size and shape, growth phase, incubation time, medium composition, pH, osmolarity, cell composition, freezing medium composition, freezing speed, storage time and temperature, etc. (Hubálek, 2003). Slow and rapid freezing induce different effect on cell damage and their survival. Upon slow freezing formation of extracellular ice occurs causing an increase in extracellular osmolality and leads to cell dehydration which causes cell damage (Fonseca *et al.*, 2001; Nakamura *et al.*, 2009). Fast freezing cell damage is attributed to the intracellular ice formation (Fonseca *et al.*, 2001), which occurs due to a lack of time for the transmission of intracellular water through membrane (Nakamura *et al.*, 2009; Takagi *et al.*, 2000; Santivarangkna *et al.*, 2008). Intracellular ice formation causes greater damage to living cells compared to extracellular ice formation and cell dehydration (Nakamura *et al.*, 2009). Vacuum cooling and freezing are based on the water evaporation at the lower pressure and consequent heat removal from the system (Kasper and Friess, 2011). Water freezing occurs after the pressure in the vacuum chamber drops below 6 mbar which is the equilibrium vapour pressure at 0 °C, and it freezes from the surface to the bottom. In the initial freezing phase thin surface ice is formed (Cheng and Lin, 2007; Kramer *et al.*, 2002; Liu and al., 2005), but it is destroyed during boiling process resulting with irregular shape (Cheng and Lin, 2007).

Although it is sometimes possible to achieve high survival of frozen microorganisms without the addition of protective additives, their presence contributes to a significant increase in survival rate (Hubálek, 2003). Trehalose is natural cryoprotective agent present in plants and yeast cells, while its synthesis was not observed among *LAB* (Zayed and Roos, 2004).

The aim of this study was to examine the influence of vacuum and blast freezing on survival rate of six single strain microorganisms, two commercial mixed starter cultures and baker's yeast used for sourdough production. Freezing has been conducted in rye flour suspensions with and without the addition of trehalose as cryoprotectants. With regard to our knowledge, no research paper has been published that included an experiment with combination of above specified microbial cultures and freezing media.

MATERIALS AND METHODS

Microorganisms

Experiments for determining the influence of vacuum and conventional freezing on microorganism survival rate were conducted with strains *Lactobacillus parabrevis* (LMG 11984), *Lactobacillus plantarum* (LMG 6907), *Lactobacillus reuteri* (DSM 20016), *Lactobacillus*

fermentum (DSM 20052), *Lactobacillus sanfranciscensis* (LMG 16002), *Weissella cibaria* (DSM 15878) purchased from DSMZ, mixed starter cultures LV1 and LV4 (Saf Levain, Lesaffre), and commercial fresh baker's yeast *Saccharomyces cerevisiae* (Di-go, Kvasac Ltd).

Culture preparation

Bacterial cultures *Lactobacillus parabrevis*, *Lactobacillus plantarum*, *Lactobacillus reuteri*, *Lactobacillus fermentum* and *Weissella cibaria* were propagated in MRS broth with Tween 80 (Biolife, Italy), which was prepared according to the manufacturer's instructions and sterilized by autoclaving (121 °C for 15 minutes). *Lactobacillus sanfranciscensis* was propagated in SD broth containing 20 g of maltose (D(+)-maltose monohydrate, 90 %, Acros Organics), 3 g of yeast extract (Biolife), 6 g of tryptone (Biolife) and 15 ml fresh yeast extract. Fresh yeast extract was prepared by autoclaving 20% (m/m) commercial fresh baker's yeast suspension in distilled water at 121 °C for 30 minutes. Such suspension was kept overnight at 4 °C, then decanted and the supernatant was purified by centrifugation. To prepare the SD broth, all the listed ingredients were weighed in a bottle, than distilled water was added, pH was adjusted 5.6 with 10% lactic acid, and distilled water was added to a volume of 1 l. The medium was stirred until complete dissolution of all the ingredients and then sterilized by autoclaving (121 °C for 15 minutes).

Laboratory propagation of *LAB*

In the first stage of propagation, single strain culture was aseptically transferred from agar slant with inoculation loop to a test tube with 10 ml broth and incubated for 24 ± 2 hours at 30 ± 1 °C. In the second stage, 1 ml of liquid culture medium with the bacterial culture from the first phase was aseptically transferred into a test tube with 10 ml of fresh broth and incubated for 24 ± 2 hours at 30 ± 1 °C. Grown *LAB* culture from five second phase tubes were the inoculum for 200 mL of medium in a third phase and incubation was carried out for 92 ± 2 hours at 30 ± 1 °C. After third stage of propagation, the medium was resuspended and transferred to 50 ml cuvettes and centrifuged at 3000 RPM for 10 minutes. Harvested biomass was washed twice with 50 ml of sterile water, and finally resuspended in 100 ml of sterile water.

Commercial starter cultures and fresh baker's yeast preparation

Fresh baker's yeast and starter cultures LV1 and LV4 were rehydrated as follows: 1 g of yeast or starter culture was weighted in 200 ml flask and 100 ml of sterile pre-heated water (37 °C) was added. The flask was closed and suspension was thoroughly mixed. The flask was then placed in a water bath at 37 °C for 15 minutes without stirring, and then 15 min with stirring.

Sample preparation

Microorganism suspensions were prepared with the addition of rye flour (T-1250, Granolio), with and without the addition of trehalose (Trehalose 1640, Cargill). 1.00 g rye flour was weighed in 50 ml tubes and 0.10 g of trehalose was optionally added. 5 ml of microorganism suspension was then added, suspension was resuspended and left foam formed during resuspending to settle after which volume was made up to 10 ml with sterile water.

Freezing process

The vacuum freezing process was carried out in the stainless steel vacuum chamber (width 20 cm, height 29 cm) with the laboratory vacuum pump (LVS 105 T – 10 ef, ILMVAC GmbH, Germany) which achieves pressure of at least 2 mbar. The vacuum chamber had a double wall with connections to high-precision temperature controller (CC 515, Huber, Germany) that maintains the desired temperature by silicon oil circulation inside the wall. Temperature in vacuum chamber during the freezing was -30 °C. During vacuum freezing temperature drop was monitored using a temperature probe (HYP1-30-1/2-TG-SPMW-M, Omega, USA) connected to a data logger (OM-CP-QUADTEMP-A, Omega, USA) and pressure drop was monitored on the pump display. Vacuum freezing process is shown in Fig. 1.

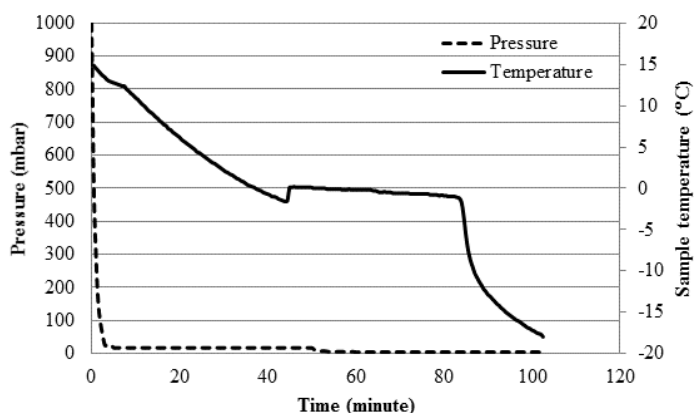

Figure 1. Vacuum freezing process

During freezing, pressure drop was different depending on samples. As a result of low pressure, sample suspension begun to boil which was accompanied by foaming. To prevent sample loss during boiling, pressure was lowered to the minimum with occasional constant pressure mode or pressure releases. Calculated cooling rate during

vacuum freezing process was 0.3 °C/min. Blast freezing process was conducted in a blast freezer (Everlasting, Italy) with blast air temperature -30 °C during which sample suspension temperature was monitored by built-in probe. Blast freezing process was shown in Fig. 2. Calculated cooling rate during blast freezing process was 0.8 °C/min. Freezing processes were carried out until sample core temperature did not reach -18 °C. After freezing process samples were stored at -18 °C for 7 days, after which they were thawed at room temperature and a number of microorganism living cells was determined.

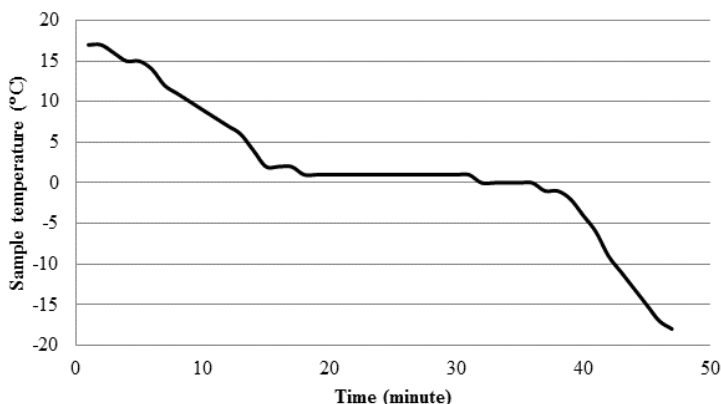

Figure 2. Blast freezing process

Enumeration of bacteria and yeast

Colony forming units of *Lactobacillus parabrevis*, *Lactobacillus plantarum*, *Lactobacillus reuteri*, *Lactobacillus fermentum*, *Weissella cibaria*, LV1 and LV4 lactic acid bacteria viability were determined on the MRS agar with Tween 80 (Biolife) prepared according to the manufacturer's instructions.

For determination of *Lactobacillus sanfranciscensis* viability the SD agar was used. SD agar was prepared identically as SD broth with addition of 15 g of agar agar (Kemika). Yeast viability was determined on YM agar (Difco TM, YM Agar, Becton, Dickinson and Company) prepared according to the manufacturer's instructions.

Sample suspension serial dilutions were prepared in sterile water and 1 ml aliquots of the appropriate dilutions (three dilutions were used for each sample) were plated in duplicate on appropriate agar.

To plates for LAB determination one drop of cycloheximide solution (Fluka) was added to prevent the growth of yeasts, while to plates for yeast determination one drop of 1% (m/V) oxytetracycline solution was added to prevent the growth of LAB. Also, to plates for determination of LAB viability, after solidification of agar layer, another thin layer of agar was added to simulate anaerobic growth conditions.

Plates were incubated at 30 °C for 72 h. After incubation, the number of colonies was counted and expressed as CFU/ml. The number of the CFU/ml was compared with their initial number before the freezing process showed in Table 1 (measured by the same method) and the results were expressed in logarithmic scale (\log_{10} CFU/ml).

Table 1. CFU/ml in initial suspension before freezing process

Microorganism	CFU/ mL
<i>L. brevis</i> , <i>L. casei</i> (LV1)	$7.75 * 10^6 \pm 1.12 * 10^7$
<i>L. brevis</i> (LV4)	$3.02 * 10^8 \pm 3.51 * 10^8$
<i>S. cerevisiae</i> (LV1)	$2.27 * 10^7 \pm 1.83 * 10^7$
<i>S. chevalieri</i> (LV4)	$2.17 * 10^7 \pm 7.71 * 10^6$
<i>S. cerevisiae</i>	$2.37 * 10^7 \pm 1.77 * 10^7$
<i>L. plantarum</i>	$1.98 * 10^8 \pm 1.43 * 10^8$
<i>L. reuteri</i>	$1.69 * 10^9 \pm 5.51 * 10^8$
<i>L. fermentum</i>	$2.28 * 10^6 \pm 8.38 * 10^5$
<i>L. parabrevis</i>	$1.45 * 10^7 \pm 1.82 * 10^6$
<i>W. cibaria</i>	$3.73 * 10^7 \pm 1.14 * 10^7$
<i>L. sanfranciscensis</i>	$1.36 * 10^8 \pm 7.38 * 10^6$

RESULTS AND DISCUSSION

The aim of this study was to examine the survival rate of different strains of LAB and yeasts after vacuum and blast freezing in rye flour suspension with and without trehalose addition. Microbial survival after freezing process is influenced by large number of factors including cell characteristics, composition of freezing medium, cooling rate, temperature at the end of freezing, etc. (Hubálek, 2003). Vacuum and blast freezing applied in this research was characterised by slow cooling rate, 0.3 °C/min and 0.8 °C/min, respectively. Comparing freezing processes, survival of *L. brevis* (LV4), *S. cerevisiae* (LV1), *S. chevalieri* (LV4), *L. fermentum*, *L. parabrevis* in suspension with trehalose, and *S. cerevisiae* and *L. fermentum* in suspension without trehalose was greater after vacuum freezing. Survival of *L. brevis*, *L. casei* (LV1), *L. plantarum*, *S. cerevisiae* in suspension with trehalose, and *S. chevalieri* (LV4), *L. plantarum*, *L. parabrevis* in suspension without trehalose was greater after blast freezing. Difference between freezing conditions was not observed for *L. brevis*, *L. casei* (LV1), *L. brevis* (LV4), *S. cerevisiae* (LV1) in suspension without trehalose, and *L. reuteri*, *W. cibaria*, *L. sanfranciscensis* in both suspensions. According to Santivarangkna *et al.* (2008), an optimal cooling rate should be low enough to avoid formation of intracellular ice, and also high enough to minimize the solution hyperosmolarity effect. For instance, Dumont *et al.* (2003) reported high survival rate of *S. cerevisiae* when low and very high cooling rates were applied (>10 °C/min and 30000 °C/min, respectively), in contrast to low survival

rate after high cooling rate application (10-1000 °C/min). The optimal cooling rate of *LAB* varies between specific strains. Cell freezing damages are for some strains lower after fast freezing, for some strains after slow freezing, and for some strains there is no difference in viability after slow or fast freezing (Santivarangkna *et al.*, 2008).

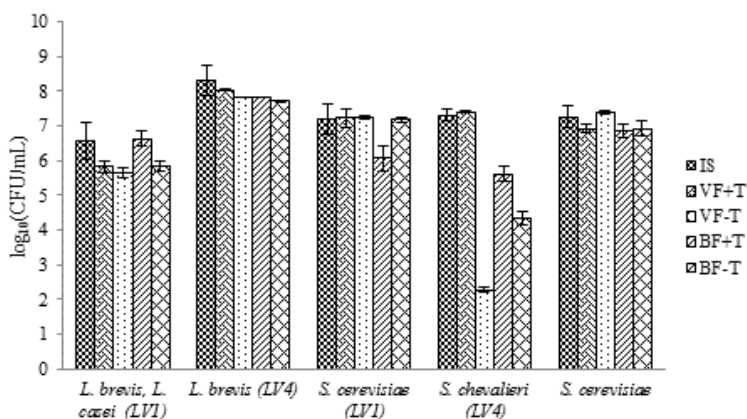

Figure 3. Effect of freezing process on commercial starter cultures and commercial baker's yeast viable cell count. *IS* – initial suspension; *VF+T* – vacuum freezing with trehalose addition; *VF-T* – vacuum freezing without trehalose addition; *BF+T* – blast freezing with trehalose addition; *BF-T* – blast freezing without trehalose addition

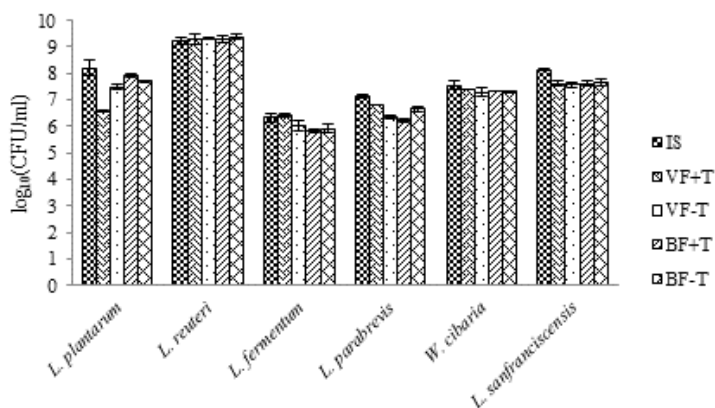

Figure 4. Effect of freezing process on single strain *LAB* culture viable cell count. *IS* – initial suspension; *VF+T* – vacuum freezing with trehalose addition; *VF-T* – vacuum freezing without trehalose addition; *BF+T* – blast freezing with trehalose addition; *BF-T* – blast freezing without trehalose addition.

In this research trehalose addition variously affected a survival rate of starter cultures submitted to freezing (Fig. 3 and 4). Trehalose addition positively affected survival of *S. chevalieri* (LV4) after both freezing conditions, *L. brevis* (LV4), *L. fermentum*, *L. parabrevis* after vacuum freezing, and *L. brevis*, *L. casei* (LV1), *L. plantarum* after blast freezing. Trehalose addition negatively affected survival of *S. cerevisiae*, *L. plantarum* after vacuum freezing, and *S. cerevisiae* (LV1), *L. parabrevis* after blast freezing. Trehalose addition had no effect on survival of *L. reuteri*, *W. cibaria*, *L. sanfranciscensis* after both freezing processes, *L. brevis*, *L. casei* (LV1), *S. cerevisiae* (LV1) after vacuum freezing, and *L. brevis* (LV4), *S. cerevisiae*, *L. fermentum* after blast freezing. Momose *et al.* (2010) and Hirasawa *et al.* (2001) reported positive effect of trehalose treatment on *S. cerevisiae* viability after freeze-thaw process. Before freezing, they incubated yeast cells in suspension with added trehalose which resulted in time dependent increase of intracellular trehalose content, and consequently increased viability after freeze-thaw process. Diniz-Mendes *et al.* (1999) reported that trehalose addition during freezing and freeze-drying process can improve yeast cells survival rate. Some researchers reported positive effect of trehalose addition on viability of different lactic acid bacteria strains (*Lactobacillus bulgaricus*, *Lactobacillus delbrueckii* subsp. *bulgaricus*, *Lactobacillus acidophilus*, *Streptococcus salivarius* subsp. *thermophilus*, and *Lactobacillus salivarius*) after freezing and freeze-drying process, while each strain showed a different sensitivity (De Antoni *et al.*, 1989; De Giulio *et al.*, 2005; Zayed and Roos, 2004). In contrast, Fonesca *et al.* (2003) did not find significant cryoprotective effect of trehalose addition to freezing media on *Lactobacillus delbrueckii* subsp. *bulgaricus* CFL1. Differences in applied trehalose concentration, freezing conditions and lactic acid bacteria strain included in the study may explain these discrepancies.

Considering presented results there are no overall optimal freezing conditions for all of the tested microorganisms. Even the presence of trehalose does not guarantee improved survival. The effect of different freezing conditions should be interpreted for each strain of LAB and yeasts separately. Comparing overall survival rate, *L. reuteri* showed the greatest resistance to freezing, with absolute survival after tested freezing conditions (Fig. 4). The strains *L. brevis*, *L. casei* (LV1), *S. cerevisiae* (LV1), *S. chevalieri* (LV4), *S. cerevisiae*, *L. fermentum* showed complete resistance for one of the tested freezing conditions. Only vacuum freezing of yeast strain *S. chevalieri* (LV4) without trehalose addition resulted in a considerable viable cell count reduction (5-log reduction). It was also the only case of significant positive influence of the trehalose – 100% survival after vacuum freezing with trehalose addition compared to 0.15% survival without trehalose addition (Fig. 3).

Other yeast and LAB strains did not show a significant decrease in the number of viable cells after freezing. Single strain cultures seem to be more suitable for freezing compared to commercial starter cultures microorganisms because of their lower survival variability depending on different freezing conditions. According to the results, the most appropriate bacterial strains for freezing conditions appear to be *L. reuteri* and *W. cibaria* considering survival rate greater than 50% for all applied freezing conditions and the lowest survival variability depending on the freezing conditions.

CONCLUSIONS

This study showed that the influence of vacuum and blast freezing microorganisms in the rye flour suspension with and without the addition of trehalose as cryoprotectants on *LAB* and yeasts is strain specific. Most of the examined *LAB* and yeast strains survived vacuum and blast freezing considering their viable cell count. Only vacuum freezing of yeast *S. chevalieri* (LV4) in suspension without trehalose substantially reduced the number of viable cells. In the same time, that was also the only case when trehalose addition had significantly positive effect on microbial survival rate. The most suitable strains for freezing applications seem to be *L. reuteri* and *W. cibaria* because of high survival rate and low survival variability depending on the freezing conditions. Presented results could be used as preliminary ones for examination of influence of freezing on microbial survival in real sample – sourdough environment

ACKNOWLEDGEMENTS

This work was supported by the Croatian Science Foundation (Research Project number 09.01/279, Vacuum cooling in prolonged shelf life food production).

REFERENCES

- Cheng, H.-P., Lin, C.-T. (2007): The morphological visualization of the water in vacuum cooling and freezing process, *J. Food Eng.* 78, 569-576. DOI:10.1016/j.jfoodeng.2005.10.025
- De Antoni, G.L., Pérez, P., Abraham, A., Añón, M.C. (1989): Trehalose, a cryoprotectant for *Lactobacillus bulgaricus*, *Cryobiology* 26, 149-153. DOI:10.1016/0011-2240(89)90045-X
- De Giulio, B., Orlando, P., Barba, G., Coppola, R., De Rosa, M., Sada, A., De Prisco, P.P., Nazzaro, F. (2005): Use of alginate and cryo-protective sugars to improve the viability of lactic acid bacteria after freezing and freeze-drying, *World J. Microb. Biot.* 21, 739-746. DOI 10.1007/s11274-004-4735-2
- De Vuyst, L., Neysens, P. (2005): The sourdough microflora: biodiversity and metabolic interactions, *Trends Food Sci. Tech.* 16, 43-56. DOI:10.1016/j.tifs.2004.02.012
- Diniz-Mendes, L., Bernardes, E., de Araujo, P.S., Panek, A.D., Paschoalin, V.M.F. (1999): Preservation of frozen yeast cells by trehalose, *Biotechnol. Bioengin.* 65,572-578. DOI: 10.1002/(SICI)1097-0290(19991205)65:53.3.CO;2-Z
- Dumont, F., Marechal, P.A., Gervais, P. (2003): Influence of cooling rate on *Saccharomyces cerevisiae* destruction during freezing: unexpected viability at ultra-rapid cooling rates, *Cryobiology* 46, 33-42. DOI:10.1016/S0011-2240(02)00161-X
- Fonseca, F., Beal, C., Corrieu, G. (2001): Operating Conditions That Affect the Resistance of Lactic Acid Bacteria to Freezing and Frozen Storage, *Cryobiology* 43, 189-198. DOI:10.1006/cryo.2001.2343
- Fonseca, F., Béal, C., Mihoub, F., Marin, M., Corrieu, G. (2003): Improvement of cryopreservation of *Lactobacillus delbrueckii* subsp. *bulgaricus* CFL1 with additives displaying different protective effects, *Int. Dairy J.* 13, 917-926. DOI:10.1016/S0958-6946(03)00119-5
- Fowler, A., Toner, M. (2005): Cryo-Injury and Biopreservation, *Ann. N. Y. Acad. Sci.* 1066, 119-135. DOI: 10.1196/annals.1363.010
- Gobbetti, M., De Angelis, M., Corsettic, A., Di Cagno, R. (2005): Biochemistry and physiology of sourdough lactic acid bacteria, *Trends Food Sci. Tech.* 16, 57-69. DOI:10.1016/j.tifs.2004.02.013

- Hirasawa, R., Yokoigawa, K., Isobe, Y., Kawai, H. (2001): Improving the freeze tolerance of bakers' yeast by loading with trehalose, *Biosci. Biotech. Bioch.* 65(3), 522-526. DOI: 10.1271/bbb.65.522
- Hubalek, Z. (2003): Protectants used in the cryopreservation of microorganisms, *Cryobiology* 46, 205-229. DOI:10.1016/S0011-2240(03)00046-4
- Kasper, J.C., Friess, W. (2011): The freezing step in lyophilization: Physicochemical fundamentals, freezing methods and consequences on process performance and quality attributes of biopharmaceuticals, *Eur. J. Pharm. Biopharm.* 78, 248-263. DOI:10.1016/j.ejpb.2011.03.010
- Kramer, M., Sennhenn, B., Lee, G. (2002): Freeze-drying using vacuum-induced surface freezing, *J. Pharm. Sci.* 91, 433-443. DOI: 10.1002/jps.10035
- Liu, J., Viverette, T., Virgin, M., Anderson, M., Dalal, P. (2005): A study of the impact of freezing on the lyophilization of a concentrated formulation with a high fill depth, *Pharm. Dev. Technol.* 10, 261-272. DOI: 10.1081/PDT-54452
- Momose, Y., Matsumoto, R., Maruyama, A., Yamaoka, M. (2010): Comparative analysis of transcriptional responses to the cryoprotectants, dimethyl sulfoxide and trehalose, which confer tolerance to freeze-thaw stress in *Saccharomyces cerevisiae*, *Cryobiology* 60, 245-261. DOI:10.1016/j.cryobiol.2010.01.001
- Nakamura, T., Takagi, H., Shima, J. (2009): Effects of ice-seeding temperature and intracellular trehalose contents on survival of frozen *Saccharomyces cerevisiae* cells, *Cryobiology* 58, 170-174. DOI:10.1016/j.cryobiol.2008.11.012
- Santivarangkna, C., Kulozik, U., Foerst, P. (2008): Inactivation mechanisms of lactic acid starter cultures preserved by drying processes, *J. Appl. Microb.* 105, 1-13. DOI:10.1111/j.1365-2672.2008.03744.x
- Zayed, G., Roos, Y.H. (2004): Influence of trehalose and moisture content on survival of *Lactobacillus salivarius* subjected to freeze-drying and storage, *Process Biochem.* 39, 1081-1086. DOI:10.1016/S0032-9592(03)00222-X

CHARACTERISTIC OF BARLEY SOURDOUGH DURING FROZEN STORAGE

UDC 664.66.03

Ivna Vrana Špoljarić, Nikola Maričić, Dubravka Novotni, Saša Ajredini,
Bojana Voučko, Duška Ćurić*

*University of Zagreb, Faculty of Food Technology and Biotechnology,
Pierottijeva 6, HR-10000 Zagreb, Croatia*

**Corresponding author: dnovotni2@pbf.hr*

ABSTRACT

The goal of this study was to determine the impact of freezing conditions and frozen storage time on barley sourdough properties. In this study barley sourdough was fermented by *Lactobacillus reuteri* or *Weissella cibaria* with or without sucrose addition. Sourdough was frozen with immersion or blast freezing and stored for four weeks at -18°C. Barley sourdough (20 % at dough basis) or native barley flour was mixed with semi-white wheat flour to determine its leavening ability by rheofermentometer at 30 °C for 3 h. Cell counts of sourdough bacteria were reduced by 1-2 log in both freezing processes and additionally during storage. In average, sourdough had total titrable acidity 15 mL of 0.1 N NaOH and pH 3.8 independently on starter, sugar addition, and freezing conditions. Farinograph consistency of composite bread doughs was 520 ± 20 BU at maximum and 480 ± 20 BU at the end of 8 min mixing. Development of composite bread dough with sourdough was in average 30 mm compared to 18 mm with native barley flour. Maximum height of developed composite dough was significantly ($p < 0.05$) improved by sucrose addition (+5 %) and diminished with storage time (-9 % in 4 weeks) of sourdough. Maximum height of gaseous production significantly decreased (-32 %) with sourdough storage during four weeks. The results indicate that barley sourdough fermented with either of the cultures could be frozen stored for four weeks and reactivated or directly used in bread making. Composite barley bread would be intended for consumers that want functional bakery products, since whole grain barley is a source of β -glucan that has ability to stimulate immune system and reduce the incidence of several chronic diseases.

Keywords: barley sourdough, leavening, rheofermentometer, acidity, frozen storage

INTRODUCTION

Barley is attracting consumers due to its β -glucans that are known to stimulate immune system, and prevent or reduce some pathologies, such as diverticular and heart disease, colon cancer, and type-2 diabetes (EFSA, 2011a, 2011b). Nonetheless, bread making potential of barley flour is weak compared to wheat flour resulting in low volume bread and dense crumb. For that reason, bread with acceptable quality can be made by substituting up to 20 % wheat flour with barley flour and its fibre-rich fractions (Izydorczyk *et al.*, 2008, Baik and Ullrich, 2008; Sullivan *et al.*, 2013).

Sourdough is traditionally used for dough leavening, particularly in whole grain bakery products since it can improve bread volume, texture, flavour, shelf-life and nutritive value (Arendt *et al.*, 2007; Gobbetti *et al.*, 2014). Several studies characterized barley sourdough from a microbiological and technological point of view and for bread making (Mariotti *et al.*, 2014; Marklinder *et al.*, 1996; Rieder *et al.*, 2012; Zannini *et al.*, 2009). In sourdough, *Lactobacillus* strains are more frequently found than *Weissella* species. Recently, *Weissella cibaria* has been explored for sorghum sourdough (Galle *et al.*, 2012) and barley-malt-derived wort fermentation (Zannini *et al.*, 2013).

Microbial cultures that dominate in sourdough need to be kept metabolically active by back-sloping (Lattanzi *et al.*, 2014), i.e. daily addition of flour and water to sourdough, followed by fermentation. However, microbial ecosystem can be easily perturbed due to environmental contamination and use of different batches of flour during time. Disturbance of microbial stability may reflect in the change of both the technology performance of sourdough and the overall quality of the baked product (Minervini *et al.*, 2014). Preservation of sourdough by daily back-sloping is technologically non-demanding, but it is tiring and time consuming procedure when sourdough needs to be prepared from the start. For that reason, bakers sometimes store sourdough in the refrigerator, or use dried one. Lattanzi *et al.* (2014) assessed the influence of refrigerated, frozen and dried storage on technological performances and bacterial diversity of wheat type-I sourdoughs periodically reactivated. They showed that sourdough lactic acid bacteria can be partially preserved by frozen storage up to 90 days and that bread obtained from reactivated frozen sourdough has similar quality features as bread from nonstored sourdough.

In this study, we investigated the influence of blast and immersion freezing and storage time on characteristics of barley sourdough fermented with *Lactobacillus reuteri* or *Weissella cibaria* with or without sucrose addition. Composite bread dough containing 20 % (at dough basis) of fresh or frozen stored barley sourdough was tested for its leavening ability at rheofermentometer.

MATERIALS AND METHODS

Raw materials

Semi-white wheat flour (T-850) containing 11.95 % of moisture, 11.12 % of proteins, 1.31 % of fats, 0.67 % of ash, 0.47 % of sugars, and having rheological characteristics shown in Table 1, was provided by Papuk Inc. (Našice, Croatia). Wholegrain barley flour (Advent, Pula, Croatia) contained 11.24 % of moisture, 11.26 % of proteins, 1.53 % of fats, 1.15 % of ash, 0.42% of sugars, and had low amylolytic activity (amylograph maximum viscosity 1730 AJ).

Table 1. Rheological properties of semi-white wheat flour (T-850)

Farinograph	Water absorption		59 %
	Stability		0 min
	Resistance		2 min
	Softening degree		95 FJ
	Quality number		57.5
Proving time (min)			
Extensograph	Energy		558.5 cm ²
	Extensibility		163.0 mm
	Resistance to extension	45	187.5 EJ
	Extension/extensibility		1.1
	Energy		657.0 cm ²
	Extensibility		158.5 mm
	Resistance to extension	90	245.0 EJ
	Extension/extensibility		1.5
	Energy		649.0 cm ²
	Extensibility		160.0 mm
	Resistance to extension	135	237.5 EJ
	Extension/extensibility		1.5
Amylograph	Maximum viscosity		1415 AJ

Starter cultures

Barley sourdough (DY=250) was fermented by *Weissela cibaria* (DSM 15878), with or without sucrose addition (10 % at flour basis), or *Lactobacillus reuteri* (DSM 20016), with or without sucrose (10 % at flour basis). Microbiology cultures were propagated in MRS broth (Biolife, Italy) for total 96 hours, and then were centrifuged (10 min, 3000 rpm). Residue was washed with sterile tap water twice and biomass was re-suspended in 100 ml of sterile tap water for a cell density of 10¹⁰ – 10¹¹ CFU/ml.

Sourdough fermentation and freezing

Barley sourdough was inoculated with fresh culture in order to obtain 10⁸ CFU/g sourdough. Flour with water and starter culture was mixed for 5 min. Sourdough with *W. cibaria* was fermented at 30 °C for 24 h and with *L. reuteri* at 37 °C for 24 h. During the fermentation, pH value was monitored and recorded with data logger (Omega Engineering, USA). Colony forming units (CFU) in sourdough were determined on MRS plates (Biolife, Italy) after 48 h of anaerobic incubation at 30 and 37 °C for *W. cibaria* and *L. reuteri*, respectively.

Barley sourdoughs were frozen either in a blast freezer (ABF 05, Everlasting, Italy) or by immersion in thermostatic bath with glycol : water (1:2) (Huber CC515, Peter Huber, Germany), both set at -30 °C. Frozen samples were kept in deep freeze on -18 °C for 2 or 4 weeks. Before analyses, sourdough was thawed in a refrigerator at 4 °C for 24 hours.

Sourdough pH value after thawing was measured using pH meter (3510 pH meter, Jenway). CFU/g of sourdough was determined as described above. The total titratable acidity (TTA) was determined on 10 g of sourdough suspended in 90 ml of water by titration with 0.1N NaOH until pH 8.5±0.1.

Bread dough preparation and rheofermentograph testing

Bread dough with sourdough was prepared from semi-white wheat flour (193 g), water (80 ml), compressed bakers' yeast (7 g) (Kvasac Ltd., Croatia) and sourdough (70 g), fresh or after frozen storage. The control bread dough without sourdough was made of semi-white wheat flour (193 g), native barley flour (28 g), water (122 mL) and compressed yeast (7 g). Mixing was performed in Brabender farinograph at speed 2 for 8 min at 30 °C. Parameters related to dough development, gas production, and gas retention were measured by rheofermentometer F3 (Chopin, France) in duplicate. The dough (315 g) was tested under 2 kg weight constraint at 30 °C for 3 h. Measured rheofermentometer parameters included: maximum dough height (Hm), time of Hm (T1); maximum height of gaseous production (H'm), time of maximum gas formation (T'1), total CO₂ volume production, volume of the gas retained in the dough at the end of the test (CO₂ retention). Each experiment was carried out in duplicate.

Statistical analysis

Factorial analysis of variance (ANOVA) was performed to indicate the effect of starter, sucrose addition, freezing method and storage time of sourdough on bread dough leavening ability by using Statistica 8.0 (Stat Soft Inc., USA).

RESULTS AND DISCUSSION

Sourdough characteristics

In 24 hours of barley sourdough fermentation, pH value dropped for 2 points and at the end was in average 3.8 (Figure 1). Sourdough acidification kinetics was not affected by starter culture or sucrose addition.

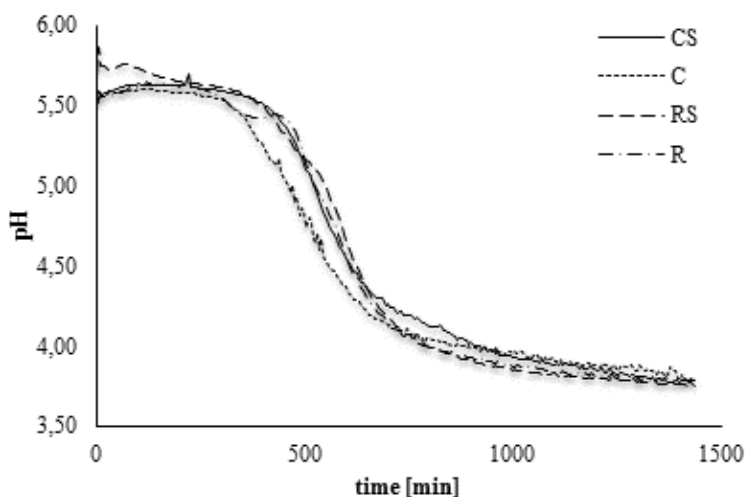

Figure 1. Acidification rate of sourdough started with *W. cibaria* without (C) or with sucrose (CS) and *L. reuteri* without (R) or with sucrose (RS) addition

Figure 2 presents protocols for sourdough freezing. Independently on starter culture and sucrose addition, blast freezing was quicker than immersion method. Average rate to reach -18°C for sourdough in blast freezer was 46.5°C/h and in it was immersion 19.3°C/h . Thus, time needed that a portion of sourdough achieves the final temperature of -18°C was 2.4 fold shorter in blast freezer than for immersion freezing.

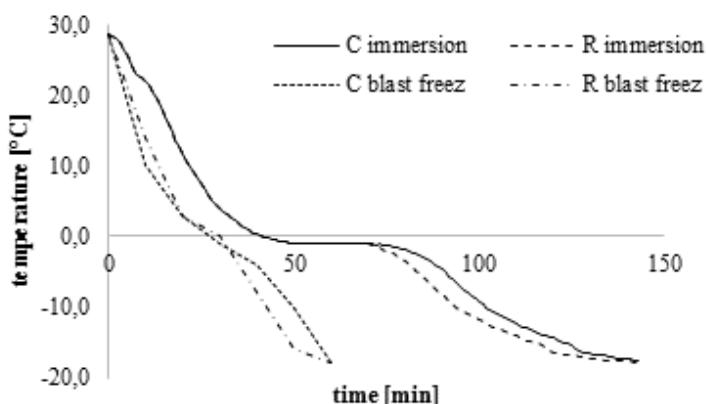

Figure 2. Comparison of blast and immersion freezing process for barley sourdough fermented by *W. cibaria* (C) or *L. reuteri* (R), with or without sucrose addition

Table 2. Colony forming units (log CFU/g) in nonfrozen sourdough compared to sourdough blast or immersion frozen during 28 days of storage depending on starter and sucrose addition (*W. cibaria* with (CS) or without (C) sucrose and *L. reuteri* with (RC) or without (R) sucrose)

Storage (days)		log CFU/g			
		CS	C	RS	R
0	Nonfrozen	9.06	10.56	9.23	9.28
14	Immersion	8.23	8.74	8.05	8.22
14	Blast freezer	8.82	8.24	8.97	8.05
28	Immersion	7.43	7.62	8.35	7.72
28	Blast freezer	6.36	6.93	7.74	8.18

CFU after sourdough fermentation before freezing was typical for sourdough. Our results are in agreement with data by Mariotti *et al.* (2014) for barley sourdough. Sourdough freezing process (whether immersion or blast) and 14 days of frozen storage has decreased the CFU value by one log. Further reduction by one more log was observed after 28 days of sourdough frozen storage, except in sourdough with *L. reuteri* that was blast frozen. Nevertheless, recent research by Lattanzi *et al.* (2014) demonstrated the possibility of a partial reactivation of the lactic acid bacteria from frozen sourdough even after 90 days of storage having the ability to acidify dough in a comparable way to the unstored sourdough. Freezing enables the long-term preservation of living cells. However, lactic acid bacteria (LAB) cells can be damaged by the cryopreservation process itself. The physical events in the cells depend on the freezing rate that affects the size of ice crystals and localisation of crystallization centres (Mazur, 1984). In our study, both freezing methods were rather slow and no significant difference was observed between blast and immersion freezing on CFU of chosen starter cultures.

Fermentation of barley flour with *L. reuteri* and *W. cibaria* resulted with pH and TTA values that are typical of barley sourdough (Table 3). Mariotti *et al.* (2014) determined a similar pH value of barley sourdough (3.8) but in the same time higher TTA than we did (19.5). The reason for this difference could be that they used mixed starter of lactic acid bacteria and yeast. Generally, acidity of sourdough depends on the application of starter culture, ash content of flour, amount of fermentable sugars in the dough, and the activity of endogenous α -amylase (Hansen and Hansen, 1994).

In average, our barley sourdough fermented with *L. reuteri* showed a higher acidity than those fermented with *W. cibaria*. Contrary, Galle *et al.* (2012) showed that sorghum sourdough had higher pH value and lower TTA when fermented with *W. cibaria* than with *L. reuteri*. These differences may occur because Galle *et al.* (2012) for sourdough preparation used sorghum flour in dough yield 200 while we used barley flour in dough yield 250.

Table 3. pH value and TTA in sourdough nonfrozen and blast or immersion frozen and stored for 28 days depending on starter culture and sucrose addition (*W. cibaria* with (CS) or without (C) sucrose, and *L. reuteri* with (RS) or without (R) sucrose)

Storage (days)		pH				TTA [ml 0,1 M NaOH]			
		CS	C	RS	R	CS	C	RS	R
0	Nonfrozen	3.77	3.73	3.96	3.96	14.69	14.32	17.46	15.6
14	Immersion	3.84	3.85	3.86	3.86	16.9	14.94	17.18	15.22
14	Blast freezer	3.81	3.81	3.93	3.89	17.2	15.23	17.37	15.33
28	Immersion	3.52	3.77	3.65	3.66	15.62	14.3	17.26	15.26
28	Blast freezer	3.59	3.55	3.67	3.65	14.9	14.54	17.02	14.64

Sucrose addition affected positively total acidity of sourdough. In average, TTA value of *L. reuteri* sourdough with sucrose was 17.3 compared to 15.9 without sucrose addition. The sucrose effect in *W. cibaria* sourdough was smaller but still visible, causing the increase of TTA from average 14.7 to 15.9. Similarly, Galle *et al.* (2012) obtained higher acidity of sorghum sourdough fermented with *L. reuteri* after adding sucrose (15 %); however they did not observe this effect after adding sucrose to *W. cibaria* sorghum sourdough.

After 14 days of frozen storage, sourdoughs with *W. cibaria* showed slight increase in TTA values compared to the nonfrozen sourdough. These results suggest that acidification activity of *W. cibaria* was preserved for 14 days at -18 °C. After 28 days of frozen storage, pH value of sourdoughs was somewhat lower than for nonfrozen samples, which indicates solvation activity of hydrogen ions.

Dough development and gaseous release in composite bread doughs with added sourdough

Information about the development of the composite wheat dough with added barley sourdough and its ability to produce and retain gas was continuously monitored by rheofermentometer. Since dough consistency affects the rate of proofing, it was monitored during mixing in the farinographic bowl. Composite dough maximum consistency was in average 520 ± 20 FJ, while the consistency at the end of 8 min mixing was in average 480 ± 20 FJ. Consistency of bread dough did not differ among samples and did not depend on starter culture, sucrose addition, storage time and freezing method of added sourdough ($p > 0.05$).

Sourdough has traditionally been used as a leavening agent in bread making, but in most industrial applications, sourdough is added to bread doughs which also contain baker's yeast as a leavening agent. In this study, rheofermentometric measurements of composite bread dough development and gaseous release were conducted with bakers' yeast (2 % on flour basis). When bread dough was prepared with sourdough addition but without bakers' yeast, no increase of total volume of dough was detected (data not shown). The

control dough contained equal amount of barley flour and bakers' yeast but lactic acid bacteria were not added.

In comparison to control, bread doughs with added sourdough exhibited pronouncedly greater maximum height. Further, the control dough that showed in average 71 % lower maximum height compared with dough prepared with nonfrozen sourdough, needed 10.5% longer time to achieve that maximum height. Greater dough maximum height in rheofermentometer indicates that the microstructure of the dough in combination with the produced gas is better compared to other systems with lower height. Bread dough with the addition of sourdough fermented with *L. reuteri* had a slightly higher maximum height (in average 30.1 mm), than those with the addition of *W. cibaria* sourdough (in average 29 mm) (Table 4) but this was not statistically significant ($p>0.05$). Contrary to our results, Palacios *et al.* (2008) showed that presence of *L. reuteri* induced a pronounced decrease in the maximum dough height of whole wheat dough but resulting breads in the presence of the selected lactobacilli had similar technological quality as the control without lactobacilli. However, in their study sourdough fermentation was omitted and *L. reuteri* was added directly for rheofermentometric measurement. In our study, sucrose addition for sourdough fermentation had made small but positive impact on the maximum height of composite dough ($p=0.04$), which was in average by 3.5 % higher compare to when sucrose was not added. Nevertheless, doughs with sucrose sourdoughs needed longer time to achieve these bigger heights (11.3% in average). We believe that sucrose presence in sourdough favoured exopolysaccharides (EPS) production by *W. cibaria* and *L. reuteri* which are known supporters for keeping the gas in bread dough. Exopolysaccharides (glucans and levan) produced by *L. reuteri* and *W. cibaria* improve dough stability and gas retention through a structure build up and interactions with the gluten network (Tieking and Ganzle, 2005). In comparative studies by Galle *et al.* (2012) and Tieking and Gänzle (2005), it was found that dextran forming *W. cibaria* had a greater effect on viscoelastic properties of wheat doughs and on the volume of breads compared to the same level of fructan or reuteran produced by *L. reuteri*. In our study, the average maximum dough height with *L. reuteri* sourdough was slightly higher (by 4 %, $p=0.07$) than with *W. cibaria* sourdough. This could be strain specific, but also we used barley and not wheat flour for sourdough fermentation unlike the previous studies. *In situ* EPS production has the advantage to enhance dough and bread properties but also may exert human health benefits based on improved bowel functions, prevention of overgrowth of pathogenic bacteria, through the stimulation of probiotic members of the intestinal microbiota, and increased synthesis of short-chain fatty acids (Ketabi *et al.*, 2011).

The freezing method did not significantly affect the maximum height of bread dough. Nonetheless, the maximum height of bread dough during leavening decreased significantly ($p=0.03$) as sourdough fermented without sucrose was longer frozen stored. After 28 days of frozen storage, the maximum height of bread doughs sourdoughs started *W. cibaria* or *L. reuteri* without sucrose was lower by 13 % and 18 %, respectively, compared to bread doughs with nonfrozen sourdoughs. It is known that sucrose induces EPS synthesis by *W. cibaria* or *L. reuteri* and these EPS improve dough stability during frozen storage (Tieking and Gänzle, 2005). Therefore, both LAB starters could be used for barley

sourdough fermentation but sucrose addition is recommended for frozen sourdough since it has improved stability and fermentation performance.

Table 4. Maximum dough height (Hm) and development time (T) of control bread dough (Ctrl) and with sourdough addition (*W. cibaria* with sucrose (CS) or without sucrose (C) and *L. reuteri* with sucrose (RC) and without sucrose (R)) depending on freezing method and storage time

Storage (days)		Maximum dough height (mm)					Maximum development time (min)				
		Ctrl	CS	C	RS	R	Ctrl	CS	C	RS	R
0	Nonfrozen	18.2	29.6	31.3	31.7	32.2	92	89	67	89	85
14	Immersion		30.7	25.6	30.6	30.4		103	77	95	92
14	Blast		29.2	31.3	32.0	29.8		60	77	66	95
28	Immersion		28.2	27.4	30.7	28.1		111	85	100	61
28	Blast		29.8	27.3	29.4	26.3		94	88	84	70

Besides sucrose addition, maximum development time for dough with added frozen sourdough was significantly influenced by freezing method (favouring blast frozen sourdough), but more importantly interactions of starter and frozen storage time, sucrose addition and freezing method, sugar addition and storage time as well as starter, sugar addition and storage time (Table 6).

Maximum dough height is mostly determined by the amount of CO₂ generated through the fermentation activity of present yeast. The concentration of yeast cells is the most important parameter that determines the amount of gas produced, but the presence of lactic acid bacteria might affect the yeast during the CO₂ production (Gobbetti, 1998). The maximum height of gaseous release of bread dough decreased as the storage time of added sourdough was longer (average decrease 15 % after 14 days and 32 % after 28 days) (Table 5).

Sourdough starter, sucrose addition and the freezing method did not significantly affect maximum height of gaseous release. The control bread dough without sourdough showed in average 3 % lower maximum height of gaseous release compared to dough with nonfrozen sourdough. Generally, the contribution of LAB and yeast to CO₂ production in sourdough breads differs with the type of starter culture and the dough technology applied (Hammes & Gänzle, 1998).

Table 5. Gas production and retention generated during the fermentation of bread dough without sourdough addition (Ctrl) and with sourdough addition (*W. cibaria* with sucrose (CS) or without (C) sucrose and *L. reuteri* with sucrose (RC) and without (R) sucrose) depending on freezing method and storage time

Storage (days)	Freezing	Maximum gaseous production height (mm)					Maximum gas formation time (min)					CO ₂ retention volume (ml)				
		Ctrl	CS	C	RS	R	Ctrl	CS	C	RS	R	Ctrl	CS	C	RS	R
0	None	85.5	87.1	92.9	87.3	85.2	35	50	27	50	40	1435	1361	1119	1275	1179
14	Immersion		81.4	70.1	62.8	70.9		50	42	53	40		1227	982	926	1054
	Blast		80.6	74.4	86.6	74.0		42	38	46	38		1102	944	1153	1145
28	Immersion		60.7	67.3	69.8	70.3		53	35	46	62		1170	1092	1202	1073
	Blast		56.1	68.5	48.9	40.8		53	36	48	62		1075	1147	945	758

The time to reach maximum gaseous height indicates ability of dough expansion during baking, which usually positively correlates with a higher volume of bread and softer bread crust texture. Sucrose addition during sourdough fermentation had a significant impact on the time of maximum gas formation (Table 6), as its addition prolonged the time for reaching maximum gaseous height. This scientific work was supported by the Croatian Science Foundation project VH/VT Hrana (Vacuum cooling in prolonged shelf life food production; project number 09.01/279). Time to reach maximum gaseous height (from 39 min to 49 min, in average). Sourdough starter, freezing method and storage time did not have significant effect on the time to reach the maximum gaseous height. The control bread dough without sourdough needed 18.6 % shorter time to reach the maximum gaseous height in comparison with average dough prepared with nonfrozen sourdough.

Table 6. Significant *p*-values (≤ 0.05) of ANOVA for rheofermentometer parameters of bread dough with added frozen sourdough

	Hm	T1	H'm	T'1
Freezing type (blast, immersion)		0.002		
Storage time (14-28 d)	0.038		0.058	
Sucrose add (Yes/No)	0.016	0.015		0.022
Starter×Storage time		0.001		
Freezing type×Sugar add		<0.001		
Storage time×Sugar add		0.001		
Starter×Storage time×Sugar add		0.031		

Sourdough starter, sucrose addition, freezing method and storage time did not significantly affect volume of CO₂ retained in bread dough. The control bread dough without sourdough in average showed 8 % higher total CO₂ retention volume compared with dough prepared with nonfrozen sourdough. The total CO₂ retained volume showed a positive correlation with the total CO₂ volume produced during dough fermentation (data not shown). Therefore, we can assume that the concentration of yeast cells was the main factor that determined CO₂ production and retention in our bread doughs. The total CO₂ retained volume is considered to be important for the structure of the crust of bread and its volume (Giannou *et al.*, 2003).

CONCLUSION

Starter cultures *W. cibaria* and *L. reuteri* have proven as appropriate starters for barley sourdough fermentation. Addition of barley sourdough at 20 % independently on starter culture contributed to the improved leavening ability of composite bread dough. Bread dough with added sourdough had significantly higher maximum dough height and needed shorter time to reach it compared to control dough without sourdough. Sucrose addition during sourdough fermentation had a positive effect on maximum dough height during leavening. Blast freezing of sourdough is quicker and thus favored over immersion process. Freezing and frozen storage of barley sourdough negatively affected viability of starter cultures, and respectively maximum height and gaseous release of bread dough during leavening. Still, barley sourdough frozen stored for up to 4 weeks, after thawing and refreshment or even directly but with addition of baker's yeast for leavening could be used for making bread that is a source of prebiotic fibre.

ACKNOWLEDGEMENTS

This work has been supported in part by Croatian Science Foundation under the project 1321.

REFERENCES

- Arendt, E.K., Ryan, L.A.M., Dal Bello, F. (2007): Impact of sourdough on the texture of bread, *Food Microbiol.* 24, 165-174.
- Baik, B.K., Ullrich, S.E. (2008): Barley for food: characteristics, improvement, and renewed interest, *J. Cereal Sci.* 48, 233-242.
- EFSA (2011a) Scientific Opinion on the substantiation of health claims related to beta-glucans from oats and barley and maintenance of normal blood LDL-cholesterol concentrations (ID 1236, 1299), increase in satiety leading to a reduction in energy intake (ID 851, 852), reduction of post-prandial glycaemic responses (ID 821, 824), and "digestive function" (ID 850) pursuant to Article 13(1) of Regulation (EC) No 1924/2006. *EFSA Journal*, 9(6):2207. <www.efsa.europa.eu/efsajournal.
- EFSA (2011b) Scientific Opinion on the substantiation of a health claim related to barley beta-glucans and lowering of blood cholesterol and reduced risk of (coronary) heart disease pursuant to

Article 14 of Regulation (EC) No 1924/2006. EFSA Journal, 9(12):2471.

<www.efsa.europa.eu/efsajournal>

Galle, S., Schwab, C., Dal Bello, F., Coffey, A., Ganzle, M., Arendt, E. (2012): Influence of in-situ synthesized exopolysaccharides on the quality of gluten free sorghum bread, *Int. J. Syst. Evol. Micr.* 155, 105-112.

Giannou, V., Kessoglou, V., Tzia, C. (2003): Quality and safety characteristics of bread made from frozen dough. *Trends, Food. Sci. Tech.* 14, 99-108.

Gobbetti, M., Rizzello, C. G., Di Cagno, R., De Angelis, M. (2014): How the sourdough may affect the functional features of leavened baked goods, *Food Microbiol.* 37, 30-40.

Gobbetti, M., Rizzello, C.G., Di Cagno, R., De Angelis, M. (2014): How the sourdough may affect the functional features of leavened baked goods, *Food Microbiol.* 37, 30-40.

Hansen, A., Hansen, B. (1994) Influence of wheat flour type on the production of flavour compounds in wheat sourdoughs, *J. Cereal Sci.* 19, 185-190.

Izydorczyk, M.S., Chornick, T.L., Paulley, F.G., Edwards, N.M., Dexter, J.E. (2008): Physicochemical properties of hull-less barley fibre-rich fractions varying in particle size and their potential as functional ingredients in two-layer flat bread, *Food Chem.* 108, 561-570.

Ketabi, A., Dieleman, L. A., Gänzle, M. G. (2011): Influence of isomalto-oligosaccharides on intestinal microbiota in rats, *J. Appl. Microbiol.* 110, 1297-1306.

Lattanzi, A., Minervini, F., Gobbetti, M. (2014): Assessment of comparative methods for storing type-I wheat sourdough, *LWT-Food Sci. Technol.* 59, 948-955.

Mariotti, M., Garofalo, C., Aquilanti, L., Osimani A., Fongaro, L., Tavoletti S., Hager, A.S., Clementi, F. (2014): Barley flour exploitation in sourdough bread-making: a technological, nutritional and sensory evaluation, *LWT - Food Sci. Technol.* 59, (2), 973-980.

Marklinder, I., Haglund, A., Johansson, L. (1996): Influences of lactic acid bacteria on technological, nutritional, and sensory properties of barley sour dough bread, *Food Qual. Pref.*, 7, 285-292.

Mazur, P. (1984): Freezing of living cells: mechanisms and implications, *Am. Physiol. Soc.* 125-143.

Minervini, F., De Angelis, M., Di Cagno, R., Gobbetti, M. (2014): Ecological parameters influencing microbial diversity and stability of traditional sourdough, *Int. J. Food Microbiol.* 171, 136-146.

Palacios, M. C., Haros, M., Sanz, Y., Rosell, C. M. (2008): Selection of lactic acid bacteria with high phytate degrading activity for application in whole wheat breadmaking, *LWT-Food Sci. Technol.* 41, 82-92.

Rieder, A., Holtekjølen, A.K., Sahlstrøm, S., Moldestad, A. (2012): Effect of barley and oat flour types and sourdoughs on dough rheology and bread quality of composite wheat bread, *J. Cereal Sci.* 55, 44-52.

Sullivan, P., Arendt, E., Gallagher, E. (2013): The increasing use of barley and barley by-products in the production of healthier baked goods. *Trends Food Sci. Tech.* 29, 124-134.

Tieking, M., Gänzle, M. G. (2005): Exopolysaccharides from cereal associated lactobacilli, *Trends Food Sci. Technol.* 16, 79-84.

Zannini E., Mauch, A., Galle S., Ganzle M., Coffey A., Arendt E.K., Taylor J.P., Waters D.M. (2013): Barley malt wort fermentation by exopolysaccharide forming *Weissella cibaria* MG1 for the production of a novel beverage, *J. Appl. Microbiol.* 115, 1379-1387.

Zannini, E., Garofalo, C., Aquilanti, L., Santarelli, S., Silvestri, G., Clementi, F. (2009): Microbiological and technological characterization of sourdoughs destined for bread-making with barley flour, *Food Microbiol.* 26, 744-753.

POSSIBILITIES OF USING ACORN FLOUR IN PRODUCTS BASED ON FLOUR

UDC

Mirjana Polimac^{1*}, *Daliborka Koceva Komlenić*², *Jasmina Lukinac*²

¹*Ivana Gorana Kovačića 6, HR- 31000 Osijek, Croatia*

**Corresponding author: mpolimac@lycos.com*

²*Josip Juraj Strossmayer University of Osijek, Faculty of Food Technology Osijek,
Franje Kuhača 20, HR-31000 Osijek, Croatia*

ABSTRACT

Oaks (*Quercus* spp.) are widespread species of temperate zone of the northern hemisphere including Europe, North Africa, Middle East, Asia and North America. Acorns, the fruit of the oak, have been used in human nutrition for thousands of years and more recently archaeological research confirms that in the past acorns have been important sources of food in different cultures around the world. Today it is used as food in Turkey, Korea, North Africa, China, the USA and as an important part of cultural heritage in some parts of Spain.

Acorn was staple food in the diet of the Balkan peoples, but despite its long culinary tradition acorn has been neglected. The sad fact is that we have forgotten all about nutritional value of acorns that our ancestors knew and used.

The aim of this study is a qualitative analysis of the existing literature concerning the investigation of food products from acorns, primarily the possibility of using acorn flour in products based on flour. Based on citation bases Web of Science and Scopus 42 articles have been selected that included the period from 1977 to 2015. Most of the studies were published by authors from the United States (14), Italy (6) and China (5). Additional searches were done by using Google Web Search. Regarding these results acorn flour can be used in modern diet as a replacement for wheat flour in wide range of applications in food production, primarily production of cakes, cookies, muffins, pancakes, pasta, noodles, flatbreads, pizza crust, pie crust, and also for thickening sauces and soups.

However, analysis of the literature reveals a lack of research in Croatia, and generally points out the need for greater representation of these issues in the future.

Keywords: oak; acorn; food; acorn flour; products based on flour

INTRODUCTION

Oak (*Quercus*) is a significant and rich genus of the *Fagaceae* family, containing 300-500 species of trees and shrubs (Nixon 1993; Trinajstić 2007). It is widely distributed species of temperate zone of the northern hemisphere, including Europe, North Africa, Middle East, Asia and North America, which reaches a height of up to 50 m, a diameter up to 2.5 m, and the age up to 1500 years. There are 12 oak species registered in Croatia (Trinajstić 2007). Well known fruit of the oak is acorn. Acorns of pedunculate oak (*Quercus robur* L.) are elongated oval, light brown or yellowish in color, with longitudinal darker stripes. Acorn's „cap" called cupula by experts is covered with tiny, taped shells, ripen in September and October. Due to the large share of alkaloids, acorns are bitter and astringent, but in the past they were used as food, especially in times of famine.

There is a strong link between human civilization and the oak, at least 30 000 years ago in Europe and Asia, as well as 14 000 years in North America. The oaks have been an important source of building materials and food supplies for people since prehistoric times, and still are, significant renewable resource of many modern economies.

As the world faces increasing challenges from climate change, consumption of natural resources, biodiversity loss, poverty and population growth, it is increasingly clear that it is necessary to find and switch to new forms of sustainable production and consumption. Accordingly, the demand among consumers for healthier and natural products, resulting from environmentally friendly production, shows a growing trend globally.

In this literature review, we want to give a picture of what the use of acorn is, with special reference to flour and flour-based products in different parts of the world, in the past and the beginning of this century.

MATERIALS AND METHODS

In February 2015 started an online search of the following citation databases:

1. Web of Science, published by ISI-Thomson Reuters - the oldest citation database of magazines classified according to three thematic citation indexes: SCI (Science Citation Index) natural, technical and biomedical sciences; SSCI (Social Science Citation Index) Social Sciences; A & HCI (Art and Humanities Citation Index) Humanities and Arts
2. Scopus - recent citation database, which includes a large number of Croatian magazine.
3. Google web search - Google's Internet search engine owned by Google Inc.

As a keyword in the search were used the name of the genus (*Quercus*) and the name of its fruits-acorns, and subsequent results were defined as articles relating to human consumption of acorn or acorn flour. A total of 42 separate articles were published in the period from 1977 - 2015.

Further analysis of articles was done according to the subject of this article, the author, scientific area, chronological distribution and geographical location.

RESULTS AND DISCUSSION

Summary of the literature pertaining to the possibilities of using acorn flour in products based on flour.

Citation databases

Table 1. A literature review on the use of meal of acorns (citation database)

Subject:	%	Author and year:
Historical data about the acorn consumption and technologies related to the processing of acorns for human consumption	69 %	(Revedin <i>et al.</i> 2015),(Stevens & McElreath 2015), (Morales <i>et al.</i> 2015), (Antolín & Jacomet 2015), (Valamoti 2015), (Yang <i>et al.</i> 2014), (Tushingam & Bettinger 2013), (Saul <i>et al.</i> 2012), (Morgan 2012), (Regnell 2012), (Liu <i>et al.</i> 2011), (Fuller & Qin 2010),(Yang & Jiang 2010), (Borojević <i>et al.</i> 2008)(Pringle 2008), (Fuller <i>et al.</i> 2007), (Sadori & Susanna 2005), (Lev <i>et al.</i> 2005), (McCreary 2004), (Gremillion 2002), (Mason 2000), (Bouby <i>et al.</i> 1999), (Kubiak-Martens 1999), (Ivanhoe & Chu 1996), (Ivanhoe 1995), (Regnell <i>et al.</i> 1995), (McCorrison 1994), (Schneider 1990), (Jorgensen 1977)
The content of tannin in the acorn	31 %	(Luczaj <i>et al.</i> 2014)
Acorn Bread		(Claudia 2013)
Acorn Starch		(Cappai <i>et al.</i> 2013), (Correia & Beirão-Da-Costa 2010), (Yang & Jiang 2010), (Choi & Jun 2008)
Acorn Cake		(Pignone & Laghetti 2010)
Nutritional and antioxidant value of acorns (properties of polysaccharides, phenolic compounds) functional properties of polysaccharides isolated from acorns		(Tadayoni <i>et al.</i> 2015), (Benmahdi-Belarbi <i>et al.</i> 2007), (Rakić <i>et al.</i> 2007), (Rakić <i>et al.</i> 2006)
Allergy to acorns		(Roux <i>et al.</i> 2003)
Anti-inflammatory properties of acorns (anti-asthma effect)		(Moon <i>et al.</i> 2013)

Table 1 shows the results of researching scientific papers, dealing with acorn flour as a food source. The greatest number of scientific articles (69 %) refined on archaeological research, which recorded that the acorn was used as food for thousands of years, virtually wherever there were oak trees. Only a small number of authors (31 %) explore the possibility of using the nutritional value of acorns, as well as food products that have been at the disposal from the distant prehistoric times until today.

Acorns of various oak species, used as the main food products distributed around the world from prehistoric times until today, has been documented in a number of articles. Acorn is a traditional food of many indigenous tribes of North America, but a particularly important role was played by the tribes in California that are using acorn in their diet with as many as 20 species of oaks (Schneider 1990). North American Indians are generally very dependent on this source of food, which are collected and processed (McCreary 2004; McCorriston 1994; Pringle 2008; Ivanhoe & Chu, 1996; Ivanhoe 1995, Gremillion 2002, Stevens & McElreath 2015). Acorns were gathered and processed for consumption mainly by women. Processing, in three main phases was used to remove the bitter tannins and it included the cleaning of acorns from the outer shell, crushing with pestle in a mortar, then rinse obtained acorn flour repeatedly pouring water in the sand pool, which was sometimes lined with grass or in open baskets coated with sand. After rinsing, the flour was cooked in baskets, stone bowls or containers made of wood or bark, with the hot stones, and consumed as porridge or soup. Bread is also made from acorn flour, baked on a stone or coal, in a clay oven or ashes. Less intensive processing methods (e.g. passive flushing water over the acorns, before chipping and grinding) were common in some areas of Northern California, but these techniques have played a minor role compared to intensive methods described previously (Tushingham & Bettinger 2013; D. Prichep 2014). Analysis of different storage techniques during the Holocene period in California showed that the hunters - gatherers stored food. Ethnographers describe the technology for storage of acorns, which were used by the California Mono tribe. Mono guarded collected acorns in their camps and villages in covered barns, built on platforms mounted on wooden poles, or on the ground. They also built stone barns, composed of laying big and small stone pieces. They are found almost exclusively on large granite plateaus of southern exposure that favors the drying of acorns (Morgan 2012).

The second region of importance is Asia. Exploring the use of plant hunter - gatherers in the late Paleolithic in China revealed the remains of starch on the analyzed artifacts and show that the former residents gathered and grind into flour, including oak acorns (Liu *et al.*, 2011; Yang & Jiang 2010). Research basin of the Yangtze River in China show that the cultivation of rice is slowly taking over, during the middle Holocene, greater importance in society that was previously very dependent on seasonal gathering acorns (Fuller & Qin, 2010; Fuller *et al.* 2007). Recent archaeological finds of ceramic fragments of cookware, which date back more than 10,000 years, found in the northern part of China, confirming that this early pottery was used for cooking grains, especially millet and acorns (Yang *et al.* 2014). Traces of eating acorns in prehistoric times were found during archaeological-botanical research in Kebara cave in Israel, based on the excavated plant remains from the Middle Paleolithic (Lev *et al.* 2005).

Third in importance is the whole area around the Mediterranean, from Turkey to Spain and other parts of Europe and the world (Saul *et al.* 2012). Archaeological records from 24 sites in the northwestern part of the Iberian Peninsula, which date from the Neolithic period, confirmed by regular practice of eating acorns (Antolín & Jacomet 2015), which also reveal the plant remains found in northern Greece (Valamoti 2015). Numerous finds dating from the late Mesolithic in southern Scandinavia, also show a significant use of acorns in the human diet, and even the management of oak forests for the production of acorns in northwest Europe (Regnell 2012; Regnell *et al.*, 1995; Mason 2000). Acorn in the Stone Age as a food source is mentioned in 1977 (Jorgensen, 1977).

Newer archaeobotanical and ethnographic research confirm that oak acorns were used as an important food source in Tunisia. In addition to being nutritionally highly valuable food source, its advantage was that it could easily keep for a long time (Morales *et al.* 2015). Acorns are especially rich in content of carbohydrates and fats, with a relatively high content of protein, fiber and ash, and they ate them as porridge or baked on a flat stone, after the removal of tannins immersion in mud, or rinsing in water. From the Middle Ages onwards, the acorn has got an important role in the production of meat by breeding pigs fed on acorns in the forest (Schneider 1990).

A growing awareness of the connection between diet and health resulted in the creation of a new concept of functional foods. IFIC (International Food Information Council) has given a definition, which says a functional food is that which provides greater health benefits than basic nutrition (Friganović *et al.* 2011). Despite the low representation of articles aimed at exploring the use of acorns in the diet of modern man, they confirm its nutritional value and antioxidant properties. In the area of Algiers, for acorn flour of three oak species, it was found that it does not contain tannic substances in amounts harmful to health. On the contrary, total polyphenols content is similar to that in other fruits and vegetables and is characterized by high antioxidant capacity (Benmahdi-Belarbi *et al.* 2007). Studies of probiotic potential and some functional properties of polysaccharides isolated from acorn fruit show that are not only suitable for technological application, but have properties of functional foods too (Tadayon *et al.* 2015). Popovic (Popovic *et al.* 2013) also states that, given the high antioxidant potential, acorn of pedunculate oak (*Quercus robur* L.) and sessile oak (*Q. petraea* L.) from the territory of Vojvodina, can be recommended as a source of natural antioxidant and a promising raw material for use in food industry and pharmaceutical industry. Rakic was investigating phenolic compounds and antioxidant activity of methanol extract of pedunculate oak and Turkey oak acorns (Rakic *et al.*, 2007; Rakic *et al.* 2006). The results confirm the high antioxidant value, which is by thermal treatment still increased, and that the pedunculate and Turkey oak acorns are suitable source for the preparation of functional foods. The content of phenols and tannins in oak acorns of different species varies. In one of the recent research of acorns from Polish, author describes the phytochemical parameters of more oak species (*Q. robur*, *Q. petraea*, *Q. pubescens*, *Q. rubra*). The amount of phenol in the acorn of *Q. robur* and *Q. petraea* is similar and tannins form a major component. *Q. pubescens* sample differs the lowest content of tannins and total phenols, and a relatively high amount of non-tannin phenols. *Q. rubra* had slightly lower tannin content than acorns of *Q. robur* and *Q. petraea*,

but other levels of phenols were much higher. Results for *Quercus robur* indicate geographical variability of phenol content, and the connection between phytochemical and biometric parameters of oak acorns (Luczaj *et al.* 2014).

Results of archaeological research confirm that the production of flour from acorns was a common practice throughout Europe at least 30 000 years ago (Revedin *et al.* 2015).

Oak acorns, used as food, appear in the archaeological findings in one of the oldest known remains of a town of Catal Huyuk (Čatal Hik) in Turkey, which date back to 6000 g. BC. There is information that the oak trees carefully inventoried during the reign of the Assyrian king Sargon II. The Grapčeva cave in Croatia, on the southern slopes of the island, near the village of Humac, is one of the oldest archaeological sites of the remains of civilization and culture in the Adriatic, which date back to between four and five thousand years before Christ. It is a key place for the Adriatic and the Mediterranean prehistory. Recent excavations on the site have revealed an abundance of plant residues. The most common are the remains of acorns of holm oak (*Quercus ilex L.*). It is assumed that during the Late Neolithic cave dwellers brought in some cereals and acorns collected from the wild, and as they are rich in carbohydrates, are considered to be the main source of food (Borojevic *et al.* 2008).

Archaeobotanical records reveal the use of acorns in times of famine and shortages in central Italy, a few years before the fall of the Roman Empire (Sadori & Susanna 2005). During the late Bronze Age, in southern France, the ancient inhabitants were gathering wild fruits, especially acorns (Bouby *et al.* 1999). One of the best-preserved examples of the Mesolithic in Europe, the period between 5600 - 400 BC, in Denmark, is Tybrind Vig. There were found fragments of acorn parenchyma, which were an important food for the survival of the people there (Kubiak-Martens 1999).

Despite the fact that our ancestors regularly consumed food of acorns, in its natural form, as the simplest form of functional foods, today bread from acorns is no longer part of the daily diet. We meet it in some parts of Italy (Sardinia), where it is still prepared in the traditional way, from local acorns with the addition of clay and ash, (Claudia 2013). Preparing of acorn cake is also recorded in Ogliastra, Italy (Pignone & Laghetti 2010), but that knowledge lives only in the memories of some elderly residents of rural areas. Acorn flour is regularly consumed just in few countries, such as Korea. Acorn starch has been explored by several authors (Cappai *et al.* 2013; Correia & Beirão-Da-Costa, 2010), and also boron content in frequently consumed acorn jelly (Choi & Jun 2008).

It is interesting that in the literature about nut allergy, acorn is recorded only in two cases (Roux *et al.*, 2003; Vega *et al.* 1998), and it was confirmed that due to its anti-inflammatory properties, acorn has a beneficial effect on the health of people with asthma. (Moon *et al.* 2013).

Popular literature, books and the Internet:

The following table (Table 2) shows the results that we have selected by using an Internet search engine.

Table 2. Review of information from the internet (Google web search)

Subject:	Uniform Resource Locator (Url):
The legislation of the Republic of Croatia on collecting acorns and other non-timber forest products	<p><i>Official sources:</i> http://narodne-novine.nn.hr/default.aspx http://portal.hrsume.hr/images/dok/proizvodi/Nedrvni%20proizvodi.pdf http://portal.hrsume.hr/images/dok/proizvodi/Nedrvni%20proizvodi%20cjenik_n.pdf http://portal.hrsume.hr/images/dok/proizvodi/Nedrvni%20proizvodi%20dozvola.pdf http://narodne-novine.nn.hr/clanci/sluzbeni/2006_10_111_2462.html http://narodne-novine.nn.hr/clanci/sluzbeni/2008_12_141_3935.html</p> <p><i>Unofficial sources:</i> http://casopis.hrsume.hr/pdf/196.pdf http://www.crpsisak.hr/wp-content/uploads/2014/08/Bro%C5%A1ura-%C5%A0umski_plodovi.pdf</p>
Acorns as Food, History, use, recipes, and bibliography	<p>https://www.academia.edu/3829415/Acorns_as_Food_Text_and_Bibliography (Uploaded by David A. Bainbridge)</p>
Suppliers and manufacturers of acorn flour and other flour-based products Acorn Flour Suppliers & Manufacturers	<p><i>America:</i> http://buyacornflour.com/ http://www.oakloreproducts.com/</p> <p><i>Europe and surrounding countries</i> http://www.bilje-zdravlje.com/knjiga-upoznaj-sebe.html http://www.agroklub.com/vocarstvo/hrvatski-ljekoviti-proizvodi-od-zira-prvi-europi/13525/ http://www.martinezvibes.com/hotdogdepot/ http://www.wildpantry.com/wildnuts.htm http://www.ekomarket.at/gefundene-produkten/eiche/</p> <p><i>Asia</i> http://qq791728113.en.ec21.com/ http://www.tradekorea.com/products/Acorn.html</p>
Allergy to acorns	(Vega <i>et al.</i> 1998)
The antioxidant properties of acorns	(Popović <i>et al.</i> 2013)
Other Literature	(Grić 2005), (Trinajstić 2007), (Friganović <i>et al.</i> 2011), http://books.wwnorton.com/books/Oak/
Traditional technology for gathering, processing and cooking	<p>http://www.californiaoaks.org/ExtAssets/acorns_and_eatem.pdf http://nativeamericannetroots.net/diary/1055 http://www.theatlantic.com/health/archive/2010/12/recipes-for-the-mighty-acorn-a-forager-experiments/67228/ http://www.dailykos.com/story/2011/09/07/1014246/-Indians-101-Acorns# http://www.thepeoplespaths.net/NAIFood/acorns.htm http://www.earthisland.org/journal/index.php/elist/eListRead/this_thanksgiving_consider_cooking_with_acorn_flour/ http://www.fs.fed.us/psw/publications/documents/psw_gtr217/psw_gtr217_39.pdf http://www.iloveacorns.com/ http://advancedsurvivalguide.com/wp-content/uploads/2014/03/Hatch-Acorn-Ind.-study.pdf</p>

The author of the best-known Croatian Encyclopedia of wild edible plants, Grlić, calls for changing the usual eating habits, as compared with the cultivated plants wild plants and their fruits have a higher nutritional value and are not so polluted by pesticides. In his work, the author has recorded use of acorns as bread grain among the Balkan people. In some parts of Macedonia, the poor population prepared bread from acorns ("želadov hleb") until the First World War, so that the acorn was baked, then ground and kneaded for bread. The use of flour from acorns was also known in Bosnia, Serbia and Montenegro, and during the Second World War, such bread was baked on some Croatian islands (Solta, Molat, Veli Iz). In the 19th century, bread made from acorn flour was eaten in Sweden and Norway, while in Ukraine acorn flour was mixed with flour from grain. In Sardinia farmers still make bread from the Holm oak (*Quercus ilex L.*). The acorn has been used as a substitute for coffee in Germany, peeled, fried, and milled, and acorns coffee (Eichelkaffe) is famous term (Grlić 2005).

Ecologist and writer Bainbridge, propagated acorns as an example of grain that grows on a tree. Oak is among the species that can play an important role in sustainable food production. Oak trees can be grown with less distortion of the annual agricultural ecosystems, and their deep roots can reach nutrients and water deep in the soil. They are adapted to temperate and semiarid climate and do not require intensive input of fertilizer and water. Until recently, the acorn was the staple food of people in many parts of the world and still is in a number of countries commercially exploited for food (in China, Korea and Japan). Food products from acorn are sold in the United States, in many Korean stores of imported and locally processed acorns. In San Diego, according to the author, in 2005 it was possible to buy starch and flour from acorns from four different companies, and products of acorns are also sold in the form of cubes, like tofu, and are used in cooking in the same way (Bainbridge 2006).

In recent decades the various websites, magazines and newspapers, recommended reintroduction of acorns in the diet of people. With growing interest in collecting local, edible wild plants, and the need for gluten free ingredients, acorn could be on the way of food recovery. As part of this trend, coffee from acorns appeared in health food stores in Poland and many other countries (Łuczaj *et al.* 2012). In Estonia, in health food stores, mainly the products of non - local origin are offered. Articles published in Scientific American (Starin 2014) and NPR (D. Pritchep 2014) launched a new interest in products based on acorns. The first who responded were small family producers. In Texas recently started a new promotional campaign of manufacturer named Mighty Wild, for the production and sales of gluten-free vegan crackers, with a few different flavors, made from the acorn of local origin (<http://www.mightywild.com/buy-acorn-crackers>). In California Sue's Acorn Café & Mill (<http://www.buyacornflour.com/about.php>) sells a wide range of bakery products and flour made from acorns. South Korea is one of the few countries where the acorn has never disappeared from the diet. Dotorimuk is a traditional dish, made of acorn starch. Gathering acorns is an important source of income for small farmers in the villages of South Korea (L.Smith 2014) (<https://translate.google.hr/?hl=en&tab=wT#en/hr/countryside>). However, competition from China has pushed

domestic acorn processing industry by placement of acorn flour and starch at lower prices (<http://qq791728113.en.ec21.com/>).

At the same time, in Europe and in the region, some local producers and collectors are trying to get acorns from oblivion. In Germany, we find a product called "NewTella", sweet acorn spread, (<http://www.eattheweeds.com/acorns-the-inside-story/>). In Croatia exists a similar product under the name "Žirko" (<http://www.agroklub.com/vocarstvo/hrvatski-ljekoviti-proizvodi-od-zira-prvi-u-europi/13525/>), and in Serbia, it is "Žirkomed", (<http://www.bilje-zdravlje.com/knjiga-upoznaj-sebe.html>).

Both manufacturers in the product range offer drinks from roasted and ground acorns and flour made from acorns. Manufacturer in Serbia offers another product "Žirkosir" and powder mixture as a complete meal named "Kosmajski šejk". Acorn flour from produced from locally collected acorns at a low heat treatment is recommended as a supplement up to the 20 % whole grain flour. It is used for making bread, pastries, pancakes, cakes and other products. In Slovakia is acorn flour produced from controlled organic farming. They recommend their customers the use of the flour in the ratio of 1: 3, together with wheat flour to produce bread dough, biscuits, cakes and other sweets. They say that the acorn flour is a complete substitute for wheat flour in the chopped steak with vegetables, potato pancakes and omelets, and the declaration stated nutritional values on the dry product: sodium 17 mg/kg; potassium 4500 mg/kg; phosphorus 730 mg/kg; calcium 740 mg/kg; magnesium 340 mg/kg; 16.8 % fiber; 4.1 % protein; unsaturated fatty acids 5.1 %; minerals 1.2 %; and carbohydrates 72.8 % (<http://www.ekomarket.at/gefundene-produkten/eiche/>). On the Greek island of Kea, Marcie Mayer launched Hamada initiative to revive the island's tradition of processing acorns (<http://iloveacorns.com>). They buy acorns collected by local residents and create their own range of products based on flour, from biscuits to the gluten-free, vegan bun. Hamada has brought together two seemingly disparate items. On the one hand, it encourages the development of local people which generates revenue by selling the collected acorns, on the other hand, revenue stream encourages local people to preserve the environment (particularly oak trees) and cultivate traditional heritage.

In Figure 1. we showed schematic diagram of the possibility of using acorn flour in flour-based products obtained by data analysis. On the left side are products that were consumed in the past and have been known from the historical and archaeological records. On the right side are the products that today's consumers are interested in and accessible, and we found them mainly through the website. Possibilities of using acorn flour in flour-based products are varied. The product range consists of bread, cakes, cookies, muffins, acorn starch noodles (dotori guksu), acorn starch jelly (dotorimuk), acorn coffee, sweet spreads and powder mixture for shake. Different possibilities of application were stated by manufacturers on declarations of their products, and they recommend it as total or partial substitute for other grain flour in bakery products, as well as the addition to the chopped vegetable steaks, omelets, soups, or for their thickening. In the recent history acorn flour was used only in the times of famine, but today a group of exclusive products appears for the consumers with specific needs, such as certified organic products, gluten – free products and vegetarian and vegan products. Acorn flour and acorn flour based products satisfy all these criteria. We can see that throughout history types of acorn

products changed, from simple soup and unleavened bread, through very sophisticated products in some Asian countries, to the exclusive products sold in specialty shops or as a part of attractive tourist offer in Spain and Italy.

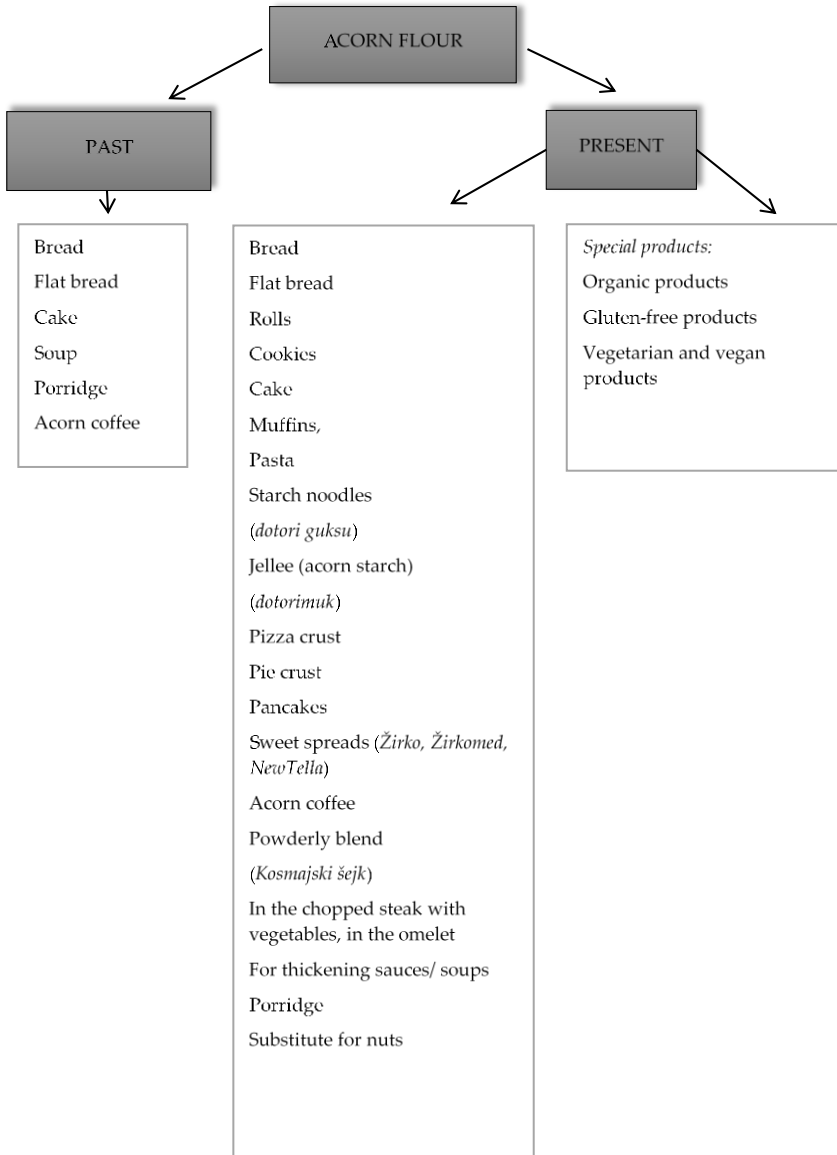

Figure 1. Examples of products based on Acorn Flour

Acorn as a raw material is literally all around us, in the parks, alleys, gardens and forests. Its collection in forests that are owned by the Republic of Croatia is regulated by a range of legislation such as the Law on Forests, the Nature Protection Act, the Rules on the use of non-timber forest products and Forest management plans, and needs prior permission of the Croatian Forests Ltd., a company owned by the state. To collect acorns, either for personal use or for the purpose of processing, trade and other business, you have to pay certain fees. We have shown current legislations in Table 2.

CONCLUSIONS

Newer and older, archaeobotanical researches confirm that the oak acorn (*Quercus*) has been used since prehistoric times for feeding people in various cultures around the world. At the same time, tools and technologies for the processing of acorns into flour have been developed. Throughout history, the types of products made from flour changed, from a simple soup, via unleavened bread to highly sophisticated products in some Asian countries. In the recent history acorn flour was used only in times of famine. Today the spread is present only in some countries, as a part of the diet of ethnic groups (America, Asia), or as a part of a culinary experiment of nature lovers and collectors of edible wild plants. However, following the trend of the market, a group of special acorn products developed (organic, vegan, vegetarian and gluten-free products) for a specific group of consumers. Recently, acorn flour products appear as a part of tourism, in campaigns that promote traditional local cuisine and customs (Spain, Sardinia). Scientific studies confirm that flour from acorns, considering the nutritional value and antioxidant potential, can be considered a functional food or food whose nutritional bioactive components have beneficial health effects on the human body. The acorn is suitable as a material for organic production, if collected under control, unlike the conventional grains which are generally treated with pesticides. Possibilities of using flour from acorns in flour-based products are varied. The product range of acorn flour, which is already on the market, consists of bread, cakes, cookies, muffins, acorn starch noodles (dotori guksu), acorn starch jelly (dotorimuk), acorn coffee, sweet spreads and Powderly shake mixture. It can be used as a complete or partial replacement for the cereal flour in bakery products, as well as the addition to chopped steaks with vegetables, omelets, soups, or thickening of the same.

Analysis of literature in Croatia reveals a lack of research opportunities using acorn flour in flour-based products, and generally refers to the need for greater representation of these issues in the future.

REFERENCES

- Antolín, F. & Jacomet, S., 2015. Wild fruit use among early farmers in the Neolithic (5400–2300 cal bc) in the north-east of the Iberian Peninsula: an intensive practice? *Vegetation History and Archaeobotany*, 24(1), pp.19–33. Available at <http://link.springer.com/10.1007/s00334-014-0483-x>.
- Bainbridge, D. a., 2006. Acorns as Food , (January), pp.1–32. Available at https://www.academia.edu/3829415/Acorns_as_Food_Text_and_Bibliography.
- Benmahdi-Belarbi, M., Vassilev, G. & Mashev, N., 2007. Contribution to the investigation of food and antioxidant value of acorns of various oak species spread in the Tlemsen region (Algeria). *Oxidation Communications*, 30(1), pp.77–81. Available at <http://www.scopus.com/inward/record.url?eid=2-s2.0-34248579598&partnerID=tZOtx3y1>.
- Borojević, K. *et al.*, 2008. Plant use at Grapčeva cave and in the eastern Adriatic Neolithic. *Journal of Field Archaeology*, 33(3), pp.279–303. Available at <http://www.scopus.com/inward/record.url?eid=2-s2.0-60949347923&partnerID=tZOtx3y1>.
- Bouby, L., Leroy, F. & Carozza, L., 1999. Food plants from late Bronze age lagoon sites in Languedoc, southern France: Reconstruction of farming economy and environment. *Vegetation History and Archaeobotany*, 8(1-2), pp.53–69. Available at <http://www.scopus.com/inward/record.url?eid=2-s2.0-0033148098&partnerID=40&md5=727cae0515adabe86c762557bb924f82>.
- Cappai, M.G. *et al.*, 2013. Electron microscopy and composition of raw acorn starch in relation to in vivo starch digestibility. *Food & function*, 4(6), pp.917–22. Available at <http://www.scopus.com/inward/record.url?eid=2-s2.0-84878717676&partnerID=tZOtx3y1> [Accessed July 20, 2015].
- Choi, M.-K. & Jun, Y.-S., 2008. Analysis of Boron Content in Frequently Consumed Foods in Korea. *Biological Trace Element Research*, 126(1-3), pp.13–26. Available at <http://dx.doi.org/10.1007/s12011-008-8179-7>.
- Claudia, P., 2013. Acorn bread: A traditional food of the past in Sardinia (Italy). *Journal of Cultural Heritage*, 14(3), pp.S71–S74. Available at <http://www.sciencedirect.com/science/article/pii/S1296207413000228> [Accessed June 7, 2015].
- Correia, P.R. & Beirão-Da-Costa, M.L., 2010. Chestnut and acorn starch properties affected by isolation methods. *Starch/Staerke*, 62(8), pp.421–428.
- D. Pritchep, 2014. Nutritious Acorns Don't Have To Just Be Snacks For Squirrels : The Salt : NPR. NPR. Available at: <http://www.npr.org/sections/thesalt/2014/10/24/358527018/nutritious-acorns-dont-have-to-just-be-snacks-for-squirrels> [Accessed October 8, 2015].
- Friganović, E. *et al.*, 2011. FUNKCIONALNA HRANA I POTROŠAČI. *Praktični menadžment, stručni časopis za teoriju i praksu menadžmenta*, 2(1), pp.51–57.
- Fuller, D.Q., Harvey, E. & Qin, L., 2007. Presumed domestication? Evidence for wild rice cultivation and domestication in the fifth millennium BC of the Lower Yangtze region. *Antiquity*, 81(September 2006), pp.316–331. Available at <http://discovery.ucl.ac.uk/1347896/>.
- Fuller, D.Q. & Qin, L., 2010. Declining oaks, increasing artistry, and cultivating rice: the environmental and social context of the emergence of farming in the Lower Yangtze Region. *Environmental Archaeology*, 15(2), pp.139–159. Available at <http://www.maneyonline.com/doi/abs/10.1179/146141010X12640787648531>.

- Gremillion, K.J., 2002. Foraging Theory and Hypothesis Testing in Archaeology: An Exploration of Methodological Problems and Solutions. *Journal of Anthropological Archaeology*, 21(2), pp.142–164. Available at <http://linkinghub.elsevier.com/retrieve/pii/S0278416501903915>.
- Grić, L., 2005. Enciklopedija samoniklog jestivog bilja Treće izda., Rijeka: Rijeka: Ex libris, 2005 - (Biblioteka Natura; knj. 1).
- Ivanhoe, F., 1995. Secular decline in cranoskeletal size over two millennia of interior central California prehistory: Relation to calcium deficit in the reconstructed diet and demographic stress. *International Journal of Osteoarchaeology*, 5(3), pp.213–253. Available at: <http://dx.doi.org/10.1002/oa.1390050303>.
- Ivanhoe, F. & Chu, P.W., 1996. Cranoskeletal Size Variation in San Francisco Bay Prehistory: Relation to Calcium Deficit in the Reconstructed High-seafoods Diet and Demographic Stress. *International Journal of Osteoarchaeology*, 6(4), pp.346–381. Available at <http://www.scopus.com/inward/record.url?eid=2-s2.0-0345839832&partnerID=tZOTx3y1>.
- Jorgensen, G., 1977. Acorns as a food- source in later stone- age. , pp.233–238.
- Kubiak-Martens, L., 1999. The plant food component of the diet at the late Mesolithic (Ertebølle) settlement at Tybrind Vig, Denmark. *Vegetation History and Archaeobotany*, 8(1-2), pp.117–127. Available at <http://www.scopus.com/inward/record.url?eid=2-s2.0-0033147709&partnerID=40&md5=0bde223cfb9a4f358f4f31e5a2462260>.
- L.Smith, 2014. ACORNS: The Most Overlooked Food In America. Available at: http://www.foodday.org/acorns_the_most_overlooked_food_in_america [Accessed October 8, 2015].
- Lev, E., Kislev, M.E. & Bar-Yosef, O., 2005. Mousterian vegetal food in Kebara Cave, Mt. Carmel. *Journal of Archaeological Science*, 32(3), pp.475–484. Available at <http://linkinghub.elsevier.com/retrieve/pii/S0305440304001694>.
- Liu, L. *et al.*, 2011. Plant exploitation of the last foragers at Shizitan in the Middle Yellow River Valley China: evidence from grinding stones. *Journal of Archaeological Science*, 38(12), pp.3524–3532. Available at: <http://www.sciencedirect.com/science/article/pii/S0305440311002949> [Accessed October 4, 2015].
- Luczaj, Ł. *et al.*, 2012. Wild food plant use in 21st century Europe: The disappearance of old traditions and the search for new cuisines involving wild edibles. *Acta Societatis Botanicorum Poloniae*, 81, pp.359–370.
- Luczaj, L., Adamczak, A. & Duda, M., 2014. Tannin content in acorns (*Quercus* spp.) from Poland. , 72, pp.103–111.
- Mason, S.L.R.L.R., 2000. Fire and Mesolithic subsistence — managing oaks for acorns in northwest Europe? *Palaeogeography, Palaeoclimatology, Palaeoecology*, 164(1-4), pp.139–150. Available at <http://www.sciencedirect.com/science/article/pii/S0031018200001814> [Accessed July 20, 2015].
- McCorriston, J., 1994. Acorn eating and agricultural origins: California ethnographies as analogies for the ancient Near East. *Antiquity*, 68(258), pp.97–107. Available at: <http://dx.doi.org/10.1017/S0003598X00046238>.
- McCreary, D., 2004. Managing and restoring California's oak woodlands. *Natural Areas Journal*, 24(3), pp.269–275. Available at <Go to ISI://000222614700013.
- Moon, H.R. *et al.*, 2013. Antiasthma Effects Through Anti-Inflammatory Action Of Acorn (*Quercus Acutissima* Carr.) In Vitro And In Vivo. *Journal of Food Biochemistry*, 37(1), pp.108–118.

- Morales, J. *et al.*, 2015. First preliminary evidence for basketry and nut consumption in the Capsian culture (ca. 10,000–7500BP): Archaeobotanical data from new excavations at El Mekta, Tunisia. *Journal of Anthropological Archaeology*, 37, pp.128–139. Available at http://apps.webofknowledge.com/full_record.do?product=WOS&search_mode=GeneralSearch&qid=7&SID=V27vfEBT3npU6mxBegx&page=1&doc=4 [Accessed July 20, 2015].
- Morgan, C., 2012. Modeling Modes of Hunter-Gatherer Food Storage. *American Antiquity*, 77(4), pp.714–736.
- Nixon, K.C., 1993. Infrageneric classification of *Quercus* (Fagaceae) and typification of sectional names. *Ann. For. Sci.*, 50(Supplement), p.25s–34s. Available at <http://dx.doi.org/10.1051/forest:19930701>.
- Pignone, D. & Laghetti, G., 2010. On sweet acorn (*Quercus* spp.) cake tradition in Italian cultural and ethnic islands. *Genetic Resources and Crop Evolution*, 57(8), pp.1261–1266. Available at <http://dx.doi.org/10.1007/s10722-010-9625-x>.
- Popović, B.M. *et al.*, 2013. Antioxidant characterization of oak extracts combining spectrophotometric assays and chemometrics. *The Scientific World Journal*, 2013.
- Pringle, H., 2008. Society for American Archaeology meeting. Herring and nuts for the “salmon people”. *Science* (New York, N.Y.), 320(5873), pp.174–175. Available at <http://www.scopus.com/inward/record.url?eid=2-s2.0-42449119696&partnerID=40&md5=c700302c8427ada50c5fbd63c9a3ce8a>.
- Rakić, S. *et al.*, 2007. Influence of thermal treatment on phenolic compounds and antioxidant properties of oak acorns from Serbia. *Food Chemistry*, 104(2), pp.830–834. Available at <http://www.scopus.com/inward/record.url?eid=2-s2.0-34247487427&partnerID=tZOtx3y1> [Accessed June 6, 2015].
- Rakić, S. *et al.*, 2006. Oak acorn, polyphenols and antioxidant activity in functional food. *Journal of Food Engineering*, 74(3), pp.416–423. Available at <http://www.scopus.com/inward/record.url?eid=2-s2.0-31644432659&partnerID=tZOtx3y1> [Accessed June 6, 2015].
- Regnell, M., 2012. Plant subsistence and environment at the Mesolithic site Tågerup, southern Sweden: new insights on the “Nut Age.” *Vegetation History and Archaeobotany*, 21(1), pp.1–16. Available at <http://dx.doi.org/10.1007/s00334-011-0299-x>.
- Regnell, M. *et al.*, 1995. Reconstruction of environment and history of plant use during the late Mesolithic (Ertebølle culture) at the inland settlement of Bökeberg III, southern Sweden. *Vegetation History and Archaeobotany*, 4(2), pp.67–91. Available at <http://www.scopus.com/inward/record.url?eid=2-s2.0-0002890830&partnerID=40&md5=39f2471676933618dead30122c21a6fa>.
- Revedin, A. *et al.*, 2015. New technologies for plant food processing in the Gravettian. *Quaternary International*, 359–360, pp.77–88. Available at: <http://www.sciencedirect.com/science/article/pii/S1040618214007241> [Accessed August 20, 2015].
- Roux, K.H., Teuber, S.S. & Sathe, S.K., 2003. Tree Nut Allergens. *International Archives of Allergy and Immunology*, 131(4), pp.234–244. Available at <http://www.karger.com/DOI/10.1159/000072135>.
- Sadori, L. & Susanna, F., 2005. Hints of economic change during the late Roman Empire period in central Italy: a study of charred plant remains from “La Fontanaccia”, near Rome. *Vegetation History and Archaeobotany*, 14(4), pp.386–393. Available at <http://www.scopus.com/inward/record.url?eid=2-s2.0-33644688148&partnerID=tZOtx3y1> [Accessed July 20, 2015].

- Saul, H. *et al.*, 2012. A systematic approach to the recovery and identification of starches from carbonised deposits on ceramic vessels. *Journal of Archaeological Science*, 39(12), pp.3483–3492. Available at: <http://www.sciencedirect.com/science/article/pii/S0305440312002816> [Accessed October 8, 2015].
- Schneider, M., 1990. Acorns as a staple food-different types and change of exploitation through time. *Bodenkultur*, 41(1), pp.81–88.
- Starin, D., 2014. Is Reintroducing Acorns into the Human Diet a Nutty Idea?. *Scientific American*. Available at: <http://www.scientificamerican.com/article/is-reintroducing-acorns-into-the-human-diet-a-nutty-idea/> [Accessed August 1, 2015].
- Stevens, N.E. & McElreath, R., 2015. When are two tools better than one? Mortars, millingslabs, and the California acorn economy. *Journal of Anthropological Archaeology*, 37, pp.100–111. Available at: http://apps.webofknowledge.com/full_record.do?product=WOS&search_mode=GeneralSearch&qid=7&SID=V27vfEBT3npU6mxBegx&page=1&doc=3 [Accessed August 23, 2015].
- Tadayoni, M., Sheikh-Zeinoddin, M. & Soleimani-Zad, S., 2015. Isolation of bioactive polysaccharide from acorn and evaluation of its functional properties. *International Journal of Biological Macromolecules*, 72, pp.179–184. Available at <http://search.ebscohost.com/login.aspx?direct=true&db=ffh&AN=2015-04-Js2581&lang=hr&site=ehost-live>.
- Trinajstić, I., 2007. O problemu međusobnog razlikovanja hrastova *Quercus pubescens* Willd. i *Quercus virgiliana* (Ten.) Ten. *Šumarski list*, 131(1-2), pp.57–60.
- Tushingham, S. & Bettinger, R.L., 2013. Why foragers choose acorns before salmon: Storage, mobility, and risk in aboriginal California. *Journal of Anthropological Archaeology*, 32(4), pp.527–537. Available at <http://linkinghub.elsevier.com/retrieve/pii/S0278416513000512>.
- Valamoti, S., 2015. Harvesting the “wild”? Exploring the context of fruit and nut exploitation at Neolithic Dikili Tash, with special reference to wine. *Vegetation History and Archaeobotany*, 24(1), pp.35–46. Available at <http://dx.doi.org/10.1007/s00334-014-0487-6>.
- Vega, A. *et al.*, 1998. Anaphylactic reaction to ingestion of *Quercus ilex* acorn nut. *Clinical Experimental Allergy*, 28(6), pp.739–742. Available at: <http://www.scopus.com/inward/record.url?eid=2-s2.0-0031859667&partnerID=tZOtx3y1> [Accessed September 13, 2015].
- Yang, X. *et al.*, 2014. Starch grain evidence reveals early pottery function cooking plant foods in North China. *Chinese Science Bulletin*, 59(32), pp.4352–4358. Available at <http://dx.doi.org/10.1007/s11434-014-0500-6>.
- Yang, X.Y. & Jiang, L.P., 2010. Starch grain analysis reveals ancient diet at Kuahuqiao site, Zhejiang Province. *Chinese Science Bulletin*, 55(12), pp.1150–1156.

Regulations:

<http://narodne-novine.nn.hr/default.aspx>

<http://portal.hrsume.hr/images/dok/proizvodi/Nedrvni%20proizvodi.pdf>

http://portal.hrsume.hr/images/dok/proizvodi/Nedrvni%20proizvodi%20cjenik_n.pdf

<http://portal.hrsume.hr/images/dok/proizvodi/Nedrvni%20proizvodi%20dozvola.pdf>

http://narodne-novine.nn.hr/clanci/sluzbeni/2006_10_111_2462.html

http://narodne-novine.nn.hr/clanci/sluzbeni/2008_12_141_3935.html

Web pages:

https://www.academia.edu/3829415/Acorns_as_Food_Text_and_Bibliography
<http://buyacornflour.com/>
<http://www.oakloreproducts.com/>
<http://www.bilje-zdravlje.com/knjiga-upoznaj-sebe.html>
<http://www.agroklub.com/vocarstvo/hrvatski-ljekoviti-proizvodi-od-zira-prvi-u-europi/13525/>
<http://www.martinezvibes.com/hotdogdepot/>
<http://www.wildpantry.com/wildnuts.htm>
<http://www.ekomarket.at/gefundene-produkten/eiche/>
<http://qq791728113.en.ec21.com/>
<http://www.tradekorea.com/products/Acorn.html>
<http://books.wwnorton.com/books/Oak/>
http://www.californiaoaks.org/ExtAssets/acorns_and_eatem.pdf
<http://nativeamericannetroots.net/diary/1055>
<http://www.theatlantic.com/health/archive/2010/12/recipes-for-the-mighty-acorn-a-forager-experiments/67228/>
<http://www.dailykos.com/story/2011/09/07/1014246/-Indians-101-Acorns#>
<http://www.thepeoplespaths.net/NAIFood/acorns.htm>
http://www.earthisland.org/journal/index.php/elist/eListRead/this_thanksgiving_consider_cooking_with_acorn_flour/
http://www.fs.fed.us/psw/publications/documents/psw_gtr217/psw_gtr217_39.pdf
<http://www.iloveacorns.com/>
<http://advancedsurvivalguide.com/wp-content/uploads/2014/03/Hatch-Acorn-Ind.-study.pdf>

DIRECT POTENTIOMETRY STUDY OF AMYLOSE AND CETYLPYRIDINIUM CHLORIDE INTERACTION

UDC 664.23 : 543.554

Maja Karniš¹, Hrvoje Babić¹, Marko Ivić¹, Saulo Borges², Nikola Sakač^{1}*

¹*Department of Chemistry, Josip Juraj Strossmayer University of Osijek, Cara Hadrijana 8a, Osijek, HR-31000, Croatia*

^{*}*Corresponding author: nsakac@kemija.unios.hr*

²*Faculdade de Paulínia, R. Nelsom Prodóximo, 495 - Bela Vista, Paulínia - SP, 13140-000, Brazil*

ABSTRACT

Starch consists of two polymer molecules; linear amylose and branched amylopectin. Pure or hydrated amylose forms a double helix crystal with a hydrophilic outside surface and a hydrophobic inner cavity. The inner cavity is suitable for forming the inclusion complex with various hydrophobic ligands such as iodine, alcohol, fatty acids and surfactants. Surfactants, like cetylpyridinium chloride (CPC), are surface active agents. They consist of two parts, a hydrophilic head group, and a hydrophobic tail.

In food processing, surfactants are used as emulsifiers and form the starch-surfactant inclusion complex. This interaction has an effect on the swelling and pasting properties of starch and the characteristics of the resulting starch pastes. Physical properties of amylose-surfactant inclusion complex have provided valuable insights into the functionality of surfactants in starch-containing food systems. Techniques, such as x-ray diffraction, differential scanning calorimetry, nuclear magnetic resonance and others, are very useful but expensive and time-consuming.

The aim of this work was to study the formation of amylose-CPC complex in aqueous media, using simple surfactant electrode and direct potentiometric methodology. Parameters, such as the change of slope, linear region and critical micellar concentration were observed. Additionally, the interaction was observed by infrared spectroscopy.

Keywords: amylose, inclusion complex, surfactant, cetylpyridinium chloride

INTRODUCTION

Starch is the major polysaccharide reserve in plants. It is present in the form of granules that are comprised of two polymers: amylose and amylopectin. Amylose is a linear polymer composed of glucopyranose units linked through α -D-(1 \rightarrow 4) glycoside linkages. Amylose is an unbranched chain coiled in the shape of a helix. Amylopectin is a branched polymer in which units are linked through α -D-(1 \rightarrow 6) glycoside linkages and has one of the highest molecular weights among naturally occurring polymers (Karim *et al.*, 2000).

Starch complexing agents include molecules with a lipophilic group and a diameter of 4.5–6 Å (Fig. 1). For example, triiodide ions readily form inclusion complexes with starch. This

allows starch to be used as an indicator in the titrimetric determination of iodine (Hasenhuettl, 2008).

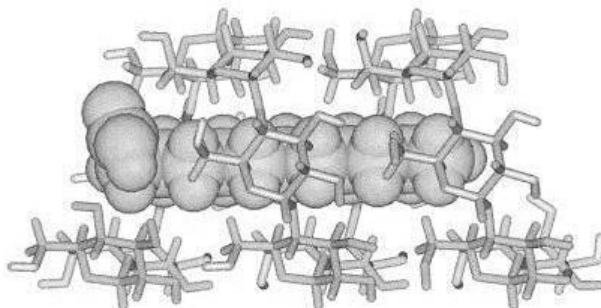

Figure 1. Amylose-ligand inclusion complex

Amylose and amylopectin complexes with lipids can be differentiated by their physical properties. Amylopectin complexes are more soluble in aqueous systems than amylose complexes, and saturated fatty acids have been used to selectively precipitate amylose from solution (Schoch and Williams, 1944). Other molecules that can also form inclusion complex with starch are dimethyl sulfoxide, linear alcohols and surfactants (Lundquist *et al.*, 2002).

Surfactants are molecules that consist of two parts, hydrophilic (polar group) and hydrophobic (usually long alkyl chain). The hydrophilic part of the surfactant is usually called the head and the hydrophobic part the tail. Surfactants are commonly classified in groups based on the polar head group charge. Therefore, surfactants can be anionic, cationic, non-ionic or amphoteric (Jönsson *et al.*, 1998).

An important consequence of the amphiphilic character of surfactants is their tendency to self-associate as their concentration increases in the solution. The concentration at which they start to self-associate is referred to as the critical micelle concentration, cmc. The micellisation occurs as a compromise between the effects that favor aggregation (hydrophobic effect), and those that oppose to it (electrostatic and/or steric repulsion between surfactant head groups) (Mira, 2006).

In food processing, surfactants are used as emulsifiers because they form the starch-surfactant inclusion complex. This interaction has an effect on the swelling and pasting properties of starch (Hasenhuettl, 2008). A wide range of surfactants and their combinations are used in the production of bakery food products. This is due to development of different chemical structures which have to meet the specific production needs. Some surfactants also react with proteins in dough and have a role in strengthening its properties during production stress. These surfactants are classified as dough

conditioners, while those who favor the starch complexation are called crumb softeners (Zobel and Kulp, 1996).

Physical properties of starch-surfactant inclusion complexes have provided insights into the functionality of surfactants in various foods. Many techniques, such as x-ray diffraction, differential scanning calorimetry, nuclear magnetic resonance, electron spin resonance, rheology have proven useful, but most of them are very expensive and time-consuming. The aim of this work was to study the formation of amylose-CPC complex in aqueous media, using surfactant electrode and direct potentiometry as a rapid and inexpensive technique (Madunić-Čačić *et al*, 2008). Additionally, the interaction was observed by infrared spectroscopy (IR).

MATERIALS AND METHODS

Reagents

Amylose, cetylpyridiniumchloride (CPC) and KBr were purchased from Sigma Aldrich (Germany). Solutions were prepared using ultrapure deionised water.

Apparatus

A Metrohm 780 pH meter, 728 Stirrer, 765 Dosimat (all from Metrohm, Switzerland) were used along with custom-made software. A silver/silver (I) chloride electrode (Metrohm, Switzerland) served as the reference electrode and a surfactant DMI-TPB based electrode as indicating one.

IR measurements were performed using FTIR 8400S (Shimadzu, Japan).

Solution preparation

The amylose solutions were prepared by the addition of 0.05, 1, 2 and 4 g, of amylose to deionised water in closed 100 mL volumetric flasks. After the solutions were heated and stirred for 10 min, they were allowed to cool to room temperature and then diluted to 100 mL with deionized water, thus yielding 0.05, 1, 2 and 4 w/v % solutions. These solutions were used for further investigations.

CPC (5mM) surfactant solution was prepared in deionised water.

Direct potentiometric measurements

To the 20 mL amylose solutions the 5 mM CPC solution was incrementally added, reaching 20 mL in final volume. The increment volume was 0,1 mL, in 60 s interval time. During measurements, the solutions were continuously stirred.

IR measurements

First, the amylose-CPC solution was prepared by mixing 20 mL of 2 w/v % amylose solution and 20 mL of CPC solution (generating the end conditions of direct

potentiometric measurement). Then, the amylose-CPC precipitate was left to dry. The IR measurements were performed using sample-KBr pellets. Pure CPC and amylose were measured the same way.

RESULTS AND DISCUSSION

The surfactant electrode response was measured after incremental additions of the CPC to the pure deionised water (marked as 0 w/v % in Fig. 2), showing linear response in the wide concentration range ($\log c(\text{CPC})$ -5 up to -3). After measuring the same incremental additions of the CPC to the amylose solutions ranging from 0.05 to 4 w/v %, there appeared a significant linear response region decrease and shift towards higher CPC concentration as shown in Figure 2. This change in electrode response was more noticeable for amylose solutions above 1 w/v %, while the response of CPC in 0.05 w/v % still indicated some characteristics of the electrode response in pure water. The cmc concentration in all amylose solutions was moved to higher CPC concentration. These results indicated that the formation of the amylose-CPC inclusion complex could be monitored using surfactant electrode.

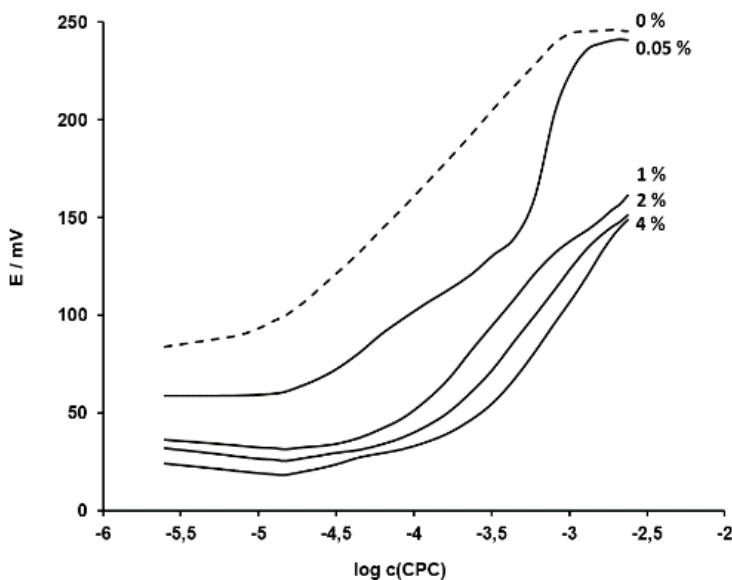

Figure 2. Direct potentiometric response of surfactant electrode towards CPC at different amylose concentrations (0-4 w/v %).

IR spectra were taken for pure amylose sample, pure CPC and 2w/v % amylose-CPC sample (Fig. 3). Comparing the obtained data in the fingerprint region of the spectra

indicates that the three samples are different compounds. IR spectrum for 2w/v % amylose-CPC displayed the spectra similar to that of amylose, but with specific CPC peaks at 1550, 1250-1350 and 900 cm⁻¹, as a result of amylose-CPC inclusion complex.

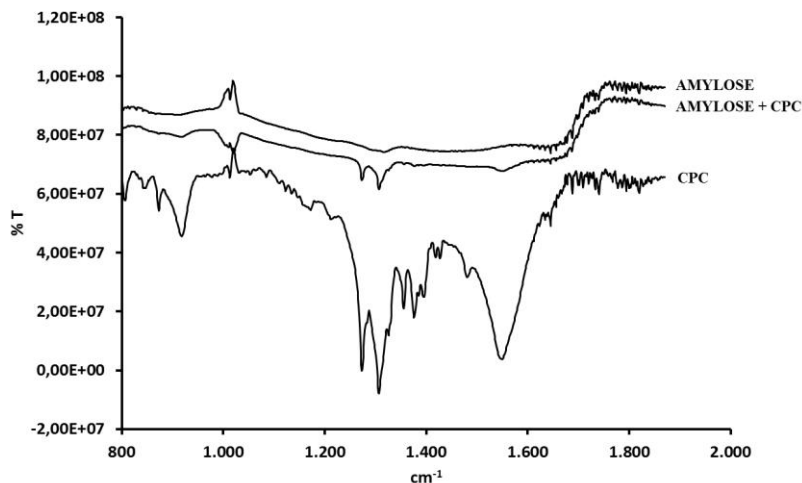

Figure 3. IR spectra of pure amylose sample, pure CPC and 2 w/v % amylose-CPC sample (the end concentrations as for direct potentiometric measurement).The data have been arranged for clarity.

CONCLUSIONS

The presented direct potentiometric data showed possibilities for measuring amylose inclusion complex with CPC using surfactant electrode. Observed changes in the electrode response signal between pure water and amylose solutions indicate the formation of amylose-CPC inclusion complex. IR spectrum of amylose-CPC complex confirmed the formation of complex by displaying the amylose-CPC complex spectra as an amylose spectra with specific CPC peaks.

Presented methodology uses simple apparatus and instrumentation, and is less expensive and time-consuming than other techniques.

REFERENCES

- Hasenhuettl G.L., (2008) Emulsifier-Carbohydrate Interactions. In: Hasenhuettl GL, Hartel RW, editors. Food emulsifiers and their applications, 2nd ed. New York: Springer; pp. 65-69.
- Jönsson, B.; Lindman, B.; Holmberg, K.; Kronberg, B. (1998), Surfactants and polymers in aqueous solution. John Wiley & Sons Ltd.: West Sussex, pp. 438.
- Karim, A. A., Norziah, M. H., Seow, C. C. (2000). Methods for the study of starch retrogradation, Food Chemistry, 71 (1), 9-36.
- Lundquist, H.; Eliasson, A.C.M., Olofsson, G. (2002). Binding of hexadecyltrimethylammonium bromide to starch polysaccharides. Part I. Surface tension measurements. Carbohydr. Polym., 49, pp. 43-55
- Madunić-Čačić D., Sak-Bosnar M., Galović O., Sakač N., Matešić-Puač R. (2008). Determination of cationic surfactants in pharmaceutical disinfectants using a new sensitive potentiometric sensor. Talanta, 76 (2), 259-64
- Mira I., (2006) Interactions between Surfactants and Starch: from Starch Granules to Amylose Solutions, Doctoral thesis at the Royal Institute of Technology Stockholm
- Schoch, T., Williams, C. (1944). Adsorption of Fatty Acid by the Linear Component of Corn Starch. J. Am. Chem. Soc. 66: 1232-3.
- Zobel, H.F., Kulp, K. (1996) The staling mechanism. In: Baked Goods Freshness: Technology, Evaluation, and Inhibition of Staling, Hebeda R., Zobel H.F (ed.), Marcel Dekker Inc., New York, pp 1-64.

BROWNING DEVELOPMENT IN BAKERY PRODUCTS ENRICHED WITH FOOD INDUSTRY BY-PRODUCTS

UDC 664.661

Jasmina Lukinac, Marko Jukić, Frane Čačić Kenjerić, Paola Kolak**, Tamara Efendić**, Daliborka Koceva Komlenić*

*Josip Juraj Strossmayer University of Osijek, Faculty of Food Technology Osijek, Franje Kuhača 20, HR-31000 Osijek, Croatia (**Student of Faculty of Food Technology Osijek)*

**Corresponding author: marko.jukic@ptfos.hr*

ABSTRACT

During baking, the formation of colour is due to the Maillard reaction, and caramelization of sugars. The formation of colour in bakery products during baking is widely known as browning. As well as baking, the development of browning in bakery products is a simultaneous heat and mass transfer process that occurs mostly in a non-ideal system under non-ideal conditions. Besides the major influence of this phenomenon on the initial acceptance of products by consumers, it is the responsible for other relevant changes occurring in food during baking, i.e. production of flavour and aroma compounds, formation of toxic products (e.g. acrylamide), and decrease of nutritional value of proteins. The present work investigates the effect of some dietary fibers from different origins (apple pomace (AP), brewers' spent grain (BSG)) on the bread crust and crumb colour changes during baking. AP, as inexpensive and primary by-product of apple juice and cider production, is a good source of dietary fibers, polyphenols and pectin. BSG is the major by-product of the brewing industry and a good source of protein, cellulose, noncellulosic polysaccharides, chiefly arabinoxylans and lignin.

Because of that, the aim of this study was to investigate the effect of AP and BSG addition (5, 10 and 15 %) on bread crust and crumb colour. Colour was measured using a colorimeter. Lightness, redness and yellowness of bread samples fortified with different percentages of BSG were measured as L^* , a^* and b^* value respectively. The change in dark colour was due to the incorporation of AP and BSG. L^* value decreased with the increase of addition of AP and BSG. In contrast a^* and b^* values increased with increasing AP and BSG addition respectively. Colour measurement data indicated that samples with addition dietary fibers (AP and BSG) were darker. Total colour change (ΔE) and browning index (BI) increased proportionally to dietary fibers addition, with more pronounced change in samples with AP addition.

Keywords: bread, non-enzymatic browning, colour, apple pomace, brewers' spent grain

INTRODUCTION

Dietary fiber (DF) as a class of compounds includes a mixture of plant carbohydrate polymers, both oligosaccharides and polysaccharides, e.g., cellulose, hemicelluloses,

pectic substances, gums, resistant starch, inulin, that may be associated with lignin and other non-carbohydrate components (e.g., polyphenols, waxes, saponins, cutin, phytates, resistant protein) [Lattimer & Haub, 2010; Stear, 1990]. Baked food products are well liked by consumers all over the world. Because of their high consumption, they can potentially be used as carriers of DF. Different plant fiber products are added to various baked food products in order to increase their fiber content. DF is currently considered as a critical ingredient in food products such as baked goods, beverages, meat, confectionery, dairy and pasta. Most frequently, DF are incorporated into bakery products to prolong freshness due to their capacity to retain water. The research and development efforts on value addition and efficient utilization of nutritionally rich agro-industrial residues such as whey, sugar beet pulp, cassava bagasse, apple pomace, citrus waste, coffee pulp/husk, etc. are gaining momentum around the world.

Apple (*Malus domestica* Borkh.) is probably the oldest fruit known to man and is favoured by millions of people around the globe. In large-scale apple processing industries, the wastes can be categorized into two types. The first type is the fruit discarded into the sorting belt due to its partially bruised/spoiled nature and named as belt rejection. The second type is the apple pomace (AP) obtained after juice extraction. AP is a left-over solid residue (25 – 30 % of the total processed fruits) obtained after the extraction of apple juice. AP is also used for extraction of DF, xyloglucan, natural antioxidant and aromatic compounds. The apple fruit is highly nutritious and contains carbohydrates, proteins, minerals and natural antioxidants. A number of fiber enriched bakery products were prepared by adding dried AP powder on a wheat flour replacement basis. A chemical analysis of the finished product showed that the bakery products prepared by adding apple fibers had a higher dietary fiber content than other sources. Currently, the primary usage of apple pomace is livestock feed. Some efforts have been made for increasing the value added usage of apple pomace, such as producing pectin and adding in different types of bakery products. Apple pomace flour (APF) or wet apple pomace (WAP) can partially substitute wheat flour or meat in bakery or meat products, respectively to enhance dietary fiber and bioactive compounds in the products. This innovative approach to create functional food items could not only increase the value of the by-product from apple juice processing, but also allows commonly consumed products with enhanced health benefits [Sudha, Baskaran & Leelavathi, 2007].

Brewers' spent grain (BSG) is the major by-product of the brewing industry, representing around 85 % of the total by-products. BSG is a cheap source of total dietary fiber that could be used as a functional ingredient in different food products and has great potential to be used as a functional ingredient that may provide beneficial effects on human health. BSG is a good source of protein and has been reported to contain about 17 % cellulose, 28 % noncellulosic polysaccharides, chiefly arabinoxylans and 28 % lignin. Because of the relatively low cost and high nutritional value, BSG has been used in the production of flakes, whole wheat bread, biscuits and aperitif snacks. Although the flour prepared from BSG has been successfully incorporated into a number of bakery products. By incorporating BSG up to 15 % in bread-making technology, the level of dietary fiber will increase up to fivefold. Loaf volume, texture, sensory characteristics and shelf life of BSG

can be improved using appropriate enzymes and forming sourdough. There are still some limitations in the application of BSG as food additives or as a replacement of the present flours, such as its dark colour and flavour. To control the changes in the flavour and physical properties (e.g., texture) of the final products, only relatively small quantities (5 ~ 15 %) of BSG can be incorporated [Mussatto *et al*, 2006].

The present work investigates the effect of some DF from different origins (apple pomace, brewers' spent grain) on the bread colour (crust and crumb) during baking.

MATERIALS AND METHODS

Bread sample preparation and baking

Three different amounts (5, 10 and 15 %) of AP and BSG were incorporated in the bread based on our preliminary studies by considering the minimal impact on the appearance, colour and texture of the products. Baking was carried out in a convection electric oven at 210 °C during 7, 14 and 21 min.

Colour

Surface browning of bread crust samples was measured using colorimeter (Minolta, Model CR-400, Konica Minolta Holdings Tokyo, Japan) and expressed as colour difference ΔE and browning indeks (BI) between the raw dough and the samples subjected to heating according to the following equation.

$$\Delta E = \sqrt{\Delta L^2 + \Delta a^2 + \Delta b^2} \quad (1)$$

where: ΔL = brightness difference; Δa = redness difference; Δb = yellowness difference

$$BI = \frac{100 \cdot (x - 0.31)}{0.17} \quad (2)$$

$$x = \frac{a_t + 1.75 \cdot L_t}{5.645 \cdot L_t + a_0 - 3.012 \cdot b_t} \quad (3)$$

Where a_0 is the initial colour measurement of raw bread of the dough of the crust and L_t , a_t and b_t are the colour measurements at the specific baking time.

Results were expressed in the CIELab colour space and were obtained using the D65 standard illuminant and the 2° standard observer (CIE 1931). The L^* value gives a measure of the lightness of the product colour from 100 for perfect white to 0 for black. The redness/greenness and yellowness/blueness are denoted by a^* and b^* values, respectively. Colorimeter should be calibrated using white boards before measurement. Five replications were performed for each experiment. Averaged results are presented.

RESULTS AND DISCUSSION

The effect of fiber addition (AP and BSG) on the bread colour is summarised in Tables 1- 2 and Figures 1 - 8. Lightness, redness and yellowness of bread samples fortified with different percentages of AP and BSG were measured as L^* , a^* and b^* value respectively (Tables 1 and 2). Significant differences between the crust and crumb of the control bread and the bread obtained with enriched dough were observed.

In terms of crust colour, the control bread gave higher L^* values compared to the breads enriched with fibers from AP and BSG. L^* value decreased with the increase of AP and BSG (83.86 in control to 67.51 and 74.04 in bread prepared with the addition of fibers from AP and BSG). In contrast a^* and b^* values increased with increasing AP and BSG content (Tables 1 and 2). This is mainly due to Maillard and caramelization reactions. A darker color is a characteristic of the Maillard reaction, which was attributed to the degree of polymerization and the presence of low molecular weight sugars in the formulation and the level of its contribution in the recipe [Juszczak *et al.*, 2012; Peressini & Sensidoni, 2009]. In crumb colour values, L^* values decrease and changed from white to black when AP and BSG fibres addition level increase. This crumb lightness reduction could be related to the effect of this fibers source on crumb moisture content (greater moisture, lower lightness). Moreover, the increase in level of fibers added increased crumb a^* values of breads enriched by fibers from AP and BSG and b^* values for breads enriched by fibers from AP. As for breads enriched by fibers from BSG, there was no significant difference for the b^* values.

The largest colour change (ΔE) of AP fortified breads in comparison with BSG fortified breads and non-fortified one was found in 15 % AP fortification (Figure 1 - 4). These colour changes could be due to one or both of the following reasons. First, the original colour (light brown) of AP was much darker than that of wheat flour, which could translate into a darker brown colour in the final baked product. Secondly, apple pomace had higher level of sugar compared with wheat flour, allowing for the increased caramelization and Maillard reaction during baking. Maillard reaction, a nonenzymatic browning reaction between amino acids and reducing sugars is the primary colour formation reaction. BSG caused an increase in the amount of amino acid in the bread samples. Thus, the Maillard browning reaction occurred easily with the increase of BSG leading to a decrease of L^* value and increase of a^* value.

Table 1. Colour measurement data (CIELab) of bread *crust* fortified with different percentages of apple pomace (AP) or brewers' spent grain (BSG) and from control samples (those without AP or BSG)

Level of DF substitution	Baking time [min]	<i>L</i> *	<i>a</i> *	<i>b</i> *
control	0	83.86	-1.13	19.68
	7	79.11	-0.83	22.26
	14	72.57	4.16	33.66
	21	65.51	10.07	37.73
5 % BSG	0	74.04	1.99	15.49
	7	67.14	3.14	17.59
	14	66.95	3.53	20.27
	21	65.09	4.38	22.78
10 % BSG	0	70.09	2.93	15.88
	7	71.22	3.07	21.49
	14	59.50	6.30	22.53
	21	56.48	6.47	25.00
15 % BSG	0	68.11	3.61	16.21
	7	59.79	4.63	19.45
	14	65.60	7.82	28.62
	21	61.11	10.59	30.17
5 % AP	0	67.51	5.38	22.96
	7	54.89	11.34	24.87
	14	51.38	12.10	25.10
	21	49.83	12.19	27.47
10 % AP	0	64.65	6.13	18.31
	7	47.47	11.13	18.59
	14	44.61	11.78	22.52
	21	44.05	12.49	25.23
15 % AP	0	60.64	7.84	9.44
	7	40.96	8.18	10.80
	14	38.22	8.91	15.15
	21	36.68	10.66	27.56

Table 2. Colour measurement data (CIELab) of bread *crumb* fortified with different percentages of apple pomace (AP) or brewers' spent grain (BSG) and from control samples (those without AP or BSG)

Level of DF substitution	Baking time [min]	L*	a*	b*
Control	0	83.86	-1.69	16.54
	7	77.37	-1.66	16.75
	14	75.94	-1.27	17.72
	21	75.26	-0.83	19.68
5 % BSG	0	74.04	0.96	15.00
	7	70.82	1.17	15.37
	14	69.57	1.47	15.49
	21	69.42	1.99	15.63
10 % BSG	0	70.09	2.36	14.96
	7	65.24	2.38	15.16
	14	62.77	2.69	15.88
	21	61.99	3.07	15.92
15 % BSG	0	68.11	3.19	15.88
	7	58.76	3.39	16.21
	14	57.36	3.60	16.24
	21	56.54	3.61	16.34
5 % AP	0	67.51	5.34	23.01
	7	61.85	5.38	23.74
	14	55.11	8.00	25.10
	21	49.11	8.36	26.02
10 % AP	0	64.65	6.13	20.19
	7	57.47	6.97	24.39
	14	47.39	10.35	24.59
	21	41.26	10.66	25.23
15 % AP	0	60.64	7.84	16.00
	7	51.80	8.42	20.30
	14	40.72	9.42	25.12
	21	35.77	10.23	27.56

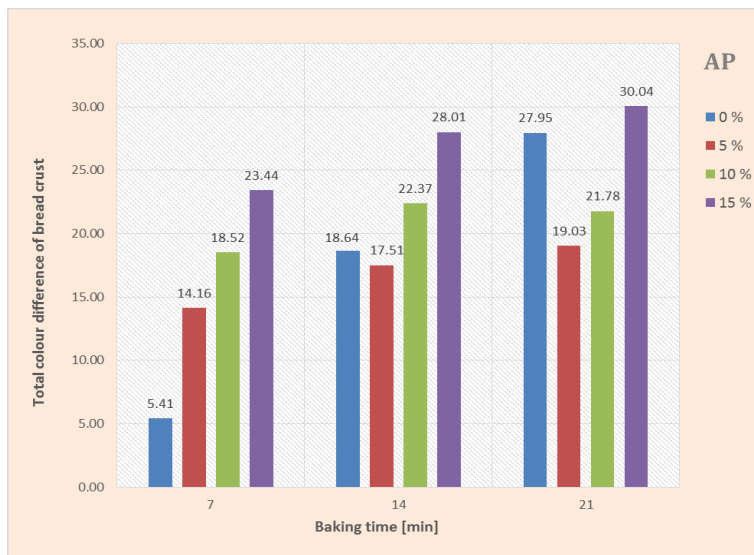

Figure 1. Total colour difference (ΔE) of bread *crust* fortified with different percentages of apple pomace (AP) and control samples (those without AP)

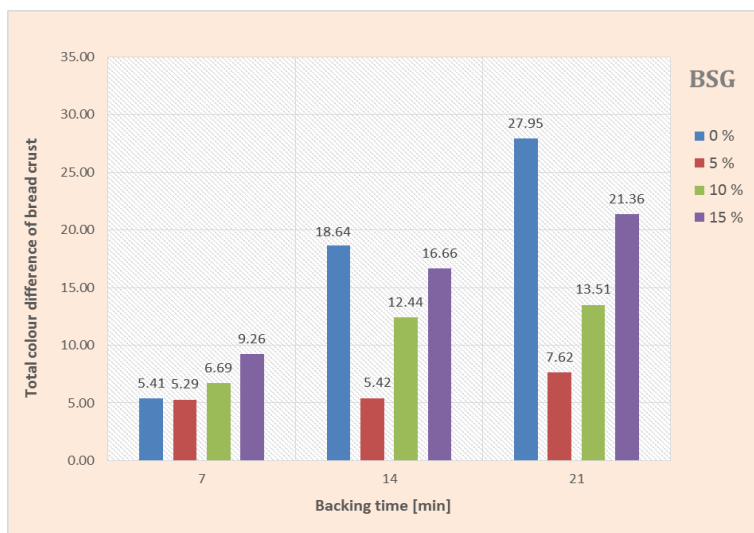

Figure 2. Total colour difference (ΔE) of bread *crust* fortified with different percentages of brewers' spent grain (BSG) and control samples (those without BSG)

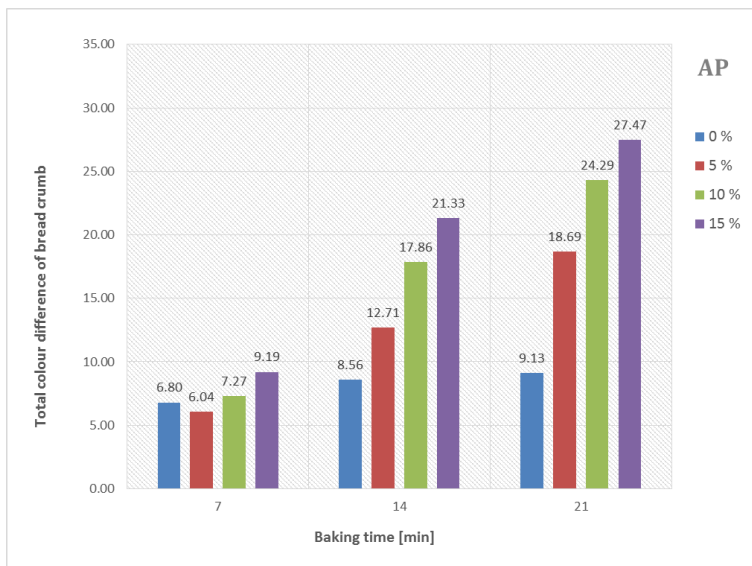

Figure 3. Total colour difference (ΔE) of bread *crumb* fortified with different percentages of apple pomace (AP) and control samples (those without AP)

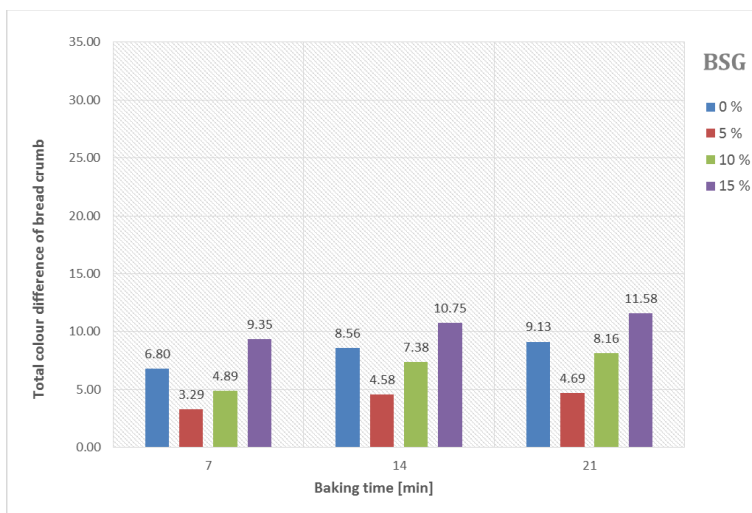

Figure 4. Total colour difference (ΔE) of bread *crumb* fortified with different percentages of brewers' spent grain (BSG) and control samples (those without BSG)

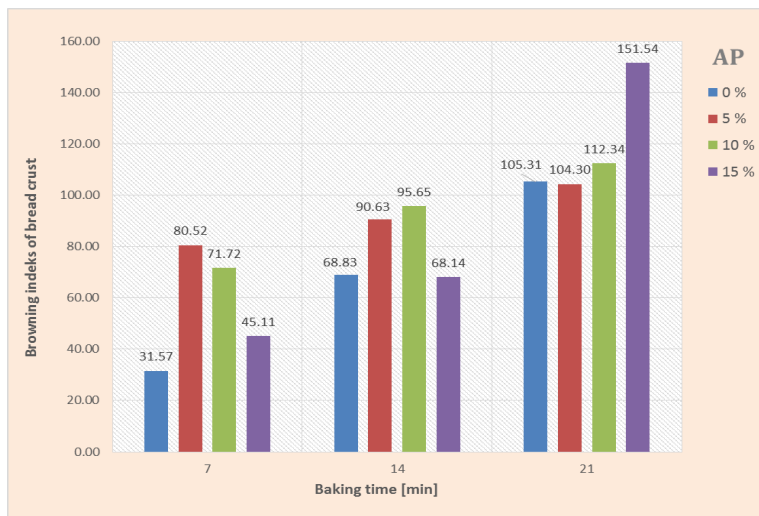

Figure 5. Browning index (BI) of bread *crust* fortified with different percentages of apple pomace (AP) and control samples (those without AP)

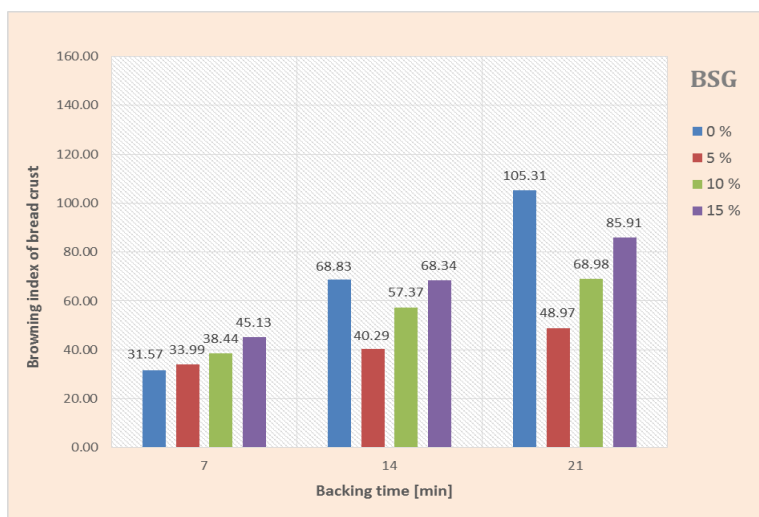

Figure 6. Browning index (BI) of bread *crust* fortified with different percentages of brewers' spent grain (BSG) and control samples (those without BSG)

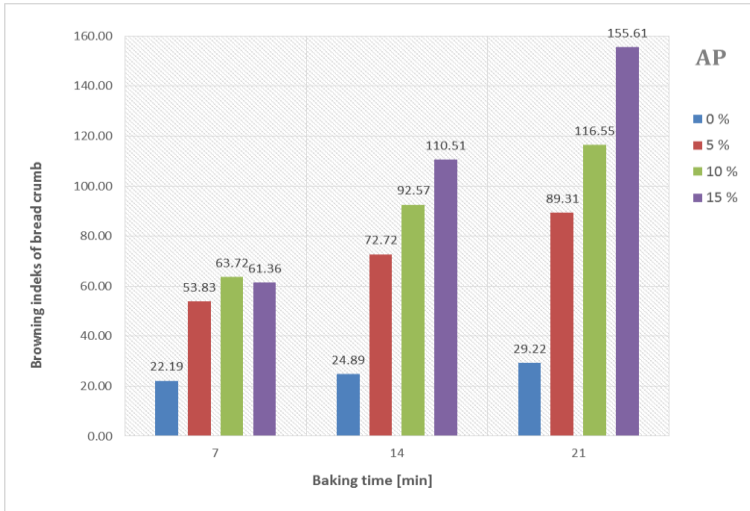

Figure 7. Browning index (BI) of bread *crumb* fortified with different percentages of apple pomace (AP) and control samples (those without AP)

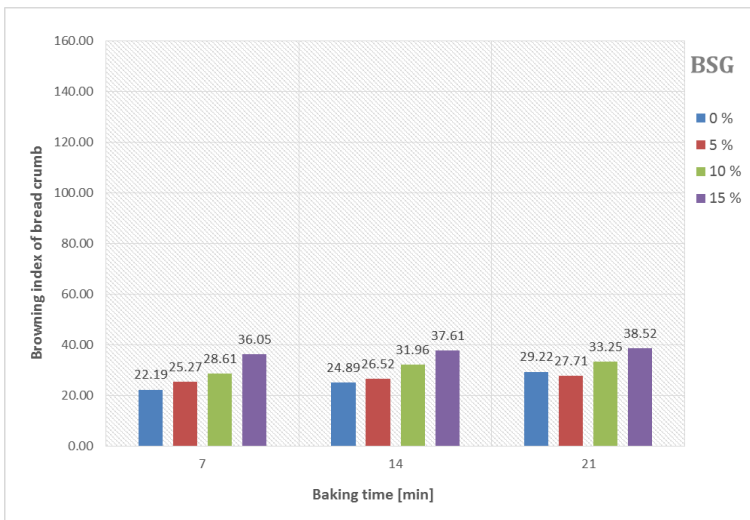

Figure 8. Browning index (BI) of bread *crumb* fortified with different percentages of brewers' spent grain (BSG) and control samples (those without BSG)

CONCLUSIONS

An important difference in bread crust colour was observed only when AP and BSG were used. This difference was related to the low lightness L^* in comparison with the control samples as consequence of its darker colour. However, bread samples fortified with BSG baked 14 and 21 min were lighter (lower ΔE , and BI values) than the control. Bread samples fortified with AP were significantly darker (possessed a lower L^* value; higher ΔE , and BI values) than non-fortified ones (control), and this trend became more marked with increasing percentages of DF. The colour difference, ΔE (taking the control bread colour as reference) shows the influence of fiber additions on the bread colour. Although the original colour of ingredients can have some influence on the crust bread colour this is mainly associated to Maillard and caramelization reactions. The crumb bread colour is usually similar to the colour of the ingredients because the crumb does not reach as high temperatures as the crust. In conclusion, fibres from AP and BSG could be recommended as improver in the bread making industry. AP also has the potential for use in bread making as a good source of polyphenols, which has antioxidant properties.

ACKNOWLEDGEMENTS

This work has been fully supported by Croatian Science Foundation under the project 1321.

REFERENCES

- Juszczak, L., Witzcak, T., Ziobro, R., Korus, J., Cieřlik, E., Witzcak, M. (2012). Effect of 911 inulin on rheological and thermal properties of gluten-free dough. *Carbohydrate Polymers*, 90, 353–360.
- Lattimer, J.M., & Haub, M.D. (2010). Effects of dietary fibre and its components on metabolic health. *Nutrients*, 2, 1266-1289
- Mussatto, S.I., Dragone, G., Roberto, I.C. (2006). Brewers' spent grain: generation, characteristics and potential applications. *Journal of Cereal Science*, 43, 1, 1–14.
- Peressini, D., Sensidoni, A. (2009). Effect of soluble dietary fibre on rheological and 973 bread making properties of wheat doughs. *Journal of Cereal Science*, 49, 190–201.
- Stear, C. A. (1990). Formulation and processing techniques for specialty- bread. In C. A. Stear (Ed.), *Handbook of breadmaking technology*. London: Elsevier Science.
- Sudha, M.L., Baskaran, V., & Leelavathi, K. (2007). Apple pod as a source of dietary fibre and polyphenols and its effect on the rheological characteristics and cake making. *Food Chemistry*, 104, 686–692.

IMPACT OF WHEAT AND BY-PRODUCTS OF FOOD INDUSTRY ON THE BISCUITS PROPERTIES

UDC 664.64.016 : 664.681

Dijana Miličević^{1}, Gordan Avdić¹, Maida Selmić², Edina Hadžiomerović¹,
Martina Andrejaš¹, Selma Mujdanović¹*

¹*University of Tuzla, Faculty of Technology, Univerzitetska 8, Tuzla, Bosnia and Herzegovina*

^{*}*Corresponding author: dijana.milicevic@untz.ba*

²*Factory "Pharmamed" d.o.o. Travnik, Dolac na Lašvi, Bosnia and Herzegovina*

ABSTRACT

The properties of the flour, and therefore the products that will make of it, in great part depend of wheat properties that flour were obtained. This primarily means to the amount of protein, water, and granulation when it comes to meal. For most types of biscuit, flour does not need to have large amount of protein, the amount can be up to 8 or 9 %, except for some types of fermented dough cakes. Due to poor nutritional value, wheat flour can be enriched with other flour types, as well as additives for improving organoleptic properties of biscuits. Apple pomace, sugar beet pulp and brewer's spent grain are by-products of the food industry that have great potential for use in the manufacture of various biscuits types, snack products, etc.

This paper presents the results of production of biscuits from four varieties of wheat flour with added apple pomace, sugar beet pulp and brewer's spent grain in differed proportions. Also, the analysis of raw materials was performed, as well as the sensory analysis of biscuit products.

Keywords: wheat flour, byproducts of food industry, biscuits

INTRODUCTION

By-products of food industry have an increasingly important role in the production of various products, such as snack products, especially cookies. Apple pomace, sugar beet pulp and brewer's spent grain can be mixed with corn meal and extruded flour and as such are an important source of fiber, vitamins and other nutritionally important substances to improve the properties of final products.

Extrusion is one of the most prospective methods that are increasingly used in the food industry in order to improve or modify the properties of the raw materials or semi-finished food products.

In this investigation, biscuits are made from flour of different quality groups originating from four varieties of wheat. Biscuits were also made from wheat flour with added

mixtures of sugar beet pulp and corn meal, apple pomace and corn meal and brewer's spent grain and corn meal, which was extruded previously. Raw materials was analysed for basic chemical composition, and biscuits were sensoric estimated.

MATERIALS AND METHODS

Materials: flour from wheat "Kraljica", "Srpanjka", "Felix" and "Leuta", extruded mix of corn meal whit brewer's spent grain, corn meal whit apple pomace and corn meal whit sugar beet pulp, backin', eggs, sugar, butter and vanilla sugar.

Methods: determining the amount of dry matter (water), determining the degree of acidity and determination of water absorption and biscuits preparation from raw materials.

RESULTS AND DISCUSSION

Table 1. Results of chemical, extensiograph and farinograph analysis of wheat flour

CHEMICAL QUALITY PARAMETERS	SRPANJKA	KRALJICA	FELIX	LEUTA
Proteins (%)	12.1	13.8	12.3	10
Value of sediment (cm ³)	37	54	48	34
Number of falling (sec)	315	378	365	377
Wet gluten (%)	22.7	27	25.4	21.5
Gluten index	100	97	97	96
EKSTENSOGRAPHIC PARAMETERS				
Energy (cm ²)	75	81	90	91
Resistance (EJ)	284	232	309	296
Extensibility (mm)	144	168	153	157
Maximaly Resistance (EJ)	404	386	464	458
Resistance /Extensibility	2.0	1.4	2.0	1.9
Flour extraction (%)	74	74	69	72
FARINOGRAPHIC PARAMETERS				
Water absorbance (%)	56.7	58.8	59.1	57.1
Development (min.)	2.1	10.9	1.9	1.7
Stability (min.)	0.2	3.4	0.7	0.3
Resistance (min.)	2.3	14.3	2.6	2.0
Softening degree (FJ)	57	0	30	82
Farinograph quality number (FBK)	33	200	66	31
Quality group	B1	A1	A2	B2

Results of chemical analysis of flour from all four wheat varieties showed possibility of using flour for production of different bakery products and different varieties of biscuits. In particular, it shows the amount of protein ranging in an appropriate range. Thus, for the production of biscuits, the most suitable variety of wheat is Leuta because it has the least amount of protein, which is appropriate for most types of biscuits. However, other varieties of wheat, which were also tested, can be used for bread production and other products made from yeast dough that require a larger amount of protein but also can be used to produce some types of biscuits. Extensograph and pharinograph quality parameters generally are appropriate for the purpose and flour can be used for the production of biscuits.

Table 2. Results of basic chemical analysis for flour and mixtures of wheat flour and extruded mix corn meal with apple pomace, sugar beet pulp and brewer's spent grain

Sample	Water content (%)	Degree of acidity (%)	Water absorption (%)
1 Kraljica	12.08	1.1	51.41
2 Srpanjka	9.71	1.4	51.68
3 Felix	11.56	1.5	50.89
4 Leuta	9.75	1.1	50.89
5 K/CM/AP 80:20	9.97	1.1	50.28
6 K/CM/AP 90:10	11.88	1.5	54.56
9 K/CM/SBP 80:20	11.72	1.7	51.82
10 K/CM/SBP 90:10	12.16	1.3	50.89
11 S/CM/AP 80:20	11.78	1.1	54.32
12 S/CM/AP 90:10	12.87	1.1	53.78
15 S/CM/SBP 80:20	10.81	1.8	51.67
16 S/CM/SBP 90:10	11.06	1.7	51.81
17 F/CM/AP 80:20	9.09	1.0	53.2
18 F/CM/AP 90:10	9.18	1.4	53.63
21 F/CM/BSG 80:20	11.55	1.5	54.05
22 F/CM/BSG 90:10	11.82	1.1	52.91
23 L/CM/AP 80:20	13.35	1.7	54.06
24 L/CM/AP 90:10	14.29	0.9	52.91
27 L/CM/BSG 80:20	11.2	1.5	54.49
28 L/CM/BSG 90:10	11.51	1.3	53.91

K-Kraljica, S-Srpanjka, F-Felix, L-Leuta, CM-corn meal, AP-apple pomace, SBP-sugar beet pulp, BSG-brewer's spent grain

Tables 3, 4, 5, 6 and 7 shows the results of the sensory analysis for biscuits made from all types of flour and mixtures thereof. Sensory analysis were evaluated for following properties of biscuits: shape, color, surface; strength, structure, chewing properties; smell and taste.

Table 3. Results of sensory analysis for biscuits made from wheat flour (Kraljica, Srpanjka, Felix, Leuta)

Sample	1 Kraljica	2 Srpanjka	3 Felix	4 Leuta
Shape, color, surface	2.0	1.96	1.84	1.88
Strength, structure	4.6	4.4	4.5	4.1
Chewing properties	4.3	3.8	4.4	3.9
Smell	3.76	3.92	4.0	3.92
Taste	3.68	3.76	3.6	3.76
Sum	18.34	17.84	18.34	17.56

Table 4. Results of sensory analysis for biscuits made from flour and extruded mix corn meal and apple pomace (80:20)

Sample	5 K/CM/AP 80:20	11 S/CM/AP 80:20	17 F/CM/AP 80:20	23 L/CM/AP 80:20
Shape, color, surface	1.96	1.96	2.0	1.82
Strength, structure	4.9	4.7	5.0	4.0
Chewing properties	4.5	4.6	4.9	4.1
Smell	4.0	3.92	3.92	3.92
Taste	4.0	3.92	3.92	3.84
Sum	19.36	19.1	19.74	17.68

Table 5. Results sensoric analysis for biscuits made from flour and extruded mix corn meal and apple pomace (90:10)

Sample	6 K/CM/AP 90:10	12 S/CM/AP 90:10	18 F/CM/AP 90:10	24 L/CM/AP 90:10
Shape, color, surface	1.84	1.96	2.0	1.96
Strength, structure	4.9	4.6	4.8	4.2
Chewing properties	5.0	4.7	4.6	4.3
Smell	4.0	3.68	3.92	3.92
Taste	4.0	3.86	4.0	3.84
Sum	19.74	18.8	19.32	18.22

Table 6. Results of sensory analysis for biscuits made from flour and extruded mix corn meal and sugar beet pulp (80:20 and 90:10)

Sample	9 K/CM/SBP	10 K/CM/SBP	15 S/CM/SBP	16 S/CM/SBP
	80:20	90:10	80:20	90:10
Shape, color, surface	1.88	1.88	2.0	1.96
Strength, structure	4.2	4.3	4.4	4.4
Chewing properties	4.3	4.3	4.5	4.2
Smell	4.0	4.0	3.84	3.92
Taste	3.72	3.72	4.0	3.92
Sum	18.1	18.2	18.74	18.4

Table 7. Results of sensory analysis for biscuits made from flour and extruded mix corn meal and brewer's spent grain (80:20 and 90:10)

Sample	21 F/CM/BT	22 F/CM/BT	27 L/CM/BT	28 L/CM/BT
	80:20	90:10	80:20	90:10
Shape, color, surface	1.96	2	1.96	2
Strength, structure	4.3	4.4	5	5
Chewing properties	4.2	4.6	4.9	4.9
Smell	3.76	3.92	3.84	3.84
Taste	3.84	3.76	3.92	3.92
Sum	18.06	18.68	19.62	19.66

CONCLUSIONS

Flour of all four tested varieties of wheat can be used to produce different types of biscuits regarding the amount of protein. Farinograph analysis showed that the flour of tested wheat varieties belong to the following groups of quality: Kraljica A1, Felix A2, Srpanjka B1 and Leuta B2. Top rated biscuits without the addition of extruded mixtures are those made from wheat flour Kraljica and Felix.

The least assessed biscuits without the addition of extruded mixtures are those made from Leuta wheat flour. All biscuits made of flour of wheat varieties were given a smaller number of points in relation to the biscuits with additives. Added extruded mixtures have improved almost all studied organoleptic properties.

Biscuits with the addition of apple pomace had the most points in three cases (Kraljica, Srpanjka, Felix). Only in one case (Leuta) had the highest score of biscuits with the addition of brewers' spent grain.

Individual sensory characteristics in terms of ratings were generally consistent when it comes to smell, taste, shape and color of the surface. The largest differences in the scores were in the assessment of strength, structure and chewing properties.

At the end, it could be concluded that extruded mixture of corn meal with brewer's spent grain, sugar beet pulp and apple pomace could be used for the production of biscuits.

Biscuits that are obtained is of satisfactory quality, but one should take into account the amount of added supplement because of the impact on the sensory properties of biscuits.

ACKNOWLEDGEMENTS

This work has been supported in part by Croatian Science Foundation under the project 1321.

REFERENCES

- Bešlagić, S. (1999): Tehnologija prerade žita, škroba i šećera, IP Svjetlost, Sarajevo.
- Cauvain, S.P., Young, L.S. (2006): Baked products: Science, technology and practice, Blackwell publishing.
- Ćurić, D., Novotni, D., Tušak, D., Bauman, I., Gabrić, D. (2007); Gluten-Free Bread Production by the Corn Meal and Soybean Flour Extruded Blend Usage, *Agriculturae Conspectus Scientificus* | Vol. 72 No. 3, 227-232
- Đaković, Lj. (1997): Pšenično brašno, Novi sad.
- Edwards, W. P. (2007): The Science of Bakery Products, The Royal Society of Chemistry, Cambridge, UK
- Figoni, P. (2008): How baking works, Exploring the Fundamentals of Baking Science, 2nd edition, John Wiley & sons, inc. New Jersey
- Gülüm, S.S., Sahin, S. (ed)(2008): Food Engineering Aspects of Baking Sweet Goods, Taylor & Francis Group, LLC, CRC Press
- Hui, Y. H. (ed) (2006): Bakery Products, Science and Technology, Blackwell Publishing.
- Kaluđerski, G., Filipović, N. (1998): Metode ispitivanja kvaliteta žita, brašna i gotovih proizvoda, Tehnološki fakultet Univerziteta u Novom Sadu, Novi Sad
- Kljusurić, S. (2000): Uvod u tehnologiju mljevenja pšenice, Prehrambeno tehnološki fakultet Sveučilišta Josip Juraj Strossmayer, Osijek
- Kovačević, M. B. (1991): Savremeno pekarstvo, Cvetnik, Novi Sad
- Mandić, M. (2006): Osnove senzorske procjene hrane, Prehrambeno-tehnološki fakultet Osijek
- Miličević, D. (2011): Tehnologija pekarskih i pekarsko-konditorskih proizvoda, JU Opća biblioteka, Maglaj
- Pravilnik o keksima i keksima srodnim proizvodima, Narodne novine, 2005

Pravilnik o kvalitetu žita, mlinskih i pekarskih proizvoda, tjestenina i brzo smrznutih tijesta, "Službeni list SFRJ" , br. 53/83

Radovanović, R., Popov-Raljić, J. (2000/2001): Senzorna analiza prehrambenih proizvoda, Poljoprivredni fakultet Beograd, Tehnološki fakultet Novi Sad

Sumnu, S.G., Sahin, S., (ed) (2008): Food engineering aspects of baking sweet goods, CRC Press, Taylor and Francis group.

Trajković, J., Mirić, M., Baras, J., Šiler, S. (1983): Analize životnih namirnica, Tehnološko-metalurški fakultet Univerziteta u Beogradu, Beogra

Žeželj, M. (1995): Tehnologija žita i brašna, knjiga 1, Tehnološki fakultet u N.Sadu Zavod za tehnologiju žita, Novi Sad

Žeželj, M. (2005): Tehnologija žita i brašna, knjiga 2, NIP Glas javnosti, Beograd

http://www.fsa.gov.ba/fsa/images/pravni-propisi/hr-Pravilnik_o_keksima_i_proizvodima_srodnim_keksima_51-11.pdf

http://www.agrif.bg.ac.rs/files/subjectfiles/177/5-%20Uvod_u_tehnologiju_keksa_i_proizvoda_srodnih_keksu.pdf

<https://www.scribd.com/doc/206147295/keksarstvo>

<http://www.agrif.bg.ac.rs/files/subjectfiles/191/8-SENZORNA-ANALIZA.pdf>

PREDICTING THE TEXTURE OF COOKED PASTA BASED ON MECHANICAL PROPERTIES OF DRIED PASTA

UDC 664.641.2 + 664.69

Dubravka Jambrec, Mladenka Pestorić, Olivera Šimurina, Bojana Filipčev, Nataša Nedeljković, Marijana Sakač, Anamarija Mandić*

*Institute of Food Technology, University of Novi Sad,
Bulevar cara Lazara 1, 21000 Novi Sad, Serbia*

**Corresponding author: dubravka.jambrec@fins.uns.ac.rs*

ABSTRACT

Going up with demands of modern consumers in addition to traditionally produced pasta, there is plenty of non traditional pasta made from multigrain flours of different cereals and pseudocereals. All these modifications in pasta formulation cause changes in textural properties which are one of the most important properties of pasta quality.

The aim of this study was to develop a model for predicting the texture of cooked pasta by measuring mechanical properties of dried pasta. Textural properties of whole grain pasta with added different levels (0-30 %) of buckwheat flour were measured by a texture analyser (TA.XTPlus). Hardness and brittleness were measured with Ottawa cell. Firmness of the cooked pasta was determined applying the AACC (16-50) method. Correlation analysis was performed to establish the significance and the degree of linear association between two variables at $p < 0.05$. Coefficients of variation (r^2) were calculated, as well. There was a very high significant correlation between hardness and firmness ($r = 0.96985$, $r^2 = 0.9406$), and high but not significant correlation between brittleness and firmness ($r = 0.92639$, $r^2 = 0.8582$). Coefficients of variation indicated that the variability noted in cooked pasta textural properties in a great extent can be explained by mechanical properties of dried pasta.

Keywords: pasta, texture, buckwheat, hardness, firmness

INTRODUCTION

Historically, pasta was made from semolina, the coarsely grounded endosperm of durum wheat which was processed into dough by adding water, extruding the dough into desired shape and drying pasta under well controlled conditions. In recent years, pasta manufacturers have been faced with growing consumers' demands towards nutritionally and functionally richer foods. So far, many studies have attempted to provide responses to the consumers' demands changing the pasta formulation by substituting, partially or completely, durum wheat semolina with whole wheat flour and multigrain flours of different cereals and pseudocereals (Chillo *et al.*, 2008; Fares *et al.*, 2010; Gallegos-Infante *et al.*, 2010; Lamacchia *et al.*, 2011; Petitot *et al.*, 2010; Wood, 2009). Beside these, there is an

enlarged number of papers on the possibility of preparing gluten-free pasta (Lucisano *et al.*, 2012; Marti *et al.*, 2010; Marti *et al.*, 2013; Verardo *et al.*, 2011).

Among potential pseudocereals, buckwheat is one of the best plant sources of proteins, minerals, antioxidants and dietary fibres (Sedej *et al.*, 2011). Furthermore, it does not contain gluten which makes it a good choice for incorporation into the gluten-free pasta formulation. Antioxidant components in buckwheat, such as flavonoids, phenolic acids, tannins, phytosterols and tocopherols play an important role as anti-inflammatory and anticarcinogenic agents (Kreft *et al.*, 2006; Lin *et al.*, 2009).

Pasta is popular food because of its sensory attractiveness which is determined by texture, appearance and flavour. Out of these three, textural properties have received more research effort because of their importance to consumer acceptance (D'Egidio *et al.*, 1998). The firmness or mechanical strength of dry pasta is considered a standard of quality control because it is closely related to the raw material properties and pasta processing, especially the drying process (Guinea *et al.*, 2004). In addition to this, mechanical measurements are very convenient since they are simple and can be easily integrated in the production plant and provide useful information for the design of packaging and shipping operations. However, all modifications in traditional pasta formulation cause changes in textural properties and thus affect pasta quality. Measurements of mechanical and textural properties enable maintaining consistency and quality of pasta.

Texture can be assessed in many ways by both, human senses and instruments. Sensory analysis using highly trained panellists is time consuming and impractical when sample size is limited or costly when large number of samples have to be evaluated. On the other hand, instrumental techniques are quick, repeatable and mostly do not require a large amount of samples. Various instrumental techniques have been developed for the evaluation of pasta texture. However, many of them are related to the evaluation of cooked pasta texture, but only a few for testing dry pasta texture, wherein all are adapted for the determination of spaghetti texture. Challenges exist when trying to measure texture of differently shaped pastas.

In this study we investigated the influence of formulation changes on mechanical and textural properties of buckwheat containing whole grain pasta. Furthermore, we examined whether the selected compression tests for measurements of dry pasta mechanical properties and cooked pasta textural properties can measure the differences that occur due to changes in formulation. The next goal was to examine the possibility of using mechanical properties measurements for prediction of cooked pasta firmness.

MATERIALS AND METHODS

Tagliatelle production

Four types of tagliatelle were produced on an industrial scale using Ital past Mac 60 (Parma, Italy). The control sample was made of commercial wholegrain wheat flour. Buckwheat pasta was produced by substitution of wholegrain wheat flour with wholegrain buckwheat flour at the substitution levels of 10, 20, and 30 % (used labels

10WB, 20WB, and 30WB). Flour of certain formulation was hydrated with deionised water in order to achieve proper dough consistency for extrusion.

Tagliatelle cooking

All tagliatelle samples (100 g) were cooked according to (AACC, 1995) in 1 L of boiling and salted (5 g NaCl) tap water until optimum cooking time (OCT) was reached. To determine OCT at least three tagliatelle were removed from the cooking water at 15 s intervals and pressed between two plexiglass plates. The OCT was defined as the time required for the white core in the centre of the sample to disappear.

Dry and cooked tagliatelle physical properties

Dry tagliatelle width, thickness and length as well as cooked tagliatelle thickness were measured using nonius (Table 1). Moisture content was determined according to the AOAC methods (1984) (Table 1).

Textural properties of tagliatelle

A texture analyser (TA.XT Plus, Exponent Stable Micro System, UK) together with specific software (Texture Exponent TEE32 6.1.1.0, Stable Micro System, UK) was used for measuring tagliatelle textural properties. Measurements on dry tagliatelle were run with 50 kg load cell while measurements on cooked tagliatelle were run with 30 kg load cell.

Ottawa Cell with 17-bladed Extrusion Plate was used for measurements of mechanical properties (hardness and brittleness) of dry tagliatelle. This attachment was fixed onto the machine base. Test settings were as follows: Option: Return to start; Test speed: 5.0 mm/s; Post-test speed: 10 mm/s; Distance: 60 mm. The maximum peak force from the force-distance graph was considered to be an indication of overall 'hardness' of the pasta samples and the linear distance was considered as an indication of 'brittleness'. About 30 g of pasta sample was placed in the cell. Firmness of cooked tagliatelle was tested in time up to 15 min after cooking and at room temperature (~22 °C) applying the AACC (16-50) method. The compression test was performed by a 1 mm flat Perspex Knife Blade (A/LKB-F) on three strips of tagliatelle sample adjacent to one another centrally under the knife blade. The instrumental setting was taken from the sample projects of the software package (Texture Exponent TEE32 6.1.1.0, Stable Micro System, UK) and they were as follows: Option: Return to start; Test speed: 0.17 mm/s; Post-test speed: 10 mm/s; Distance: 4.5 mm. Firmness is defined in this method as the work in grams-centimetre required to shear one piece of pasta. Data reported are means of ten measurements of each sample.

Statistical analysis

For all measurements, results were expressed as the mean of replications \pm SD. Coefficients of variations was calculated as well and used as an indicator of measurement reproducibility. Significance of differences between means was determined by analysis of variance (ANOVA) following with Fisher's Least Significant Difference (LSD) test.

Pearson's correlation coefficients were calculated between mechanical properties of dry and textural properties of cooked tagliatelle samples, and values were compared at $p < 0.05$. All statistical analyses were performed using STATISTICA (StatSoft, Inc. (2011), version 10.0 (www.statsoft.com)).

RESULTS AND DISCUSSION

Many factors may have an impact on mechanical properties of pasta. They can be related with structural properties (compactness of structure, chemical characteristics of ingredients and their particle size, extrusion and drying conditions) and/ or with geometrical properties (shape, diameter, thickness, width) (Mariotti *et al.*, 2011). All produced tagliatelle had statistically the same width, thickness and length, moreover, all tagliatelle, except for the control possessed statistically the same moisture content as well (Table 1). This contributed to minimising the effect of tagliatelle geometrical properties on measurements and made it possible to assume that all observed differences in mechanical and textural properties were the result of tagliatelle formulation.

Table 1. Geometrical properties of dry and cooked tagliatelle samples and moisture content of dry tagliatelle

Samples	Dry tagliatelle				Cooked tagliatelle
	Width (cm)	Thickness (cm)	Length (cm)	Moisture content (%)	Thickness (cm)
Control	0.89 ^a ± 0.05	0.13 ^a ± 0.01	12.80 ^b ± 3.21	9.74 ^b	0.15 ^{ab} ± 0.01
10WB	0.92 ^a ± 0.01	0.13 ^a ± 0.00	9.22 ^a ± 0.84	9.06 ^a	0.16 ^{bc} ± 0.03
20WB	0.92 ^a ± 0.01	0.13 ^a ± 0.00	10.65 ^{ab} ± 2.04	9.05 ^a	0.14 ^a ± 0.02
30WB	0.91 ^a ± 0.01	0.13 ^a ± 0.01	11.58 ^{ab} ± 1.90	9.06 ^a	0.17 ^c ± 0.01

Values are means of ten measurements ± standard deviation.

Values of the same column with the same superscript are not statistically different ($p < 0.05$).

The feasibility of using compression test probe for measurement of mechanical properties (hardness and brittleness) with Ottawa cell has been estimated based on values of the coefficient of variation (Table 2) (Jambrec *et al.*, 2015). The coefficient of variation (CV) is a relative measure of error because it weights the standard deviation for the size of the mean and therefore can be used for the comparison of variation from different methods or scales (Belović *et al.*, 2014). In this study, results were reproducible, CV values were lower than 15 and we reached the conclusion that the Ottawa cell is appropriate for tagliatelle mechanical properties measurements.

Table 2. Mechanical properties (hardness and brittleness) of dry tagliatelle and firmness of cooked tagliatelle

Samples	Ottawa cell		AACC (16-50)
	Hardness (kg)	Brittleness (kg)	Firmness (kg)
Control	38.80 ^a ± 5.51 (14.20)	508.1 ^a ± 30.16 (5.94)	0.473 ^a ± 0.03
10WB	30.86 ^b ± 3.13 (10.15)	432.7 ^b ± 45.28 (10.47)	0.519 ^{bc} ± 0.04
20WB	27.92 ^b ± 1.91 (10.25)	404.5 ^b ± 35.31 (8.73)	0.558 ^c ± 0.05
30WB	31.55 ^b ± 3.23 (10.25)	421.4 ^b ± 26.80 (6.36)	0.514 ^b ± 0.04

Values are means ± standard deviation.

Values in brackets for mechanical measurements represent coefficients of variation.

Values of the same column with the same superscript are not statistically different ($p < 0.05$).

Based on the obtained results for mechanical properties (Table 2), buckwheat flour addition to the pasta formulation decreased dry tagliatelle hardness and brittleness. The results are in accordance with Wójtowicz *et al.* (2011) who showed that hardness of dry pasta samples, evaluated with the cutting test, decreased with increasing bran content in the pasta recipe. Namely, weakening of tagliatelle structure and lower hardness followed by the increased bran content can be due to the appearance of spoil and/ or empty places nearby fiber parts that make less compact pasta structure. Furthermore, fibrous composition of bran may cause separation of singular fiber during extrusion (Wójtowicz *et al.*, 2011).

While increased content of bran in tagliatelle formulations with whole grain buckwheat flour decreased hardness of dry tagliatelle, the occurrence and distribution of these ingredients in formulation affected an increase in cooked tagliatelle firmness (Table 2). It seems that bran particles from wholegrain flours provided resistance to compression, as previously noticed by Manthey and Dick (2012) as well.

In order to examine the empirical relationship between mechanical properties of dry tagliatelle and textural properties of cooked tagliatelle correlation analysis was applied. Correlation coefficients (r) provided us with the information about both a magnitude and a direction of relationship. Squaring the correlation coefficient we obtained the coefficient of determination (r^2) which explained the percentage of the variation in the values of the examined data set (Taylor, 1990). The value of coefficient of determination provided an insight into how the data are fitted by a linear line and also indicated the predictive ability of the obtained regression equation.

Results indicate that there was very high negative correlation ($r > 0.9$) between mechanical and textural properties of tagliatelle (Fig. 1). Correlation between hardness and firmness ($r = -0.96985$) was statistically significant ($p < 0.05$) and although it was high between brittleness and firmness ($r = -0.92639$), it was not significant. Based on these results it can be concluded that the harder and more brittle dry whole grain buckwheat containing tagliatelle is, the less firm it will get after cooking. Furthermore, coefficients of variation ($r^2 = 0.9406$, between hardness and firmness; $r^2 = 0.8582$, between brittleness and firmness)

confirmed that the variability noted in cooked tagliatelle textural properties can be explained in a great extent by mechanical properties of dried pasta.

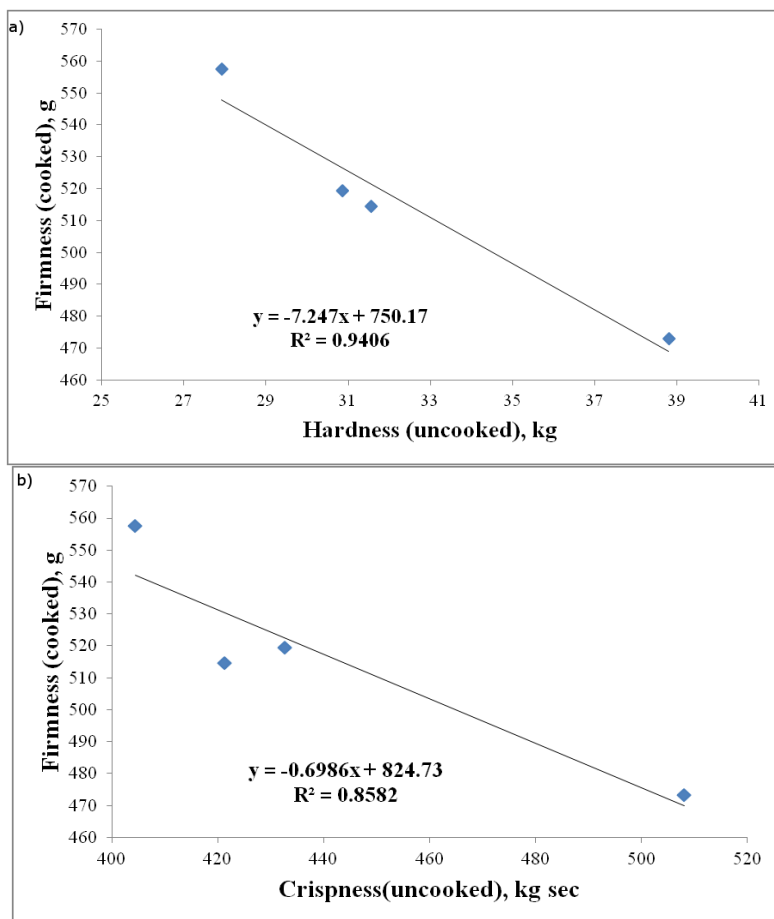

Figure 1. Relationship between mechanical and textural properties of whole grain buckwheat containing tagliatelle: a) correlation between hardness and firmness, b) correlation between brittleness and firmness

CONCLUSIONS

The Ottawa cell was used for measurements of dry tagliatelle mechanical properties. Although the applied attachment is commonly used for the determination of textural properties of cooked pasta, the obtained results indicate that this attachment can be used for the evaluation of dry pastas, as well.

Incorporation of whole grain buckwheat flour into the pasta formulation had a significant ($p < 0.05$) effect on mechanical properties of dry and textural properties of cooked tagliatelle. Specific structure components of whole grain wheat and buckwheat flour caused disruption to pasta internal structure, and with increasing bran content tagliatelle hardness and brittleness was decreased. On the other hand, occurrence of bran from whole grain flour provided resistance to compression making whole grain tagliatelle firmer. Correlation analysis of the obtained data revealed very high correlation between mechanical and textural properties of whole grain tagliatelle and indicates possibility of using mechanical properties for the prediction of textural properties of cooked tagliatelle.

ACKNOWLEDGEMENTS

This work is a part of the Project (TR31029) supported by the Ministry of Science and Technological Development, Republic of Serbia.

REFERENCES

- AACC. Approved Methods of the AACC.1995. 9th ed. The Association: St. Paul, MN.
- AOAC, Official Methods of Analysis (13th ed.), Association of Official Analytical Chemists, Washington, DC, USA, (1980).
- Belović, M., Pestorić, M., Mastilović, J., Kevrešan, Ž. (2014): Changes in carrot texture during cooking, *Journal on Processing and Energy in Agriculture*, 18, 36-39.
- Chillo, S., Laverse, J., Falcone, P. M., Protopapa, A., Del Nobile, M. A. (2008). Influence of the addition of buckwheat flour and durum wheat bran on spaghetti quality. *J Cereal Sci.* 47, 144–152. doi:10.1016/j.jcs.2007.03.004.
- D'Egidio', M. G., Nardi, S. (1998): Textural measurement of cooked spaghetti. In: *Pasta and Noodle Technology* (edited by J. E. Kruger, R. B. Matsuo, J. W. Dick). St Paul, MN, USA: American Association of Cereal Chemistry, pp. 133-156.
- Fares, C., Platani, C., Baiano, A., Menga, V. (2010): Effect of processing and cooking on phenolic acid profile and antioxidant capacity of durum wheat pasta enriched with debranning fractions of wheat, *Food Chem.* 119, 1023-1029. doi:10.1016/j.foodchem.2009.08.006.
- Gallegos-Infante, J. A., Rocha-Guzman, N. E., Gonzales-Laredo, R. F., Ochoa-Martínez, L. A., Corzo, N., Bello-Perez, L. A., Medina-Torres, L., Peralta-Alvarez, L. E. (2010): Quality spaghetti pasta containing Mexican common bean flour (*Phaseolus vulgaris* L.), *Food Chem.* 119, 1544-1549. doi:10.1016/j.foodchem.2009.09.040.
- Guinea, G. V., Rojo, F. J., Elices, M. (2004): Brittle failure of dry spaghetti, *Eng Fail Anal.* 11, 705-714. doi:10.1016/j.engfailanal.2003.10.006.
- Jambrec, D., Šimurina, O., Pestorić, M., Nedeljković, N., Sakač, M., Šarić, B., Mandić, A. (2015): Feasibility of using different attachments for measuring textural properties of dry tagliatelle shaped pasta, *Journal of Processing and Energy in Agriculture.* 19, 31-33.
- Kreft, I., Fabjan, N., and Yasumoto, K. (2006): Rutin content in buckwheat (*Fagopyrum esculentum* Moench) food materials and products, *Food Chem.* 98, 508-512. doi:10.1016/j.foodchem.2005.05.081.

- Lamacchia, C., Baiano, A., Lamparelli, S., Terracone, C., Trani, A., Luccia, A. D. (2011): Polymeric protein formulation during pasta-making with barley and semolina mixtures, and prediction of its effect on cooking behaviour and acceptability, *Food Chem.* 129, 319-328. doi: 10.1016/j.foodchem.2011.04.063.
- Lin, L. Y., Liu, H. M., Yu, Y. W., Lin, S. D., Mau, J. L. (2009): Quality and antioxidant property of buckwheat enhanced wheat bread, *Food Chem.* 112, 987-991. doi:10.1016/j.foodchem.2008.07.022.
- Lucisano, M., Cappa, C., Fongaro, L., Mariotti, M. (2012): Characterisation of gluten-free pasta through conventional and innovative methods: Evaluation of the cooking behaviour, *J Cereal Sci.* 56, 667-675. doi:10.1016/j.jcs.2012.08.014.
- Manthey, F. A., Dick, T. (2012): Assessment of probe type for measuring pasta texture. *Cereal Food World*, 57, 56-62. <http://dx.doi.org/10.1094/CFW-57-2-0056>.
- Mariotti, M., Iametti, S., Cappa, C., Rasmussen, P., Lucisano, M. (2011): Characterisation of gluten-free pasta through conventional and innovative methods: evaluation of the uncooked products, *J Cereal Sci.* 53, 319-327. doi:10.1016/j.jcs.2011.02.001.
- Marti, A., Caramanico, R., Bottega, G., Pagani, M. A. (2013): Cooking behavior of rice pasta: Effect of thermal treatments and extrusion conditions, *LWT - Food Sci Technol.* 54, 229-235. doi:10.1016/j.lwt.2013.05.008.
- Marti, A., Seetharaman, K., Pagani, M. A. (2010): Rice-based pasta: A comparison between conventional pasta-making and extrusion-cooking, *J Cereal Sci.* 52, 404-409. doi:10.1016/j.jcs.2010.07.002.
- Petitot, M., Boyer, L., Minier, C., Micard, V. (2010): Fortification of pasta with split pea and faba bean flours: Pasta processing and quality evaluation, *Food Res Int.* 43, 634-641. doi:10.1016/j.foodres.2009.07.020.
- Sedej, I., Sakač, M., Mandić, A., Mišan, A., Pestorić, M., Šimurina, O., Čanadanović-Brunet, J. (2011): Quality assessment of gluten-free crackers based on buckwheat flour. *LWT - Food Sci Technol.* 44, 694-699. doi:10.1016/j.lwt.2010.11.010.
- Taylor, R. (1990): Interpretation of the correlation coefficient: A basic review, *J Diagn Med Sonog.* 1, 35-39. doi: 10.1177/875647939000600106.
- Verardo, V., Arráez-Román, D., Segura-Carretero, A., Marconi, E., Fernández-Gutiérrez, A., Caboni, M. F. (2011): Determination of free and bound phenolic compounds in buckwheat spaghetti by RP-HPLC-ESI-TOF-MS: Effect of thermal processing from farm to fork, *J Agr Food Chem*, 59, 7700-7707. doi: 10.1021/jf201069k.
- Wójtowicz, A., Mościcki, L. (2011): Effect of wheat bran addition and screw speed on microstructure and textural characteristics of common wheat precooked pasta-like products, *Pol J Food Nutr Sci.* 61, 101-107. doi: 10.2478/v10222-011-0010-z.
- Wood, J. A. (2009): Texture, processing and organoleptic properties of chickpea-fortified spaghetti with insights to the underlying mechanisms of traditional durum pasta quality, *J Cereal Sci.* 49, 128-133. doi:10.1016/j.jcs.2008.07.016.

POSSIBILITIES OF APPLICATION OF EXTRUSION IN PRODUCTION OF NEW SNACK PRODUCTS

UDC 664.696.2 : 664.8.039.3

Gordan Avdić^{1}, Dijana Miličević¹, Nedreta Mujkić², Maida Selmić³, Azem Avdić¹*

¹University of Tuzla, Faculty of Technology, 75 000, Tuzla Bosnia and Herzegovina

*Corresponding author: gordan.avdic@untz.ba

²Factory "Corn flips" Food industry, Srebrenik, Bosnia and Herzegovina

³Factory "Pharmamed" d.o.o. Travnik, Dolac na Lašvi, Bosnia and Herzegovina

ABSTRACT

Extrusion is one of the most promising processes that are used in the food industry. The most important advantages of the extrusion which can be used as an unit operation in the process of food production, or may be the total process whereby food is produced. By changing the process parameters (temperature, pressure), by changing some parameters of the raw materials (moisture, other types of flour), or by combining with other procedures (drying, expanding, sugar coating) may be prepared by large number of different food products.

This paper examined the possibilities of application extruders last generation for the production of certain snack products (flips, bruschetti) with the addition of different flavours (chocolate, cocoa, smoked meat, etc.) and by-products of the food industry (apple pomace).

Keywords: extrusion, process parameters, apple trope, snack products

INTRODUCTION

Possibilities of application extruders last generation for the production of certain snack products with the addition of different flavors and by-products of the food industry are of particular importance for use in small and medium sized enterprises.

The new extruder has the ability to change the speed of the cochlea allowing great advantages of dosage for the desired quality of extrusion. Cooling the extruder head with water; it is possible is keep constant desired extruder head temperature.

At startup, it is not necessary to heat the head of extruder which results in savings in energy consumption and working hours.

The raw material to be extruded is retained very short in head extruder which allows insertion of additional components (cocoa powder, natural colors), and to remain in its original state.

Advantages of a new type related to the old type of extruder:

- the system of additional dosage which is used to start and stop of the extruder, can be used to insert additional components, if required by the product,
- system of additional dosing of water before entering into cochlea provides advantages of obtaining the desired texture of the product,
- the possibility of extrusion of different types of raw materials (corn meal, rice flour, starch flour, sugar, potato flour, as well as additives (colors, cocoa), allows a greater range of implementation of new products,
- scrap of product, which is created when moving and standing extruder is reduced to a minimum, which is a huge savings.

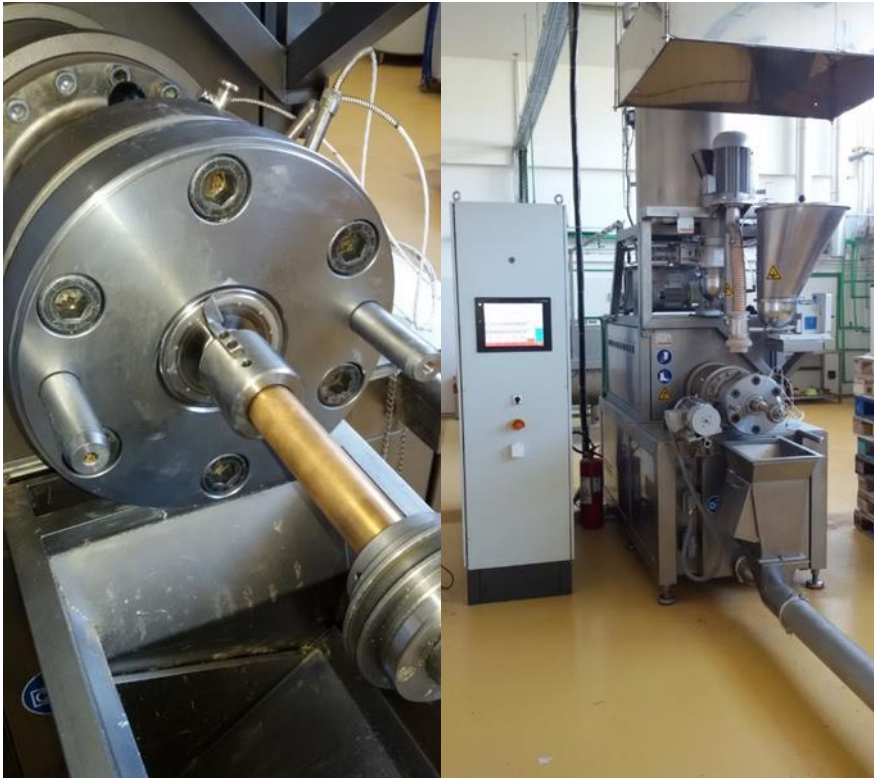

Figure 1. Extruder last generation

MATERIALS AND METHODS

The research was conducted on the industrial facility at extruder type Schaaf Technologie GmbH EKSTRUDER 60-C-925-DC, for the following products:

- Bread chips,
- Almond filled "Dark",
- Ball – Reference.

Production of bread chips

Table 1. Raw materials for production of bread chips

RAW EXTRUDATE	%
Wheat flour	87.8
Semolina (hard wheat grits)	5.0
Sugar	3.0
Gluten	3.0
Salt	1.0
Calcium carbonate	0.2
Sum	100.0
SLURRY	%
Plant fat	75.0
Spice mix	25.0
Sum	100.0
CRUST COLORING	%
Plant oil	97.0
Cocoa powder full fat	2.3
Annatto	0.5
Paprika extract	0.2
Sum	100.0

Production of Almond filled “Dark”

Table 2. Raw materials for production of Almond filled “Dark”

RAW EXTRUDATE	%
Rice flour	34.0
Sugar crystal	18.0
Wheat flour	31.0
Wheat bran fine handed	7.0
Cocoa powder full fat	4.5
Milk powder full fat	4.5
Salt	1.0
Sum	100.0
FILLING	%
Cocoa cream	100.0
Sum	100.0

Production of Ball – Reference

The recommended extrusion mode:

- cochlea configuration 4 : 1,
- nozzle diameter 4 mm,
- humidity mixing 15 %,
- temperature profile 135/170/170 °C.

Table 3. Raw materials for Production of Ball – Reference

RAW EXTRUDATE	%
Apple trop	20.0
Corn meal	80.0
Sum	100.0
FILLING	%
Plant oil	97.0
Cocoa powder full fat	2.3
Cinnamon	0.7
Sum	100.0

RESULTS AND DISCUSSION

Table 4. Product bread chips

FINAL PRODUCT	%
Wheat flour	62.34
Semolina (hard wheat grits)	3.55
Sugar	2.13
Gluten	2.13
Salt	0.71
Calcium carbonate	0.14
Plant oil	4.85
Cocoa powder full fat	0.12
Annatto	0.03
Paprika extract	0.01
Plant fat	18.0
Spice mix	6.00
Sum	100.0



Figure 2. Process parameters of production of bread chips (at the facility)



Figure 3. Temperature parameters of production of bread chips (at the facility)

Table 5. Product Almond filled “Dark”

FINAL PRODUCT	%
Rice flour	26.52
Sugar crystal	14.04
Wheat flour	24.18
Wheat bran fine grinded	5.46
Cocoa powder full fat	3.51
Milk powder full fat	3.51
Safe	0.78
Cocoa cream	22.00
Sum	100.00



Figure 4. Process parameters of production of Almond filled "Dark" (at the facility)

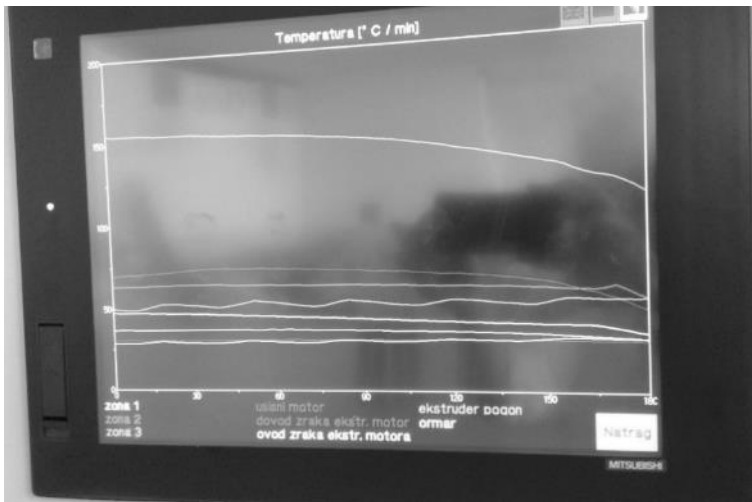

Figure 5. Temperature parameters of production of Almond filled "Dark" (at the facility)

Table 6. Product Ball – Reference

FINAL PRODUCT	%
Apple trop	18.69
Corn meal	74.77
Plant oil	6.34
Cocoa powder full fat	0.15
Cinnamon	0.05
Sum	100.0



Figure 6. Process parameters of production of Ball – Reference (at the facility)

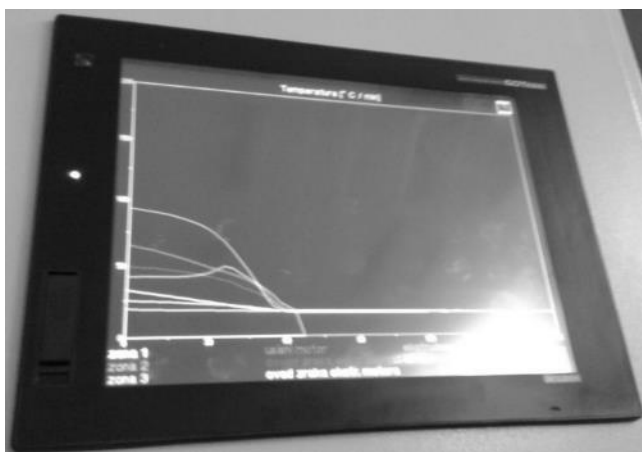

Figure 7. Temperature parameters of production of Ball – Reference (at the facility)

Process control at the facility

Energy input

Control of process parameters in an extrusion technique: SME (specific mechanical energy input).

The most important influencing factors: TURBO-configuration, the configuration of the nozzle, the viscosity of the dough and of course speed cochlea and the resulting torque (Figure 2, 4, 6).

Table 7. Controls at facility - Activity

HIGH	LOW
strong expansion	weak expansion
low density of extrudate	high density of extrudate
expansion with fine pores	texture with big bladders
low dough viscosity	high dough viscosity
low pressure of nozzles	high pressure of nozzles

Table 8. Controls at facility - Effect

INCREASE	DECREASE
decrease moisture of extrusion	increasing moisture of extrusion
increasing the speed of the cochlea	decrease the speed of the cochlea
increasing of energy input	decrease of energy input
TURBO-configuration change	TURBO-configuration change

Dough temperature

Considering that the raw material in the extruder is very strongly compressed, is generated from the friction, and therefore the heat, which causes comprehensive processes of change of components (sticking, etc. denaturation.). As a result of compression and of heat is obtained viscous, elastic dough. If the dough temperature substantially exceeds 100 °C, water evaporation at the nozzle aperture, which leads to expansion of the dough (Figure 3, 5, 7).

Viscosity of dough

Compression of raw materials obtained high viscosity dough. Its viscosity depends on the recipe, the water content and temperature increase, which is dependent of energy entering. Sugar, oil and water in the recipe reduces the viscosity of the dough, as well as energy input. As the dough is warmer, it is more rarely (Figure 2, 4, 6).

Nozzle pressure

Dough pressure reaches a maximum just before the nozzle and called nozzle pressure. Because the sensors for the direct measurement due to the complexity of handling and short exploitation life are not proved in practice, is abandoned the direct measurement on the display. But the value of pressure has still significant impact on energy input and type of expansion, which determines the structure of the final product.

CONCLUSIONS

Some of the snack products, with the addition of various flavoring and food industry by-products, can be produced with very simple quick change of head of extruder, and changing the process parameters, by changing some parameters of the raw materials, or by combining with other procedures. Regardless of the raw material composition, the regime of extruders operate have been observed significant deviations or breaks in production.

Process parameters of the extruder are stable in all the above products (except at the start and end of the process), mainly with temperature variations. This is important because of the addition of different flavors (chocolate, cocoa, smoked meat, etc.) and by-products of the food industry (apple pomace).

All this enables, in very short intervals, production of large number of different food products (spread chips, filled snack products, expanded products).

ACKNOWLEDGEMENTS

This work has been supported in part by Croatian Science Foundation under the project 1321.

REFERENCES

- Bogar, B., Szakacs, G., Tengerdy, R., Linden, J., Pandey, A. (2002): Production of α -amylase with *Aspergillus oryzae* on spent brewing grain by solid substrate fermentation, *Appl. Biochem. Biotechnol.* 102–103, 453–461.
- Dehnavi, G. (2009): Fractionation of the main components of barley spent grains from a microbrewery, Master thesis in Resource Recovery - Sustainable Technology, Department of Chemical Engineering, School of Engineering, University of Borås.
- Lovrić, T. (2003): "Procesi u prehrambenoj industriji s osnovama prehrambenog inženjerstva", HINUS Miramarska 13 b, Zagreb, 287-299.
- Mian N. Riaz, Ph.D. (2007): *Extruders and Expanders in Pet Food, Aquatic and Livestock Feeds*, Clenze, Germany.
- Mussatto, S., Dragone, G., Roberto, I. (2006): Brewer's spent grain: generation, characteristics and potential applications, *J. Cereal Sci.* 4, 1–14.
- Mussatto, S., Roberto, I. (2005): Acid hydrolysis and fermentation of brewer's spent grain to produce xylitol, *J. Sci. Food Agric.* 85, 2453–2460.
- Pejin, J. D., Radosavljević, M. S., Grujić, O. S., Mojović, Lj. V., Kocić-Tanackov, S.D., Nikolić, S.B., Djukić-Vuković, A. P.: Mogućnosti primene pivskog tropa u biotehnologiji, Univerzitet u Novom Sadu, Tehnološki fakultet, Novi Sad, Srbija, pregledni rad, 277-287.
- Pravilnik o proizvodima od žitarica ("Službeni glasnik BiH", broj 50/04), preuzeto sa www.uip-zzh.com/files/zakoni/19/76-10.pdf, Accessed 18.12.2014.
- Schaaf Technologie GmbH: *Basic Extrusion*, 1995.
- Tang, D., Yin, G., He, Y., Hu, S., Li, B., Li, L., Liang, H., Borthakur, D. (2009): Recovery of protein from brewer's spent grain by ultrafiltration, *Biochem. Eng. J.* 48, 1–5.
- Woodrooffe, J.M. (1993): *Dry Extrusion Applications in The Feed Industry*, Technical Bulletin, Vol 5, American Soybean Association.
- www.polj.savetodavstvo.vojvodina.gov.rs/node/4784, Accessed 21.12.2014.god.
- www.secerana.com/index.php?option=com, Accessed 21.12.2014.god.
- www.tehnologijahrane.com/enciklopedija/ekstrudiranje-u-prehrambenoj-industriji, Accessed 14. 12. 2014.

FORTIFICATION OF GLUTEN-FREE BISCUITS WITH BETAINE

UDC 664.681 : 543.92

Bojana Filipčev, Jelena Krulj, Jovana Brkljača, Olivera Šimurina, Dubravka Jambrec, Marija Bodroža-Solarov*

*University of Novi Sad, Institute of Food Technology,
Bul. cara Lazara 1, 21000 Novi Sad, Serbia*

**Corresponding author: bojana.filipcev@fins.uns.ac.rs*

ABSTRACT

Betaine is a non-essential nutrient whose principal physiologic function includes osmolyte action and methyl donation in transmethylation reactions. Increased blood concentrations i.e. dietary intake of betaine have been related to decreased risk of cardiovascular disease and metabolic syndrome. This paper investigated the effect of fortification of gluten-free biscuit formulation with varying levels of betaine (0.5, 1, 2, 3 % flour basis) on their quality.

Fortification increased the betaine content in the biscuits 4-21 times in comparison to the control. Betaine loss was estimated to be below 18%. High betaine fortification level (3 %) caused significantly higher biscuit spread and lower height gain. Textural properties did not significantly vary among the biscuit although 3 % betaine biscuit had somewhat lower strength. Fortification with betaine did not cause difference in the sensory properties except aftertaste. Weak aftertaste was perceived at the highest fortification level (3 %). The lightness and a^* values of biscuits were not different except for the biscuit fortified with 3 % betaine which were darker and higher in a^* values. Betaine addition contributed to the yellow tone and color vividness.

Keywords: betaine, biscuit, quality, texture, fortification

INTRODUCTION

Betaine (trimethylglycine) is a natural compound derived from sugar beet. Regarding chemical structure, it is a nitrogen compound and may be considered as an aminoacid or quaternary amine. Together with L-glutamine, betaine represents the major non-protein, water soluble, nitrogen component in sugar beets. Betaine performs critical functions in the human body; as an osmolyte, it increases the water retention of cells and protects them from osmotic stress while as a methyl donor, it is tied to choline and methionine metabolism by donating methyl groups in transmethylation reactions.

Nutritionists commonly list betaine in the group of B vitamins but it is often referred to as a quasi-vitamin. It is not an essential nutrient because it can be formed endogenously but, according to some opinions, it cannot be synthesized in adequate quantities and generally needs to be included in the diet. Humans obtain betaine from foods that contain either betaine or choline. Food rich in betaine content includes wheat bran, wheat germ, chinoa,

spinach, beets and shellfish (Ross, *et al.*, 2014; Craig, 2004; Zwart de, *et al.*, 2003). Sugar beet molasses is an abundant source of betaine. Literature data report that beet molasses contains around 5-6 % betaine, which is sufficiently high concentration for practical extraction. Betaine increased in popularity when it was revealed that it is effective in lowering elevated total plasma homocysteine. Even mild or moderate elevation of homocysteine is a risk factor for many cardiovascular diseases (high cholesterol, heart attack, stroke). It is also claimed that betaine may reduce the risk from development of neural tube defects, cancer incidence, liver disease, depression and peripheral neuropathy. Several studies inferred that dietary intake of betaine might be effective in lowering the cardiovascular risk (Craig, 2004; Olthof, *et al.*, 2003; Zwart de, *et al.*, 2003). Commission regulation (EU) No 432/2012 allows a health claim to be made on food which contains at least 500 mg betaine per quantified portion. The health claim implies that betaine contained in the product contributes to normal homocysteine metabolism under condition that a total daily betaine intake reaches 1.5 mg. Ross *et al.* (2014) identified cereal foods to be the major source of betaine in the Western diet and outlined the importance of wheat, especially wholegrain wheat as a source of betaine in the diet. They also emphasized that people avoiding gluten are likely to have low betaine intake. Therefore, the present research was designed to study the possibility of fortifying a gluten-free biscuit formulation with various doses of betaine (0.5, 1.0, 2.0, 3.0 % non-glutenous flour basis). The main objective was to evaluate the quality characteristics of fortified biscuits and the effect of baking on betaine content in the biscuits.

MATERIALS AND METHODS

Biscuit preparation

Gluten-free biscuits were prepared from corn starch (70 g), rice flour (30 g), vegetable fat (30 g), powdered sugar (30 g), salt (1 g), sodium bicarbonate (1 g), ammonium bicarbonate (0.75 g) and water (20 g). Starch, rice, sugar, salt and the rising agents were obtained from local food stores and supermarkets in Novi Sad, Serbia. Trans fat-free vegetable fat was procured from Puratos d.o.o., Kragujevac, Serbia. Anhydrous betaine of 98 % purity (Alfa Aesar GmbH&Co KG, Germany) was used to fortify the biscuits. Betaine was dosed at 0.5, 1.0, 2.0 and 3.0 % calculated on non-glutenous flour weight (corn starch+rice flour). The ingredients were mixed using the „all-in“ procedure for 7 min. Dough was left to rest for 30 min. Then it was laminated, manually cut and baked in a deck oven MIWE (Michael Wenz, GmbH, Germany) at 170 °C for 12 min.

Betaine determination

Betaine analysis was performed by HPLC system Agilent (Agilent Technologies Inc., USA) coupled with a Kinetex (Phenomenex, Germany) column and ELSD detector. The food samples were extracted in methanol.

Biscuit properties

Biscuit geometry was measured using a digital calliper. Breaking strength and distance of biscuits was measured by applying the three-point break technique using a texture analyzer TA-Xtplus (Stable Micro Systems, Godalming, England). The texture parameters were determined 24 h after baking.

Colour properties

The colour of gluten-free biscuit samples was measured using a Minolta Chromameter (Model CR-400, Minolta Co., Osaka, Japan), with attachment CR-A33b. All the samples were illuminated with D65-artificial daylight (10° standard angle). Prior measurements, the colorimeter was calibrated against a standard white plate ($Y=84.8$, $x=0.3199$, $y=0.3377$). The colour values were expressed as L^* (whiteness/darkness), a^* (redness/greenness) and b^* (yellowness/blueness).

Sensory analysis

Sensory analysis was carried out on day 1 after biscuit manufacturing by a 6-member trained panel recruited from the researcher staff of the institute. The panel was experienced and underwent an orientation session. The panellists rated each product, flavor, aftertaste and texture using a 1-9 scale for overall acceptability and overall quality (1 extremely dislike or low; 9 extremely like or high), taste and aftertaste (1 too low intensity; 9 too strong intensity); texture (1 too soft; 9 too hard).

Statistical analyses

One-way ANOVA procedure was used to analyze data. Tukey's test was used to determine statistically significant differences among means. A 95 % significance level was considered in all comparisons. Statistical software Statistica 12 from StatSoft, Tulsa, Oklahoma was used.

RESULTS AND DISCUSSION

Table 1 presents the betaine content in the manufactured biscuits. The betaine contents of fortified biscuits was significantly higher than that of the control biscuit ($p<0.05$) and increased as the level of fortificant increased. In comparison to the control, betaine content was 4-21 times higher in the fortified biscuits. The betaine loss of the fortified formulations was derived by calculation comparing the actual betaine contents in the fortified biscuits and the expected contents. The betaine loss ranged from 10.8 % to 17.9 %. This coincides with the findings of de Zwart *et al.* (2003) who reported 17 % betaine loss in baked scones.

Unlike cane molasses, sugar beet molasses is a natural source of betaine. In earlier studies, it was shown that beet molasses can be used to fortify gluten-free biscuits. For comparison, betaine content of such biscuit is given in Table 1. The biscuits prepared with 20 % beet molasses (flour basis) contained appreciable amounts of betaine which corresponded to

betaine fortification levels between 0.5 and 1 % (flour basis). By consuming 100 g of betaine-fortified biscuit, an intake of 280, 540, 960 and 1370 mg betaine can be expected, depending on the level of fortification. Reported daily betaine intakes are <150 mg/d (Slow, *et al.*, 2005) whereas health effects may be expected at doses equal or higher than 1.0-1.5 g/d. Some authors implied that the design of a palatable diet providing >800 mg/d betaine is difficult to achieve (Lever & Slow, 2010).

Table 1. Betaine content in the fortified gluten-free biscuits

Betaine fortification level	Moisture content (g/100 g)	Betaine (mg/100 g d.m.)	Betaine loss (%)
Control	4.18	68.37	-
0.5 %*	4.45	293.83	16.7
1.0 %	4.35	570.66	10.8
2.0 %	4.36	1004.22	16.7
3.0 %	4.18	1430.05	17.9
Molasses enrichment level			
Control	6.61	11.05	-
20 %	6.47	442.09	-

*g per 100 g non-glutenous flour basis.

Table 2. Physical and textural properties of the fortified gluten-free biscuits

Betaine fortification level	Mean diameter (mm)	Height gain (%)	Spread	Strength (kg/mm)	Distance at break (mm)
Control	42.60±0.56 ^b	146.19±4.75 ^{b,c}	3.81±0.26 ^b	0.126±0.029 ^{a,b}	1.01±0.38 ^a
0.5%*	40.41±0.30 ^a	180.87±12.69 ^c	3.26±0.19 ^{a,b}	0.186±0.021 ^b	0.97±0.10 ^a
1.0%	42.04±0.25 ^b	147.80±21.13 ^{b,c}	3.56±0.23 ^{a,b}	0.142±0.027 ^{a,b}	0.95±0.19 ^a
2.0%	42.46±0.53 ^b	119.35±10.39 ^{a,b}	4.20±0.29 ^b	0.120±0.029 ^a	0.95±0.35 ^a
3.0%	45.57±0.54 ^c	91.4±16.95 ^a	5.37±0.53 ^c	0.106±0.012 ^a	0.96±0.29 ^a

The baking performance of betaine-fortified biscuits is presented in Table 2. All biscuits were crispy due to rather high sugar content in the basic formulation. The upper surface was bumpy and blister like due to formation of large wholes in the biscuit crumb. The samples fortified with up to 2 % betaine had very similar characteristics and did not differ much from the control in most of the cases. Higher fortification level (3 %) caused higher biscuit spread and lower height gain. According to Finney *et al.* (1950) sufficient spread

and well broken top is desirable in GF biscuits. Regarding textural properties, the biscuits did not significantly differ from the control, although 3 % betaine slightly decreased the biscuit strength. The samples did not significantly differ in fracturability though the betaine fortified samples tended to be somewhat more fracturable. Kilibwa (2001) claimed that betaine in wheat-based cookies (rich cookie formulation with fat and milk products) increased their softness.

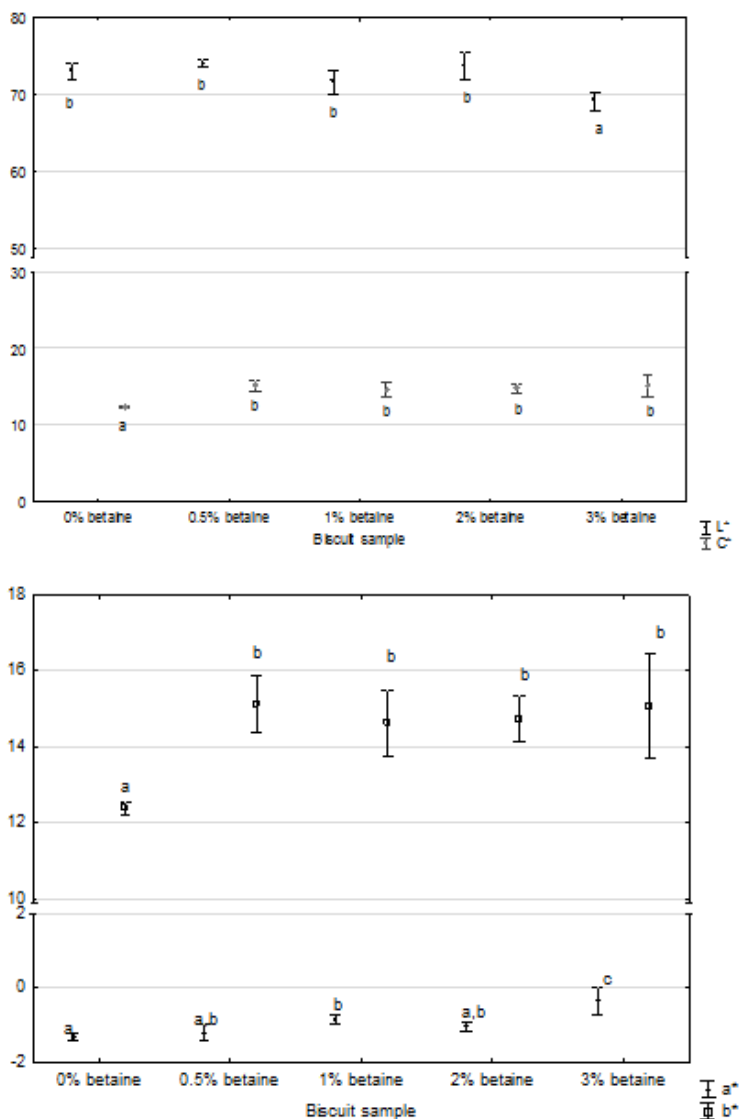

Figure 1. Color properties of gluten-free biscuits

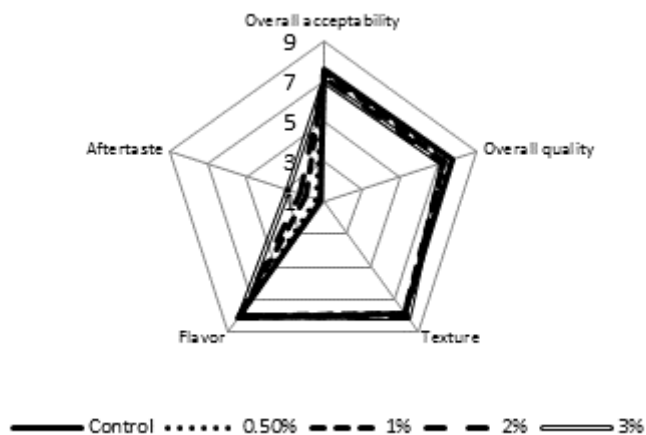

Figure 2. Sensory properties of fortified gluten-free biscuits

Color properties are displayed in Fig. 1. Betain fortification caused changes in the color properties of gluten-free biscuits. Significant differences between the control and the betaine-fortified samples were observed in chroma and yellowness ($p < 0.05$). The fortified biscuits were more yellow with a more vivid and intense color. Increased betaine level contributed to elevated a^* values, shifting the values closer to zero position. The lightness of biscuits was less affected by betaine; only the sample fortified with 3 % betaine was significantly darker than the others. This might be due to possible reaction of higher doses of betaine (aminoacid) with sugar in Maillard reactions that contributed to the formation of colored products that decreased biscuit brightness.

Overall acceptability and sensory rankings are shown in Fig. 2. There was no significant difference in the overall acceptability among the presented fortified and the control biscuits. Other sensory attributes, such as overall quality, texture and taste also did not significantly differ among the formulae. Weak aftertaste resembling metallic was perceived at 3 % fortification level but not by all trained assessors. The aftertaste maybe due to weak acid reaction of betaine which may contribute to sensations of tongue and palate in sensitive persons. It has been reported that

betaine has a mildly sweet taste and may have a slightly bitter aftertaste (Arrowhead Health Works, 2015). Sweetness of the fortified gluten-free biscuits was not affected by the rising doses

of betaine because the used formula was based on appreciable amount of sugar which contributed to initial strong sweet taste. Kilibwa (2001) stated that betaine added to various baked goods (all wheat based) exhibited flavor enhancing properties but it should noted that this was observed in complete, rich, food formulations containing various flavors or their combinations whereas in our case, a simplified formulation including only basic ingredients was used.

CONCLUSIONS

Inclusion of betaine to the recipe formulation of gluten-free biscuit can affect the spread and aftertaste at 3 % fortification level. Strength and fracturability of the biscuits, as well as the other sensory attributes were not significantly affected. Betaine addition contributed to increased yellowness and more vivid color in comparison to the control. The highest level of fortification (3%) increased the red tone and darkness in comparison to all other samples. Fortification increased the betaine content in the biscuits 4-21 times in comparison to the control. Betaine loss was estimated to be below 18 %. It can be suggested that these fortified biscuits seem suitable as an alternative to plain gluten-free biscuits, thus their consumption may be a convenient approach to increase dietary betaine intake.

ACKNOWLEDGEMENTS

The authors are grateful to announce the support from the Provincial Secretariat of Science and Technological Development (the Province of Vojvodina, grant 114-451-1439/2014) and the Ministry of Education, Science and Technological Development of the Republic of Serbia (TR 31055).

REFERENCES

- Arrowhead Health Works. 2015. Trimethylglycine (TMG) anhydrous betaine, bulk, ultrafine granulated. <http://www.arrowheadhealthworks.com/TMG.htm>. Accessed May 26, 2015.
- Commission Regulation (EU) No 432/2012 (2012): Establishing a list of permitted health claims made on foods, other than those referring to the reduction of disease risk and to children's development and health. O. J. L. 136, 25.05.2012, p. 5.
- Craig, S. A. S. (2004): Betaine in human nutrition. *Am. J. Clinical Nutr.* 80, 539-548.
- Finney, K., Morris, V., Yamazaki, W. (1950): Micro versus macro cookie baking procedures for evaluating the cookie quality of wheat varieties. *Cereal Chem.* 27(1), 42-49.
- Kilibwa, M. (2001): Betaine and bakery products. USA, Patent No. US 6,217,930 B1.
- Lever, M., Slow, S. (2010): The clinical significance of betaine, an osmolyte with a key role in methyl group metabolism. *Clinical Biochem.* 43(9), 732-744.
- Olthof, M., Vliet van, T., Boelsma, E., Verhoef, P. (2003): Low dose betaine supplementation leads to immediate and long term lowering of plasma homocysteine in healthy men and women. *J. Nutr.* 133, 4135-4138.
- Ross, A., Zangger, A., Guiraud, S. (2014): Cereal foods are the major source of betaine in the Western diet - Analysis of betaine and free choline in cereal foods and updated assessments of betaine intake. *Food Chem.* 145, 859-865. <http://dx.doi.org/10.1016/j.foodchem.2013.08.122>
- Slow, S., Donaggio, M., Cressey, P.J., Lever, M., George, P.M., Chambers, S.T. (2005): The betaine content of New Zealand foods and estimated intake in the New Zealand diet. *J. Food Comp. Anal.* 18, 473-485. <http://10.1016/j.jfca.2004.05.004>
- Zwart de, F. *et al.* (2003): Glycine betaine and glycine betaine analogues in common foods. *Food Chem.* 83, 197-204. [http://10.1016/S0308-8146\(03\)00063-3](http://10.1016/S0308-8146(03)00063-3)

INTAKE OF GRAINS AND GRAIN BASED PRODUCT AND DIET QUALITY IN TODDLERS

UDC 664.696 : 613.22

*Ivana Rumbak**, *Kristina Petrčić***, *Tihana Kunić***, *Tea Ištvančić***, *Irena Colić Barić*

*Department of Food Quality Control, Faculty of Food Technology and Biotechnology, University of Zagreb, Pierottijeva 6, HR-10000 Zagreb, Croatia (**Student of Faculty of Food Technology and Biotechnology, Zagreb)*

**Corresponding author: icecic@pbf.hr*

ABSTRACT

Appropriate feeding of complementary and table foods to young children may ensure normal growth, promote healthy eating habits, and help prevent obesity and other health problems during and after childhood. The aim of this study was to estimate the intake of grains and grain based products in toddlers. Our research was based on a sample size of 102 participants (43 girls and 59 boys) who kept a three day food diary. Grains and grain based products contributed with 25.61 % to their total daily energy intake. On average, participants consumed 105.46 g of grains daily, and only 63.73 % of participants have met the recommended values for grain intake (United States Department of Agriculture, 2011). Refined grains contributed the most in grains intake, with 59.56 g, with the average consumption of whole grains being 12.76 g. Bread and cereals were most commonly consumed products. This study has provided results that had been missing for the toddler population in Croatia. However, it is necessary to include more participants from different parts of Croatia to provide representative results.

Keywords: toddlers, energy intake, grains

INTRODUCTION

Proper nutrition is nutrition that provides optimal intake of energy, vitamins, minerals and fluids to the body. It is important at any age, but its significance is most prominent during periods of greatest growth and development such as early childhood and adolescence. After a one year period an infant becomes a toddler and his diet changes so that it includes more food variety from multiple different food groups and therefore it is important to know what, when, how much and how to offer food to a child as part of a regular diet.

It is important to harmonize toddler nutrition with dietary recommendations and to provide the recommended intake of energy and nutrients, to develop desirable eating habits and to adopt healthy lifestyles which, together with proper nutrition, encourage regular physical activity. Individual energy requirements for toddlers vary depending on growth and physical activity (Whitney and Rolfes, 2012). Inadequate energy intake can result on one hand with malnutrition and increased predisposition to infections, and on

the other with excess fat and metabolic disorders (Vučemilović i Šisler, 2007). Positive or negative support of environmental factors with social component determines a person's health in adulthood. High quality food and good health are closely connected throughout life, but this connection is most obvious during early childhood.

The aim of this study was to estimate the intake of grains and grains products and diet quality in toddlers (1-3 years old) using dietary records for 3 non-consecutive days.

MATERIALS AND METHODS

The study included 102 children, of whom 43 were girls and 59 were boys, aged 1-3 years from the City of Zagreb and Zagreb County. All parents agreed voluntarily to participate in the study and they gave their written consent for participation. Participants were recruited through friends and acquaintances and via social media. For the purposes of recruiting online participants we made the toddler nutrition questionnaire Google application form. A dietetic method used was food record for three non-consecutive days. Subjects were instructed how to fill out general questionnaire and how to conduct food record for the period of three days. It was important to monitor nutrition on either Saturday or Sunday and on two working days. Moreover, the participants were instructed to avoid days when the child have been ill because such circumstances can change normal food intake. The guidelines included detailed instruction about how to measure different foods, how to write recipe for complex dishes, example of filled one-day food diary, templates for measuring the food dimensions and picture with size of food utensils. Data collection was followed by the entry of food records in a Microsoft Excel document. Food composition tables and food labels data for certain food items that were missing were used for conversion of food intake data into energy and nutrient intake (Kaić-Rak and Antonić, 1990; Møller *et al.*, 2005; USDA, 2014). Because of the difficulty of determining the approximate consumed volume of breast milk, breast milk wasn't added to the total energy and nutrient intake of participants. For an estimation of intake of grains and grain based products, foods that contribute to the intake of grains and grain based products were divided into 6 groups: refined grains, quick breads, pasta, whole-grains bread (bread, crackers, bagels), grains for breakfast and rice. Estimated Average Requirements (EAR) were used to estimate inadequate intake of nutrients, and if EAR weren't available, then Adequate Intake (AI) was used. Acceptable Macronutrient Distribution Range (AMDR) was used to estimate the intake of macronutrients.

RESULTS AND DISCUSSION

Table 1 shows the total dietary intake of toddlers relative to the recommendations. The average energy intake is similar to the recommendations for energy intake and amounts to 1232.01 ± 350.75 kcal and 28.43 % of children had an intake in accordance with recommended values. Intake under recommendations had 20.59 % of respondents, while 50.98 % of participants had intake over recommended values. This is in accordance with other surveys conducted in the United States (Sharma *et al.*, 2013) and in the Netherlands (Gubbels *et al.*, 2014).

Table 1. Total daily intake of toddler in comparison with the recommendation (IOM, 2002)

Parameter	Daily intake	Recommendation	Proportion of toddlers whose intake is in accordance with recommendations
Energy intake (kcal)	1232.01 ± 350.75	1076.73 ^a	28.43 %
Macronutrients (% energy intake)			
Proteins	15.72 ± 2.77	5-20 ^b	94.12 %
Carbohydrates			
Total carbohydrates	57.05 ± 8.23	45-65 ^b	80.39 %
Fat			
Total fat	31.72 ± 5.74	30-40 ^b	51.96 %
Saturated fat	12.83 ± 2.98	Low intake ^b	-
Omega-3 fatty acids	0.18 ± 0.09	0.60-1.20 ^b	0 %
Omega-6 fatty acids	0.90 ± 0.64	5-10 ^b	0.01 %
Dietary fiber (g)	16.53 ± 6.54	19 ^c	12.75 %

^aDietary Reference Intake, DRI

^bAcceptable macronutrient distribution range, AMDR

^cAdequate intake, AI

Average daily protein intake as a percentage of daily energy intake was 15.72 ± 2.77 % where 94.12 % of the participants met the recommendations for protein intake. Similar results were obtained in studies in the UK (Gibson and Sidnell, 2014) and in the Netherlands (Gubbels *et al.*, 2014). The average carbohydrate intake was 57.05 ± 8.23 % of daily energy intake. Recommendations for carbohydrate intake were met by 80.39 % of participants, while 15.69 % of participants had an intake greater than the recommended values, which is in accordance with other surveys conducted in the United States (Sharma *et al.*, 2013) and in the Netherlands (Gubbels *et al.*, 2014). Average fat intake was 31.72 ± 5.74 % of daily energy intake. The recommended values for fat intake were met by 51.96 % of participants, while 42.16 % of participants had an intake less than recommended for fat intake. The average intake of omega-3 fatty acids was 0.18 ± 0.09 % of daily energy intake, which is three times less than the recommended intake. None of the subjects had recommended intake of omega-3 fatty acids. The average intake of omega-6 fatty acids was 0.90 ± 0.64 % of daily energy intake, and only 1 participant had the recommended intake. A similar entry, lower than recommended, was reported in the study in the United States (Sharma *et al.*, 2013). The average intake of saturated fatty acids is 12.83 ± 2.98 % of daily energy intake, which is very similar to the study in the United States (Sharma *et al.*, 2013) and to the Dutch study (Gubbels *et al.*, 2014).

The average intake of dietary fiber was 16.53 ± 6.54 g, which is less than the recommended intake that was met by only 12.75 % of participants. This is in accordance to the research conducted in the Netherlands (Gubbels *et al.*, 2014). Given the results of the 2002 Feeding Infants and Toddlers Study from the United States where the average intake of dietary fiber was 8 g daily (Devaney *et al.*, 2004) results of this study were satisfactory, but it is still necessary to improve the intake of dietary fiber in toddlers whose intake was lower than recommended.

Table 2. The proportion of toddlers who met micronutrients recommendations and contribution of micronutrients from grains and grain based products in average daily intake

Nutrient	Proportion of toddlers whose intake is in accordance with recommendations	Percentage of grains and grain based products in intake of micronutrients
Vitamin A (µg)	29.41 %	6.84 %
Thiamine (mg)	99.02 %	2.04 %
Riboflavine (mg)	98.04 %	0.46 %
Niacin (mg)	95.10 %	1.39 %
Vitamin B ₆ (mg)	99.02 %	1.81 %
Folate (µg)	99.02 %	17.14 %
Vitamin B ₁₂ (µg)	96.08 %	0.78 %
Vitamin C (mg)	100 %	0.00 %
Vitamin D (µg)	0 %	2.73 %
Vitamin E (mg)	70.52 %	8.48 %
Copper (µg)	99.02 %	0.00 %
Zinc (mg)	99.02 %	23.11 %
Phosphorus (mg)	98.04 %	22.90 %
Iodine (µg)	66.67 %	10.00 %
Calcium (mg)	61.76 %	5.91 %
Potassium (g)	3.92 %	12.31 %
Magnesium (mg)	99.02 %	33.87 %
Natrium (g)	89.22 %	16.88 %
Selenium (µg)	59.80 %	16.50 %
Iron (mg)	99.02 %	35.59 %

Table 2 shows the proportion of grains and grain based products in total intake of micronutrients. Grains and grain based products contribute to the intake of folate, iron, zinc, phosphorus, magnesium, sodium and selenium. The contribution of grains and grain

based products to total micronutrient intake of these nutrients was expected (United States of Agriculture, 2015).

Satisfactory vitamin A intake had 29.41 % of participants, which is in line with research in the United States where 35 % of participants also had satisfactory vitamin A intake. Only 2/3 of participants had satisfactory iodine, selenium and calcium intake. In the United Kingdom research a small percentage of children were at risk of iodine deficiency and selenium, which is similar to the results of this study (Gibson and Sidnell, 2014.). Satisfactory potassium intake had 3.92 % of participants which is a very small percentage, making it necessary to include potassium rich foods, such as fruit and vegetables, in toddler's diets and reduce the intake of processed food (NIH, 2014).

Most participants had an adequate intake of micronutrients, with the exception of vitamin D, vitamin A, iodine, potassium, selenium and calcium. More than 90 % of children met the dietary recommendation for B vitamins, vitamin C, copper, zinc, phosphorus and iron.

None of the participants met the recommendation for vitamin D. Vitamin D supplementation was not included, but only 16.67% of participants used vitamin D as dietary supplement, which is a very small percentage, considering that vitamin D is a particularly important nutrient because it is essential for the absorption of calcium and therefore bone mineralization. Similar findings in vitamin intake were obtained in a research from the United Kingdom where 91 % of participants didn't meet the recommended vitamin D intake. Similarly, only a very small percentage of children used vitamin D supplements, only 11 % (Gibson and Sidnell, 2014). On the other hand, the findings of the 2002 Feeding Infants and Toddlers Study from the United States point to a sufficient vitamin D intake (Devaney *et al.*, 2004).

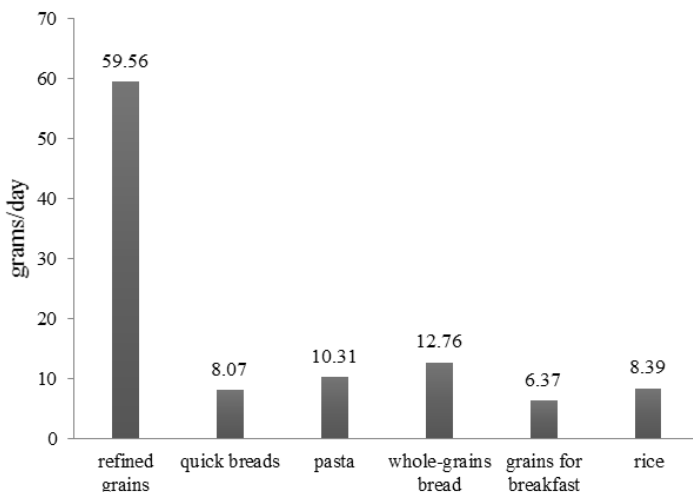

Figure 1. The average daily intake of cereals and cereal products (grams / day)

Grains and grain based products make up to 25.61% of total daily energy intake. Average daily intake of grains and grain based products is 105.46 g, and 63.73 % of participants meet the recommendations for grain intake (United States Department of Agriculture, 2011). Refined grains contributed the most to total grains intake with average daily intake of 59.56 g, and average consumption of whole grains was 12.76 g.

Whole grains contributed only 12 % energy intake to total daily energy intake of grains which is less than the recommended intake of whole grains, that should amount to 50 % of the recommended daily intake of whole grains (Figure 2) (United States Department of Agriculture, 2011). Low intake of whole grains is consistent with low percentage of participants who consume whole grains.

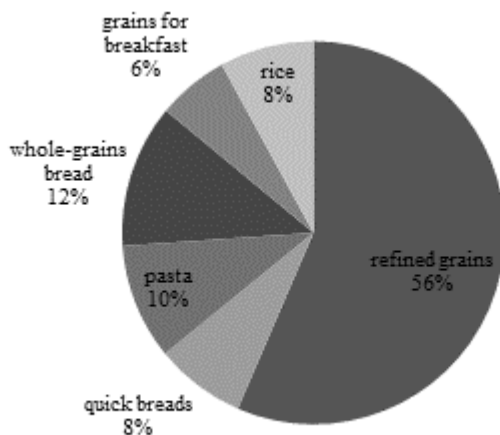

Figure 2. Distribution of 6 groups of grain products to total daily intake of grains and grain based products

CONCLUSIONS

It can be concluded that grains and grain based products contributed mostly to the intake of folate, iron, zinc, phosphorus, magnesium, sodium and selenium. Total average daily intake of omega-3 and omega-6 fatty acids was identified as inadequate in almost all participants in the study. It is necessary to increase intake of dietary fiber in toddlers, whose intake was lower than recommended. Low intake of whole grains highlighted the need for future research on larger representative sample of participants and for interventions about proper nutrition targeting parents of young children

REFERENCES

- Devaney, B., Ziegler, P., Pac, S., Karwe, V., Barr, S. I. (2004) Nutrient Intakes of Infants and Toddlers, *J. Am. Diet. Assoc.* 104, S14-S21.
- Gibson, S., Sidnell, A. (2014) Nutrient adequacy and imbalance among young children aged 1–3 years in the UK, *Nutr. Bull.* 39, 172-180.
- Gubbels, J., Raaijmakers, L. G. M., Gerards, S. M. P. L., Kremers, S. P. J. (2014) Dietary Intake by Dutch 1- to 3-Year-Old Children at Childcare and at Home, *Nutrients* 6, 304-318.
- IOM (2002) Dietary Reference Intakes for Energy, Carbohydrate, Fiber, Fat, Fatty Acids, Cholesterol, Protein, and Amino Acids, IOM – Institute of medicine of the national academics, Washington, D.C., <<http://www.iom.edu/?id=12702>>. Accessed June 10, 2014.
- Kaić-Rak, A., Antičić, K. (1990) Tables of food and drink contents, Croatian National Institute of Public Health, Zagreb, Croatia.
- Møller, A., Saxholt, E., Christensen, A. T., Hartkopp, H. B., Hess Ygil, K. (2005) Danish Food Composition Databank, revision 6.0. Food informatics, Department of Nutrition, Danish Institute for Food and Veterinary Research. <<http://www.foodcomp.dk/>>. Accessed April 25, 2014.
- Sharma, S., Kolahdooz, F., Butler, L., Budd, N., Rushovich, B., Muklina, G. L., Gittelsohn, J., Caballero, B. (2013) Assessing dietary intake among infants and toddlers 0–24 months of age in Baltimore, Maryland, USA, *Nutr. J.* 12, 52.
- United States Department of Agriculture - USDA (2011) ChooseMyPlate – Printable Materials&Ordering, <<http://www.choosemyplate.gov/print-materials-ordering/mypyramid-archive.html>>. Accessed June 22, 2014.
- United States Department of Agriculture - USDA (2011) ChooseMyPlate – All About the Grains Group, <<http://www.choosemyplate.gov/grains>>. Accessed June 25, 2015.
- United States Department of Agriculture - USDA (2014) United States Department of Agriculture – National Nutrient Database for Standard Reference, Release 26, <<http://ndb.nal.usda.gov/ndb/search/list>>. Accessed June 10, 2014.
- Vučemilović, Lj, Vujić Šisler, Lj. (2007) Food standard for planning nutrition of children in kindergarten – menus and norms, Croatian Nurses Association, Office for Education, Culture Sports, Sector preschool department, Zagreb.
- Whitney, E. N., Rolfes, S. R. (2012) Life Cycle Nutrition: Infancy, Childhood, and Adolescence. In: *Understanding Nutrition*, 13. ed., Wadsworth/Thomson Learning, Belmont, pp. 547-573.

HEMP PRODUCTS FOR FOOD AND MEDICINE USING

UDC 664.64.016.7

Marie Hrušková*, Ivan Švec

University of Chemistry and Technology Prague, department of Carbohydrates and Cereals,
Technická 5, 166 28 Prague 6, Czech Republic

*Corresponding author: Marie.Hruskova@vscht.cz

ABSTRACT

Hemp (*Cannabis sativa*) is an annual plant that is native to China and remained for centuries as an important material for food, industrial and medical purposes. As a source of cannabinoids belongs to controversial, but due to its excellent nutritional profile, non-gluten protein, fat and fibre it has a potential in bakery products. Protein, fat and starch rates are known to be 30-33 %, 7-13 %, approx. 40 %, respectively. Cannabis increases the "gastric fire" (i.e., digestion and, therefore, appetite). The prime medicinal uses are for nervous system, gastrointestinal tract and as an aphrodisiac. Whole seeds can be used as component of cereal sticks, biscuits and bread. For bakery products, 10 % and 15 % was recommended as acceptable. Wheat-hemp cut off cookies had pleasant coffee brown colour and specific by-taste. Pasta containing hemp products from hulled and dehulled seeds were characterised by up to four times higher fibre content compared to wheat ones. Flower parts of hemp plant are known by the important content of cannabitol (CBN).

Keywords: hemp products, cannabinoids, bread, cookies

INTRODUCTION

Hemp (*Cannabis sativa*) is an annual plant that is native to China and remained for centuries as an important material for food, industrial and medical purposes. As a source of cannabinoids belongs to controversial, but due to its excellent nutritional profile, non-gluten protein, fat and fibre it has a potential in food products. Hemp seeds, which contain a low level (0.3 %) of tetrahydrocannabinol (THC), are legally grown in Czech republic. Press-cake, as a by-product of the cold-pressing hemp oil process, is rich in proteins, fibers, phytochemicals, minerals, linoleic (omega-6), and alpha-linolenic (omega-3) essential fatty acids, as well as gamma-tocopherols (Callaway 2004).

Hemp (*Cannabis sativa*) is planted as two subspecies, namely *ssp. culta* and *ssp. indica*. The latter is called hash hemp and belongs to forbidden raw material with respect to intoxicating substances production. Hemp flour composition depends on variety and planting locality, also differs according to level of dehulling or defatting. Protein, fat and starch rates are known to be 30-33 %, 7-13 %, approx. 40 %, respectively. Seed contains a significant level of beta-carotene and vitamins B₁ and E. Considering mineral component

aspect a benefit could be found in higher portion of iron and zinc. Approx. two-thirds of hemp proteins is composed by edestin, belonging to low molecular weight globulins. Content of 10 – 15 % insoluble fibre (Heroudková, 2013) may be also reason for wheat flour fortification.

Usage of hemp seed in food industry

Hemp flour is suitable for celiatics, because here's a lack of gliadin fractions of protein. Whole seeds can be used as component of cereal sticks, biscuits and bread, or they could be consumed after roasting treatment. Seed skin softens after heating, thus hulled seeds may season cooked dishes as pasta, rice or sausages. Dehulled seeds could also be included into non-cooked dishes. Mixed with water, 'hemp milk' is prepared suitable for taste emphasizing of chips, pasta and tortillas (Heroudková, 2013). In amount between 10 % and 15 %, hemp flour could be added into bakery products (Ruman, 2014). Incorporated into cut off cookies, pleasant coffee brown colour and specific by-taste could be reached (Hrušková *et al.*, 2011). Pasta containing hemp products from both form of seeds were characterised by up to four times higher fibre content compared to wheat ones (Hrušková and Švec, 2012).

For bakery usage, different commercial hemp products could be applied. Fine or wholemeal flour gained by disintegration of hulled or dehulled seeds could be counted, or protein concentrates of domestic or foreign origin. From technological point of view, chemical composition limits their potential usage as their presence in recipe affects bread dough machinability in terms of gluten protein dilution.

Usage of hemp seed in medicine

The female flowers before pollination are a major source of resin, the leaves the secondary source. This fact is reflected in the common modes of preparing cannabis for medical use. *Bhang*, the weakest type, consists simply of the dried leaves, with the flowering tops removed when it is carefully prepared. The leaves are exposed to sun and dew alternately. *Ganja* is made of the female flowering tops alone to which the resin adheres. The tops are put in heaps and trodden or manually rolled. *Western hashish* differs in being composed of flowers and leaves, which are boiled with butter. The most potent product, *charas*, is almost entirely pure resin from top of female plants.

Cannabis increases the "gastric fire" (indigestion and, therefore, appetite) and the "generative fire," as it is mentioned in one of the earliest medical works by the Sushruta Samhita (of uncertain date with estimates ranging from 400 B.C.-600 A.D.). Cannabis can be used medicinally for almost all the illnesses flesh. The prime use are for the nervous system, the gastrointestinal tract and as an aphrodisiac. It was commonly employed for many other functional or organic troubles. Cannabis serves as much a panacea for respiratory disturbances, especially those involving oversecretion of mucus, pain or frequent coughing, as for gastric malfunction. Further, it is used for a wide variety of infectious diseases, so much so that it has been referred to as the "penicillin of Ayurvedic

medicine". It may have been only the analgesic properties that was active or it may have had some effect on the rheumatism itself. Now is widely accepted as being one of the autoimmune classes of diseases. Some cannabis constituents have been shown to be antihistaminic, like the corticosteroids used to palliate autoimmune diseases. The analgesic properties of cannabis ensured its application against a wide variety of painful conditions. Cannabis was applied to every conceivable sort of spasm or convulsion, from simple stomach cramps, to tetanus or epilepsy (Hurt *et al.*, 2014).

Presented work was aimed at hemp flour type and addition level effects on composite mixture and comparison in terms of analytical and nutritional aspect, so from viewpoint of bread quality characteristics. Cannabinoids of leaf and flower parts of varieties of *Cannabis sativa* were evaluated.

MATERIALS AND METHODS

Cereal mixtures were based on commercial wheat flour M, and it was blended with three samples of commercial fine hemp flour (K1, K2, K3), and with two samples of hemp wholemeal (dehulled K4 and hulled K5). Model samples were blended in ratios 95:5, 90:10, 85:15 and 80:20 (w/w), and were named by hemp flour type and substitution level, e.g. K1.10 or K5.20. In terms of basic analytical composition of wheat flour and tested composites, protein content (PRO) and quality (Zeleny's sedimentation value, ZET) as well as amylase estimation (Falling Number, FN) were evaluated. For this aim, the Czech standards (ČSN 56 0512, ČSN ISO 1871 'Kjeldahl's method', ČSN ISO 5529 and ČSN ISO 3093) were followed. Nutritional benefit of hemp addition was assessed by insoluble, soluble and total dietary fibre contents determination (IDF, SDF and TDF, respectively) by using commercial Megazyme kit (AOAC method 985 29). Baking test was performed according to internal method of ICT Prague, examining a final product characteristics (specific bread volume 'SBV', bread shape 'BRS' as height-to diameter ratio, sensorial profile 'SEN' and crumb firmness as a penetration rate 'PEN'). Sensorial quality was described by 9-point score, including attributes from overall appearance to crumb chewiness and flavour, with limits of 9 and 27 point for the best and unacceptable bread consumer's quality, respectively. For the latter test, the penetrometer PNR 10 (Petrotest, Germany) was employed. Determined repeatability as variation coefficients for the SVB and PEN are 7.1 % and 9.8 %. Cannabinoids content at four hemp plants – variety Finola. Tisza, Kompolti and Bielobrezskie (the flower and the leaf parts) were evaluated by means of GI-MS.

RESULTS AND DISCUSSION

Hemp effect on analytical composition

Basic component – wheat flour M – is characterised by higher PRO (12.5 %) with standard quality (ZT 41 ml). Estimated amyolytic activity as FN equal to 310 s corresponds to flour bakery usage and it is close to technological optimum. Related to hemp flour forms, PRO has approx. linearly increased up to about one-quarter in relation to wheat flour standard

M. The softest influence was recognized during K5 fortification, while for cereal blends containing K1 or K2 on one side and for ones with K3 and K4 on the other, approx. 4% and 7 % increments were found, respectively (Figure 1a).

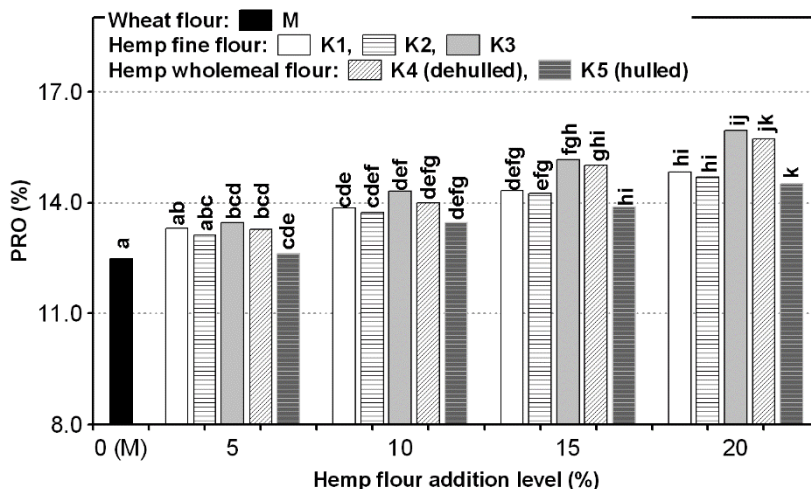

Figure 1a. Hemp form and addition level influences on protein content (PRO) in mixtures.

Reversal to content, protein quality has been significantly dwindled in all wheat-hemp flour composites in a range 7%-38%. A negative influence was milder at fortification by commercial fine hemp K1 sample. Conversely to that, verifiable loss in baking quality was registered for wholemeal hemp flour K4 or K5 hemp forms (maximal decrease of ZT about 37 %, about 68 % and 66 % for mixtures involving 20 % of non-traditional flour, respectively).

Hemp flour effect on dietary fibre (DF) content

Hemp seeds are characterised by crude fibre content approx. 25-30 % (Ruman, 2014). After dehulling and disintegration of such material brings flour with partially lowered fibre content; due to that, differences between the tested flour forms could be presumed. However, analysis of pure hemp flour samples shown only soft oscillation in determined levels, SDF, IDF and TDF varied in close extents (e.g. the former from 3.98 % to 4.39 %, the latter from 11.7 % to 12.6 %) independently on hemp flour type of form. Correspondingly, statistically diverse fibre contents were distinguished for 5 % and 20 % blends just for the TDF. A more precise discrimination of wheat hemp mixtures was identified by considering hemp form factor, although it played a secondary role compared to addition

level one. Increment of dietary fibre oscillated between 13-14 % for fine hemp blends and between 8-16 % for wholemeal ones (Figure 1b).

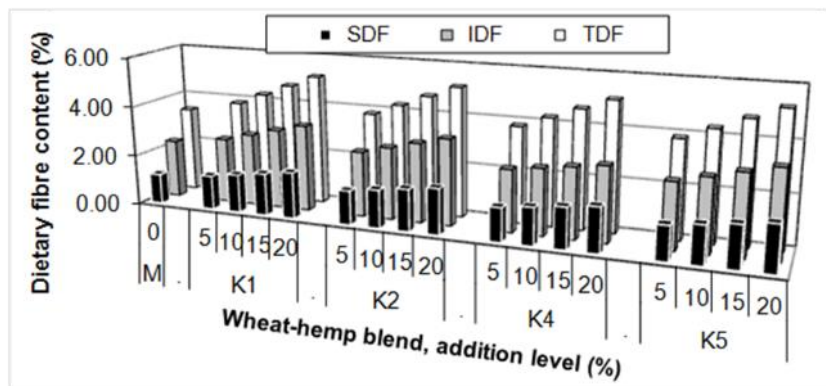

Figure 1b. Dietary fibre content in blends of wheat and hemp flour (IDF, SDF, TDF: insoluble, soluble and total dietary fibre contents, respectively)

Hemp flour effect on baking test results

Compared to wheat flour, composites involving hemp products of the Czech origin used for laboratory bread preparation were characterised by higher content of dietary fibre. Considering dough machinability, hemp products addition did not led to verifiable increase of water absorption, but they softly affected stability after optimal dough development during the farinograph test. According to mixolab results, impact of non-gluten protein groups was revealed out (Hrušková and Švec, 2015). Regardless to tested hemp type, specific volumes and shapes of breads enhanced by four domestic hemp products (K1 - K2, K4 - K5) could be considered as comparable to standard (Figure 2). The SBV worth in consumer's quality description was clearly demonstrated also within wheat/hemp composites set (Fig. 2). Value 257 mL/100g, evaluated for standard M, belongs to common bread volumes. Its vaulting (BRS) is close to empirical optimum (between 0.60 and 0.68). Also the PEN of 10.2 mm represents acceptable crumb firmness, i.e. bread chewiness.

Bakery products from composites with 5 % of fine hemp flour were characterised by still satisfying, while pieces including 20 % by unacceptable SBV (diminishing approx. about 25 %), and by worse vaulting as well as very firm crumb (PEN lower than 5.0 mm). Trends registered as a result of wholemeal hemp fortification were in opposite to ones caused by fine hemp flour, perhaps due to higher fat content. Both K4 and K5 flour improved prepared bread quality – SBV's have risen about 47 % and 38 % (9 % and 28 %) in the former and in the latter case for the lowest and the highest supplement level, respectively.

By ANOVA test, a slight interaction of hemp flour form and addition level was confirmed. Increasing rate of wholemeal hemp in recipe affected SBV, BRS and also PEN – significant differences were identified between bread including at least 10 % of hemp flour.

Sensorial scores confirmed acceptability of such fortified bread recipes for common consumers up to 10 % of hemp added. Higher hemp product dosages led to less acceptable scores, mainly owing to taste difference (partially bitter taste).

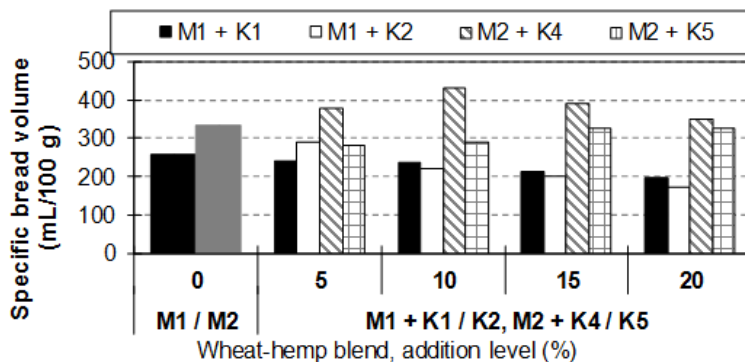

Figure 2. Specific volumes of bread with hemp products K1, K2, K4 and K5 (5-20 %)

Evaluation of hemp plant samples – cannabinoids content

Table 1. Cannabinoids content at flower (K) and leaf (L) parts of four hemp varieties

Sample	CBDA		THCA		CBD		CBN		THC	
	content (mg/kg)	+ (mg/kg)	content (mg/kg)	+ (mg/kg)	content (mg/kg)	+ (mg/kg)	content (mg/kg)	+ (mg/kg)	content (mg/kg)	+ (mg/kg)
1aK	21967	1757	482	40	385	41	1,5	0,2	58	5
1aL	7680	614	208	17	165	17	0,7	0,1	11	1
2aK	13658	1093	289	24	590	63	2,7	0,4	55	4
2aL	1669	134	126	11	65	7	0,4	0,1	10	1
3aK	29192	2335	4053	340	847	90	6,9	1,0	277	22
3aL	28253	2260	1632	137	256	7	3,0	0,4	67	5
4aK	11428	914	210	18	1122	119	2,7	0,4	90	7
4aL	4169	334	114	10	270	29	0,6	0,1	30	2

+ Uncertainty

Four varieties of *Hemp sativa* were evaluated according to content of basic cannabinoids (CBDA – cannabidiol acid, CBD-cannabidiol, CBN-cannabinol, THCA-tetrahydrocannabinol acid, THC-tetrahydrocannabinol). As is summarised (Table 1), higher content of measured cannabinoids were found in their flower parts. Amounts of CBN and THC belong to lower as expected in case of *C. culta* plants. The highest content of CBD, the most useful chemical compound for medical application, was found at the flower of variety Bialobrezskie.

CONCLUSIONS

Hemp is categorised among original plants and it has a nutritional potential for usage in food industry. Common hemp seeds render higher protein and dietary fibre content to leavened bread. For bakery products, different forms of hemp constitute a source of fortification and innovation of offered assortment. Results of the pilot study could be concluded by statement, that addition of hemp components into bakery products affects differently specific volume, shape and sensorial score of leavened bread. Also they verifiably contribute to higher contents of proteins and dietary fibre. According to our research, incorporation of hemp flour up to the level of 10 % positively affected bread sensorial properties. An addition to 20 % hemp products such as hemp flour from hulled seed can be used for bakery goods with improved nutritional profile. Leaf and flower part of *Cannabis sativa* plants content different amounts of cannabinoids, including the CBD, as the most important compound for medical application.

ACKNOWLEDGEMENTS. The research was performed under project “New Food” of the NAZV, Czech Republic, No. QI111B053.

REFERENCES

- Callaway, J. C. (2004): Hempseed as a nutritional resource: An overview. *Euphytica* 140, 65-72. <http://dx.doi.org/10.1007/s10681-004-4811-6>
- Heroudková, K. (2013): *Hemp for food and medicinal usage*, Bachelor thesis, UCT Prague. [In Czech]
- Hrušková, M., Švec, I. (2012): Pasta with hemp products addition, *Výživa a potravinářství* 2, 102-105. [In Czech]
- Hrušková, M., Švec, I. (2015): The Mixolab parameters of composite wheat/hemp flour and their relation to quality features. *LWT – Food Sci. Technol.* 60(1), 623–629. <http://dx.dio.org/10.1016/j.lwt.2014.07.034>
- Hrušková, M., Švec, I., Jurinová, I. (2011): Hemp flour usage in bakery, *Pekař a cukrář* 8, 45-47. [In Czech]
- Hurt L., Běhal L., Řehák M. (2014): Konopí. Znovu objevený potenciál, Praha, Czech Republic: Cannfest, PB tisk, 380 pp, [In Czech]
- Ruman M. (2014): *Cannabis Konopí*, Praha, Czech Republic: Mladý princ a.s., pp. 107-177, [In Czech]

EFFECT OF FORTIFICATION WITH GREEN COFFEE BEANS ON CHELATING POWER OF WHEAT BREAD

UDC 664.661 + 663.931

Urszula Gawlik-Dziki^{1*}, Dariusz Dziki², Michał Świeca¹, Agata Durak¹, Jarosław Czyż³

¹Department of Biochemistry and Food Chemistry, University of Life Sciences, Skromna Str. 8, 20-704 Lublin, Poland

*Corresponding author: urszula.gawlik@up.lublin.pl

²Department of Thermal Technology, University of Life Sciences, Doświadczalna Str. 44, 20-280, Lublin, Poland

³Department of Cell Biology, Faculty of Biochemistry, Biophysics and Biotechnology, Jagiellonian University, Gronostajowa 7, 30-387 Kraków, Poland

ABSTRACT

Phenolic compounds are able to binding the metal ions to form a complex incapable of promoting oxidation. Thus, phenolics act as “secondary” or “preventive” antioxidants. Interactions between potentially mastication extractable (BE), potentially bioaccessible (DE) and potentially bioavailable (AE) metal chelators (released during digestion *in vitro*) derived from green coffee and wholemeal wheat flour were studied. For interactions determination the isobolographic analysis was used. Results were compared with those obtained for pure chlorogenic and ferulic acids. For functional bread preparation green coffee (*Coffea arabica*) beans (GCB) and wholemeal wheat bread flour were used. Bread flour was replaced with GCB flour at 1 to 5 % levels. Taking into account the isobole shape it may be concluded that chlorogenic and ferulic acids acted antagonistically. Unexpectedly, BE and DE compounds derived from raw materials acted synergistically, whereas additive reaction was found for AE phytochemicals. GCB addition significantly enriched wheat bread with active compounds. The highest chelating power was found for AE compounds which indicates high potential bioavailability. Resignation from bread consumption for many people is impossible, thus proposed product is a compromise between “traditional” and pro-health food dedicated at this group of consumers.

Keywords: coffee, wheat bread, fortification, chelating activity, isobolographic analysis

INTRODUCTION

Iron is of considerable importance of biology mainly as component of all kinds of metalloproteins, from metalloenzymes and cytochromes to haemoglobin (Kell, 2010). On the other hand, it was suggested some years ago that iron therapy might promote the formation of hydroxyl radicals thus contributing to atherosclerosis. In connection with this, it is of importance to note that excessive accumulation of stored iron is observed in

atherosclerotic lesion as well as in brains patients with neurological diseases (Lipinski, 2011). The close relationship between iron overload and pathogenesis of chronic disease can be explained in terms of the iron-induced hydroxyl radical generation.

In the Haber-Weiss reaction hydroxyl radicals are generated in the presence of hydrogen peroxide and iron ions. The first step involves reduction of ferric into ferrous ion:



The second step is the Fenton reaction:



The requirement of hydrogen peroxide in the Fenton reaction led to the misleading concept of oxidative stress that ignores the fact that hydroxyl radical ($\bullet\text{OH}$), known to be the most biologically active free radical, is formed *in vivo* under hypoxic conditions (Michiels, 2004). Moreover, this free radical can be generated *in vitro* under the reducing condition in the presence of ascorbic acid and iron ions. Even more intriguing is a discovery of the generation of hydroxyl radicals catalyzed by ferric ions without any additional redox agent, which can be considered as a special case of the Fenton reaction (Lipinski, 2011). It was suggested, that free iron present in blood in the so called labile iron pool (Kruszewski, 2003). Thus, excessive consumption of iron-fortified foods with in combination with other factors such as some dietary supplements as well as genetic predisposition, can lead to a dangerous increase in the content of free iron in the blood. The catalytic effect of transition metal ions-induced $\text{OH}\cdot$ generation can be reduced by using molecules possessing chelating activity against these metal ions (Ramakrishna *et al.*, 2003). Iron chelators mobilize tissue iron by forming soluble and stable complexes, and then the complexes excreted in the feces and/or urine (Michiels, 2004). Currently, two iron-chelating agents are licensed for the treatment of iron overload; deferoxamine and deferiprone. Although both of the iron chelating agents has clearly established, the prices are very expensive. The prices problem induces the inconvenient route of administration therapy, and it became as significant issue (Sengoelge *et al.*, 2005).

One most effective natural antioxidants were phenolic compounds. Their antioxidant action is due to their high tendency to chelate metals. Phenolics possess hydroxyl and carboxyl groups, able to bind particularly iron and copper. They may inactivate iron ions by chelating and additionally suppressing the superoxide-driven Fenton reaction (Michalak, 2006). One of the most affluent sources of phenolics is green coffee (Farah and Donangelo, 2006), and, due their consumption cereals, especially wheat. Bread and bakery products, due to their widespread consumption are considered to be the best vehicle for functional supplements.

Thus, the aim of this work was to estimate chelating power of main phenolic components of green coffee and wheat seeds, determination of kind of interactions between them and influence on chelating power of fortified breads.

MATERIALS AND METHODS

Material

Bread flour (wholemeal flour type 2000) contained the following: protein 13.7 %, ash 1.98 %, falling number 343 s, with water absorption up to 500 BU (Brabender Units), 60.3 %. The wheat bread flour was obtained from the local milling industry, and the dried instant yeast from Instaferm® (Lallemand Iberia, SA, Setúbal, Portugal). Salt was purchased from the local market. Tap water was used in this study.

Green coffee (*Coffea arabica*) beans (GCB) (humidity 13.8 g/100g) were obtained from company Cofeina-Romuald Zalewski, Marki, Poland.

Bread preparation

The flour used in the formula of control bread (C) was wheat bread flour type 2000 (humidity 14 g/100 g). The flour was replaced with GCB flour (particles of ground CGB < 0.2 mm) at 1 g/100 g, 2 g/100 g, 3 g/100 g, 4 g/100 g, 5 g/100 g levels (GC1, GC2, GC3, GC4 and GC5, respectively). Besides this 6 g of instant yeast and 12 g of salt were used for dough preparation. The general quantity of water necessary for the preparation of the dough was established through the marking of water absorption properties in flour of a consistency of 350 Brabender units. The batches of dough were mixed in a spiral mixer for 6 min. After fermentation, the pieces of dough (300 g) were put into an oven heated up to a temperature of 230 °C. The baking time was 30 min. After baking, the bread was left to stand for 24 h at room temperature.

In vitro digestion and absorption

In vitro digestion and absorption were performed according to (Gawlik-Dziki, 2012). The samples (1g) were homogenized in a stomacher laboratory blender for 1 min to simulate mastication with the presence of 15 mL of simulated salivary fluid (prepared by dissolving 2.38 g Na₂HPO₄, 0.19 g KH₂PO₄, and 8 g NaCl, 100 mg of mucin in 1 liter of distilled water). The solution was adjusted to pH = 6.75 and α -amylase (E.C. 3.2.1.1.) was added to obtain 200 U per mL of enzyme activity). The samples were adjusted to pH = 1.2 using 5 mol/L HCl, and subsequently, 15 mL of simulated gastric fluid (300 U/mL of pepsin in 0.03 mol/L NaCl, pH= 1.2) was added. The samples were shaken for 120 min at 37 °C. After that the samples were adjusted to pH = 6 with 0.1mol/L of NaHCO₃ and then 15 mL of simulated intestinal juice (prepared by dissolving 0.05 g of pancreatin (activity equivalent 4 x USP) and 0.3 g of bile extract in 35 mL 0.1mol/L NaHCO₃ was added. The extracts were adjusted to pH = 7 with 1mol/L NaOH and finally 5 mL of 120 mmol/L NaCl and 5 ml of mmol/L KCl were added. The prepared samples were submitted for *in vitro* digestion for

60 minutes, at 37 °C in the darkness. After that samples were centrifuged and supernatants (extracts after simulated digestion) were used for further analysis.

Considering that antioxidants absorption takes place mainly at the intestinal digestion stage, fluids obtained after *in vitro* digestion was transferred to the dialysis sacks (D9777-100FT, Sigma-Aldrich), placed in an Erlenmeyer flask containing 50 mL of PBS buffer and incubated in a rotary shaker (2 times per 2 hrs, 37 °C). The PBS buffer together with the compounds that passed through the membrane was treated as an equivalent of the raw material absorbed in the intestine after digestion.

Chelating power estimation

Chelating power was determined by the method of Guo *et al.* (2001). Activity was expressed as EC₅₀ - extract concentration provided 50 % of activity based on dose-dependent mode of action. EC₅₀ value (mg/mL) is the effective concentration at which the absorbance was 0.5 for reducing power and was obtained by interpolation from linear regression analysis.

The isobolographic analysis of interactions

An isobole is an “iso-effect” curve, in which combinations of constituents are represented on a graph, the axes of which are the dose-axes of the individual agents. If the agents do not interact, the isobole (the line joining the points representing the combination of those on the dose axes representing the individual doses with the same effect as the combination) will be a straight line. If there is synergy, the dose of the combination needed to produce the same effect will be less than that for the sum of the individual components the curve is said to be ‘concave’. The opposite applies for antagonism, in which the dose of the combination is greater than expected, and produces a ‘convex’ isobole (Williamson, 2001). A sophisticated approach for interactions evaluation can be done by combination index (CI) calculations. Interaction analysis and CI values were determined using CompuSyn software version 1.0.1., ComboSyn Inc., Paramus, NJ, USA. The quantification of interaction as a synergism or antagonism was done by the general equation (Chou, 2010):

$$CI = (D_1)/(D_{50})_1 + (D_2)/(D_{50})_2 \quad (3)$$

D₁ – dose of component 1 in EC₅₀ activity of mixture, (D₅₀)₁ is EC₅₀ of component 1, D₂ – dose of component 1 in EC₅₀ activity of mixture, (D₅₀)₂ is EC₅₀ of component 2.

If CI value is equal, smaller or greater to 1, an additive, synergistic or antagonistic effect is indicated.

Statistical analysis

Statistical analysis was done at a significance level of $\alpha = 0.05$ using software Statistica 6.0, PL (Statsoft, Cracow, Poland). Measurement scores were subjected to analysis of variance (ANOVA). When significant differences in ANOVA were detected, the means were compared using the Tukey range test.

RESULTS AND DISCUSSION

We have previously demonstrated a multidirectional antioxidant activity of potentially bioaccessible and bioavailable phenolic phytochemicals from GCB. It was illustrated by their relatively high antiradical potential, metal ion chelating activity, reducing power and the ability to prevent the oxidation of lipids (Dziki *et al.*, 2015).

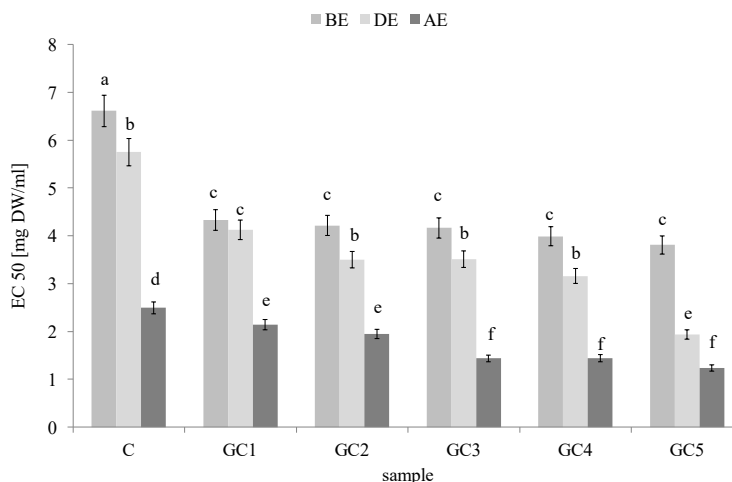

Figure 1. Effect of fortification with green coffee flour on chelating power of potentially mastication-extractable, bioaccessible and bioavailable compounds from wholemeal wheat bread; C, GC1, GC2, GC3, GC4, GC5 - control bread and bread with 1%, 2%, 3%, 4% and 5% of ground coffee bean, respectively; means with different letter superscript are significantly different ($\alpha < 0.05$)

As being presented in the Figure 1 fortification with GCB significantly enriched wheat bread with compounds able to chelate of metal ions. This tendency is particularly visible in the cases of potentially mastication-extractable and bioaccessible compounds. It should be noted that digestion *in vitro* significantly increased chelating power. Most importantly, active compounds were bioavailable *in vitro*, which may indicate their ability to prevent against Fenton reaction products.

Both ferulic and chlorogenic acids were able to metal ions chelate (EC_{50} values 63.06 g/ml and 54.15 g/ml, respectively). Taking into account isobole shape it may be concluded, that pure ferulic and chlorogenic acids interact antagonistically (Fig. 2). CI value for this interaction average 1.41 which may indicate the moderate antagonism. Importantly, green coffee flour and wholemeal wheat flour compounds able to metal ions chelate interact synergistically, as indicated by isobole curve (Fig.3). CI value (0.81) indicate on moderate synergism.

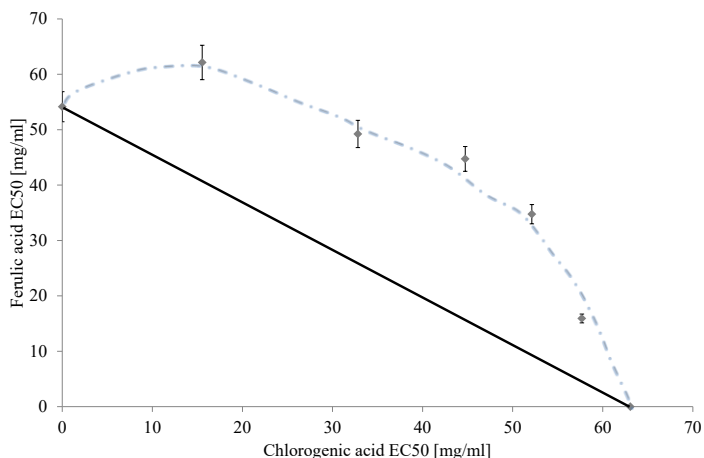

Figure 2. The isobole curve for 50 % activity of ferulic and chlorogenic acids

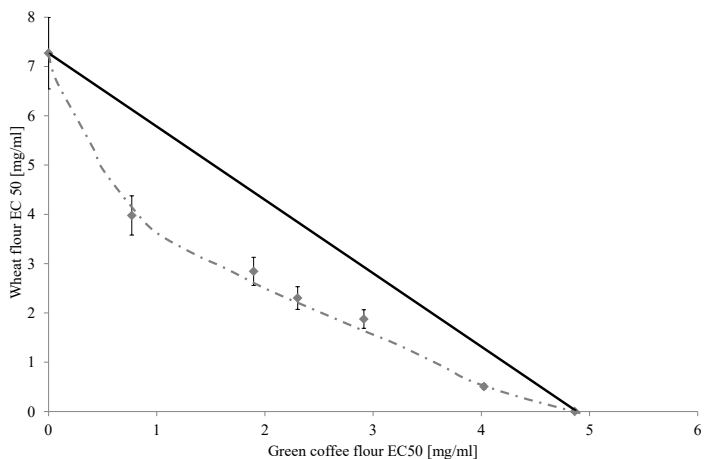

Figure 3. The isobole curve for 50 % activity of buffer extracts from green coffee and wholemeal wheat flour

Digestion *in vitro* released active compounds from both sources which may be confirmed by EC₅₀ values (2.18 and 4.74 mg/ml for green coffee and wheat flour, respectively). The kind of interaction remained unchanged, however their strength increased (CI = 0.55) (Fig.4). Unfortunately, potentially bioavailable compounds able to metal ions chelate demonstrated additive interaction, which may be suggested by isobole shape (Fig. 5). Their CI value averaged 0.97 (nearly additive).

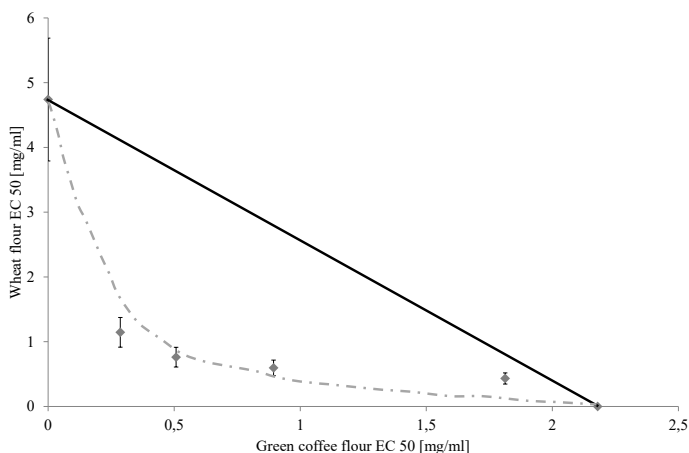

Figure 4. The isobole curve for 50 % activity of extracts obtained after digestion *in vitro* of green coffee and wholemeal wheat flour

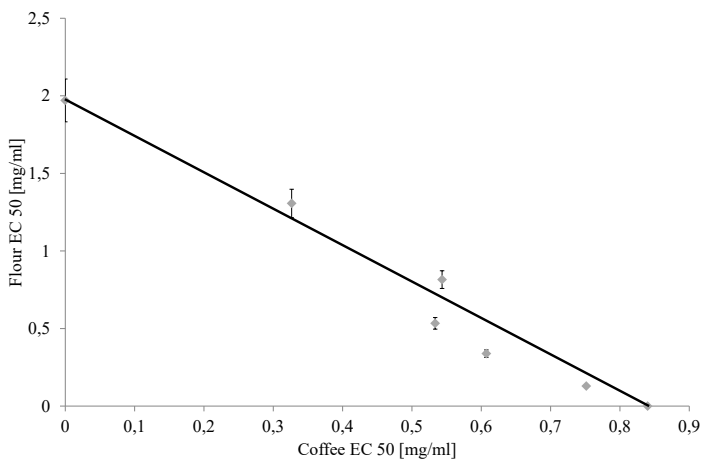

Figure 5. The isobole curve for 50 % activity of extracts obtained after absorption *in vitro* of green coffee and wholemeal wheat flour

As presented in literature, enriching bread with raw materials containing phenolic compounds increased their antioxidant potential, including the ability to metal ions chelate. This result was observed in the case of bread enriched with broccoli sprouts (Gawlik-Dziki *et al.*, 2014), quinoa leaves powder (Gawlik-Dziki *et al.*, 2015), onion skin (Gawlik-Dziki *et al.*, 2013) and preparation from green parts of buckwheat (Gawlik-Dziki *et al.*, 2009). However, in the most cases the increase of activity was not linearly correlated with the percentage of functional additive. This fact may indicate complexity of interactions between whole food components. One of the key factors determining biological activity of functional foods are the interactions between active compounds.

Recently it is emphasize that that the whole food, and particularly a combination of various natural food products, has a stronger health effect than any single biochemical or their combination (Jacobs *et al.*, 2009). So, the best way is whole foods consumption, especially since there is no complete knowledge of food composition, and some effects may result from unidentified components (di Silvestro *et al.*, 2012). In order to verify these hypothesis we decided to compare interaction between single pure chemical patterns and whole foods, which they are the main active components. As being presented in the Results section we obtained very interesting data. Another factor which significantly influenced on activity of food is digestion. Digestion fundamentally affects the activity by the release of the active compounds from the food matrix on the one hand and on the other - by enabling the creation of new connections (complexes) between matrix components and the active compounds. This thesis is confirmed by changing the type of interactions or their strength (FIG). Similar results were obtained in the case of coffee enriched with aromatic spices (Durak *et al.*, 2014; Durak *et al.*, 2014).

CONCLUSIONS

Active compounds released during digestion can be absorbed to varying degrees, which also affect their efficiency. In these study we used the simplified system simulating the passive absorption of active compounds with chelating activity and that it appears that the compounds able to penetrate the membrane are additive, whereas after simulated digestion they acted synergistically. These differences may be the result of interactions with some compounds, probably macromolecular, which were not able to penetrate through a dialysis membrane.

In conclusion, bread enriched with coffee may be a promising product to protect against ROS, especially in the gastrointestinal tract. This is very promising especially for overdose of iron from food (including the fortified or supplements). These results require further research, as well *in vivo*, however they are the first crucial step in the functional food design.

ACKNOWLEDGMENTS

The study was financed by the Polish National Science Centre (grant 2013/09/B/NZ9/01801)

REFERENCES

- Chou, T.-C. (2010): Drug combination studies and their synergy quantification using the Chou-Talalay method. *Cancer Res.* 70(2), 440–6. <http://doi.org/10.1158/0008-5472.CAN-09-1947>
- Di Silvestro, R., Marotti, I., Bosi, S., Bregola, V., Carretero, A. S., Sedej, I., Mandic, A., Sakac, M., Benedettelli, S., Dinelli, G. (2012): Health-promoting phytochemicals of Italian common wheat varieties grown under low-input agricultural management. *J. Sci. Food Agric.* 92(14), 2800–2810. <http://doi.org/10.1002/jsfa.5590>
- Durak, A., Gawlik-Dziki, U., Kowalska, I. (2015): Coffee with ginger - interactions of biologically active phytochemicals in the model system. *Food Chem.* 166, 261–9. <http://doi.org/10.1016/j.foodchem.2014.06.075>
- Durak, A., Gawlik-Dziki, U., Pecio, L. (2014): Coffee with cinnamon - impact of phytochemicals interactions on antioxidant and anti-inflammatory in vitro activity. *Food Chem.* 162, 81–8. <http://doi.org/10.1016/j.foodchem.2014.03.132>
- Dziki, D., Gawlik-Dziki, U., Pecio, Ł., Różyło, R., Świeca, M., Krzykowski, A., Rudy, S. (2015): Ground green coffee beans as a functional food supplement – Preliminary study. *LWT - Food Sci. Technol.* 63(1), 691–699. <http://doi.org/10.1016/j.lwt.2015.03.076>
- Farah, A., Donangelo, C. M. (2006): Phenolic compounds in coffee. Brazil. *J. Plant Physiol.* 18(1), 23–36. <http://doi.org/10.1590/S1677-04202006000100003>
- Gawlik-Dziki, U. (2012): Changes in the antioxidant activities of vegetables as a consequence of interactions between active compounds. *J. Funct. Foods*, 4(4), 872–882. <http://doi.org/10.1016/j.jff.2012.06.004>
- Gawlik-Dziki, U., Dziki, D., Baraniak, B., Lin, R. (2009): The effect of simulated digestion in vitro on bioactivity of wheat bread with Tartary buckwheat flavones addition. *LWT - Food Sci. Technol.* 42(1), 137–143. <http://doi.org/10.1016/j.lwt.2008.06.009>
- Gawlik-Dziki, U., Dziki, D., Świeca, M., Sęczyk, Ł., Różyło, R., Szymanowska, U., (2015): Bread enriched with Chenopodium quinoa leaves powder – The procedures for assessing the fortification efficiency. *LWT - Food Sci. Technol.* 62(2), 1226–1234. <http://doi.org/10.1016/j.lwt.2015.02.007>
- Gawlik-Dziki, U., Świeca, M., Dziki, D., Baraniak, B., Tomiło, J., Czyż, J. (2013): Quality and antioxidant properties of breads enriched with dry onion (*Allium cepa* L.) skin. *Food Chem.* 138(2-3), 1621–8. <http://doi.org/10.1016/j.foodchem.2012.09.151>
- Gawlik-Dziki, U., Świeca, M., Dziki, D., Sęczyk, Ł., Złotek, U., Różyło, R., Kaszuba, K., Ryszawy, D., Czyż, J. (2014): Anticancer and antioxidant activity of bread enriched with broccoli sprouts. *BioMed Res. Inter.* 2014, 608053. <http://doi.org/10.1155/2014/608053>
- Guo, J. T., Lee, H. L., Chiang, S. H., Lin, F. I., Chang, C. Y. (2001): Antioxidant Properties of the Extracts from Different Parts of Broccoli in Taiwan. *J. Food Drug Anal.* 9(2), 96–101. <http://www.scopus.com/inward/record.url?eid=2-s2.0-0347625077&partnerID=tZOTx3y1>
- Jacobs, D. R., Gross, M. D., Tapsell, L. C. (2009): Food synergy: an operational concept for understanding nutrition. *Am. J. Clin. Nutr.* 89(5), 1543S–1548S. <http://doi.org/10.3945/ajcn.2009.26736B>
- Kell, D. B. (2010): Towards a unifying, systems biology understanding of large-scale cellular death and destruction caused by poorly liganded iron: Parkinson's, Huntington's, Alzheimer's, prions, bactericides, chemical toxicology and others as examples. *Archiv. Toxicol.* 84(11), 825–89. <http://doi.org/10.1007/s00204-010-0577-x>
- Kruszewski, M. (2003): Labile iron pool: the main determinant of cellular response to oxidative stress. *Mutat. Res./Fund. Mol. M.* 531(1-2), 81–92. <http://doi.org/10.1016/j.mrfmmm.2003.08.004>

- Lipinski, B. (2011): Hydroxyl radical and its scavengers in health and disease. *Oxidat. Med. Cel. Long.* 2011, 1–9. <http://doi.org/10.1155/2011/809696>
- Michalak, A. (2006): Phenolic Compounds and Their Antioxidant Activity in Plants Growing under Heavy Metal Stress. *Plant Cell*, 15(4), 523–530. <http://www.pjoes.com/pdf/15.4/523-530.pdf>
- Michiels, C. (2004): Physiological and pathological responses to hypoxia. *Am. J. Pathol.* 164(6), 1875–82. [http://doi.org/10.1016/S0002-9440\(10\)63747-9](http://doi.org/10.1016/S0002-9440(10)63747-9)
- Ramakrishna, G., Rooke, T. W., Cooper, L. T. (2003): Iron and peripheral arterial disease: revisiting the iron hypothesis in a different light. *Vasc. Med.* 8(3), 203–210. <http://doi.org/10.1191/1358863x03vm493ra>
- Sengoelge, G., Sunder-Plassmann, G., Hörl, W. H. (2005): Potential risk for infection and atherosclerosis due to iron therapy. *J. Renal Nutr.* 15(1), 105–110. <http://doi.org/10.1053/j.jrn.2004.09.018>
- Williamson, E. M. (2001): Synergy and other interactions in phytomedicines. *Phytomed.* 8(5), 401–9. <http://doi.org/10.1078/0944-7113-00060>

THE CORRELATION OF BUCKWHEAT GRAIN PHENOLIC COMPOUNDS WITH RESISTANCE TO MYCOTOXINS

UDC 633.11 : 615.9

Ilona Keriene^{1*}, *Audrone Mankeviciene*¹, *Saulius Bliznikas*², *Danutė Jablonskyte-Rasce*¹, *Sigita Janaviciene*¹, *Ruta Cesnuleviciene*¹

¹Lithuanian Research Centre for Agriculture and Forestry, Instituto Ave.1, Akademija, Lithuania

*Corresponding author: ilona.keriene@gmail.com

²Institute of Animal Science, Lithuanian University of Health Sciences,
R. Zebenkos 12, Baisogala, Lithuania

ABSTRACT

One widely-investigated alternative solution to mycotoxin problem is to search for natural compounds with a proven antifungal power. The current study was aimed to determine the concentration of mycotoxins and phenolic compounds in organic buckwheat grain and to statistically substantiate if higher concentrations of phenolic compounds had influence on mycotoxin concentrations in natural conditions. The chemical compounds, characterised by antifungal properties, extracted from buckwheat grain were quantified and identified and mycotoxins deoxynivalenol (DON), T2 toxin (T2), aflatoxin B1 (AFL B1) and ochratoxin A (OCH A) were determined in the samples. Research showed that all buckwheat grain samples were contaminated by the investigated toxins. AFL B1 concentration was $5.1 \pm 1.0 \mu\text{g kg}^{-1}$ and 2.5 times exceeded the requirements of the EU regulation. The regression-correlation analysis between mycotoxins and buckwheat phenolic compounds showed that the content of DON significantly decreased with increasing total phenolic content (correlation coefficient $r = -0.867$, $P < 0.01$), rutin ($r = -0.702$, $P < 0.05$) and 3,4 -dihydroxybenzoic acid concentration ($r = -0.765$, $P < 0.01$). Ochratoxin A concentration decreased with increasing concentration of rutin ($r = -0.635$, $P < 0.05$) and *p*-hydroxybenzoic acid ($r = -0.635$, $P < 0.05$). This implies the occurrence of interactions of the phenolic compounds with mycotoxins which may reduce their overall effectiveness.

Keywords: organic buckwheat grain, mycotoxin, phenolic compounds, correlation.

INTRODUCTION

Fungal infections and toxicity of mycotoxins are one of the causes of contamination of important agricultural commodities; therefore this problem is associated with our daily life. Since complete removal of mycotoxins from food is not possible, it is necessary to search for antifungal agents which may provide an alternative way to prevent fungal contamination of food. Buckwheat (*Fagopyrum Esculentum* Moench) is a good source of phenolic compounds, such as rutin and quercetin (Fabjan *et al.*, 2003; Sedej *et al.*, 2010; Keriene *et al.*, 2015). They contain a wide range of generally found esterified or bound to

cell wall phenolic acids, which help to preserve stability of processed products in food industry and may account for about one-third of the phenolic compounds in our diet (Lattanzio *et al.*, 2006; Teixeira, 2013). Phenolic compounds play an important role in growth and reproduction of plants, their content depends on the phenological stages and provide protection against pathogens (Beekrum *et al.*, 2003; Fabjan *et al.*, 2003; Lattanzio *et al.*, 2006, Mankevičienė *et al.*, 2014; Samapundo *et al.*, 2007). The toxicity of phenolic compounds to pathogens is dependent on phenolic compounds structural features and is related to the presence of hydroxyl function(s) in the aromatic structure, which evidences that increased hydroxylation results in increased toxicity (Lattanzio *et al.*, 2006; Cowan, 1999; Teixeira *et al.* 2013). Various antifungal compounds are used in the prevention of fungi and mycotoxin accumulation in different plant species (Samapundo *et al.*, 2006; Thanaboripat, 2011; Sumalan *et al.*, 2013). The current study was aimed to determine the concentration of mycotoxins and phenolic compounds in buckwheat grain and to statistically substantiate if higher concentrations of phenolic compounds have influence on mycotoxin concentrations.

MATERIAL AND METHODS

Organic production of buckwheat grains were collected from Lithuanian regions and examined for total phenolics, rutin and quercetin contents. Six phenolic acids (*p*-hydroxybenzoic, 3,4-dihydroxybenzoic, *p*-coumaric, ferulic, vanillic and sinapic) were quantified and identified. The fungal infection was estimated and identified and mycotoxins deoxynivalenol (DON), T2 toxin (T2), ochratoxin A (OCH A), aflatoxin B1 (AFL B1) concentrations were determined. Analysis of mycotoxins and phenolic compounds (total and individual) were done at Institute of Agriculture, Lithuanian Research Centre for Agriculture and Forestry in 2014.

Preparation of extracts

All samples were milled in an IKA A11 Basic mill ("Staufen", Germany) and stored at +4°C until analysis. Mycotoxin extraction was performed according to manufacturer's instructions. DON extraction was performed according to the Neogen Europe *Ltd* (Scotland). Immunoaffinity NeoColumn for the quantification of DON was used. AFL B1, T2 and OCH A were extracted according to the R-Biopharm Ridascreen® (Germany Darmstadt) instruction.

Total phenolic content, rutin and quercetin were detected by the method reported by Mikašauskaitė *et al.* (2013) with slight modification. Samples (2.500 ± 0.001 g) were extracted with 75% (v/v) aqueous methanol (25.0 ± 0.1 mL) at room (21 ± 1 °C) temperature for 15 hours in a shaker incubator Tu-400 (MRC, Israel) under constant shaking. The mixtures were centrifuged ("Hermle", Germany) for 10 min at 4000 rpm. Phenolic acids were extracted according to Kvasnička *et al.* (2008). One gram (±0.001 g) of ground sample was weighed and 25.0 ± 0.1 ml of 0.1 M NaOH added, shaken in a water bath Memmert WNB 14 ("Memmert", Germany) at 40 °C for 60 minutes, cooled to room temperature, acidified with 2 M HCl to pH 5–6 and 20.0 ± 0.1 ml of methanol was added. The flask was

placed in an ultrasonic bath (Bandelin Electronic, Germany) for 30 minutes, cooled to room temperature and made up to volume with methanol. The filtrate after filtration by 0.22 µm membrane filter (Frisenette ApS, Denmark) was analysed by HPLC.

Chemicals and reagents

All the chemicals were of analytical grade and were used as received. For extraction, methanol HPLC LiChrosolv[®], acetonitrile LiChrosolv[®] (MERCK, Germany) were used. Deoxynivalenol standard, sodium carbonate, Folin-Ciocalteu reagent, acetic acid, sodium hydroxide, hydrochloric acid and mix of seven phenolic acids (*p*-hydroxybenzoic, 3,4-dihydroxybenzoic, *p*-coumaric, ferulic, vanillic, sinapic) standards were purchased from Sigma-Aldrich (Germany). Most of the reagents used for the determination of mycotoxins by ELISA method were contained in the Ridascreen[®] test kit (Biopharma, Darmstadt (Germany)). Deionized water with resistivity of 18.2 MΩ was generated by a Mili-Q plus system (Milipore, USA).

Mycotoxin and phenols assay methods

Analysis of T2, OCH A, AFL B1 was carried out using an Enzyme Linked Immunoassay (ELISA) commercial kit Ridascreen[®] (R-Biopharm AG, Germany). A photometer Multiskan MS with 450 nm light filter was used for results reading. The results were processed by a computer programme Ascent Software. The method is approved by the AOAC Research Institute (Certificate N 950702).

A Shimadzu high performance liquid chromatography (HPLC) system was employed for determination of deoxynivalenol, phenolic acids, rutin and quercetin content and consisted of the following modules: system controller SBM-20A, auto injector SIL-20A, UV-Vis detector SPD-20A, low pressure gradient flow control valve LC-20AT, column oven CTO-20A, on-line degasser DGU-20As. Data collection and evaluation was performed by using operating system LCsolution Workstation ("Shimadzu", Japan). DON was separated by the method described by MacDonalds *et al.* (2005). Phenolic acids were separated by the method described by Amarowicz and Weidner (2001). Rutin and quercetin were separated by the method described by Fabjan *et al.* (2003). The chromatographic conditions are given in the Table 1.

Total phenolic content (TPC) was determined using Folin-Ciocalteu reagent as the method described by Sedej *et al.* (2010) with some modifications. TPC was conducted by mixing 7.9 mL of deionized water, 100 µL extract, 0.5 mL Folin-Ciocalteu and 1.50 mL 20% sodium carbonate (after 6 min at room temperature) was added. The absorbance (after 120 min) was measured at 760 nm using a UV/VIS spectrophotometer PerkinElmer LAMBDA 25 ("PerkinElmer", USA). A standard curve (0.05–1.5 mg mL⁻¹) was prepared with rutin. Final results were expressed as µg of rutin eq. g⁻¹ dry weight (d.w.).

Table 1. HPLC conditions

Condition	Deoxynivalenol	Rutin, quercetin	Phenolic acids
Mobile phase, v/v/v	water:acetonitrile:methanol 450:25:25	methanol:water: acetic acid 100:150:5	A - methanol B - water:acetonitrile:acetic acid. 88:10:2
Elution	Isocratic	Isocratic	Gradient: 100% B (4 min), 0 to 100% A (15 min), holding 100% A 10 min, decrease to 0% A in 0.5 min; holding 100% B 6.5 min.
Flow rate, ml/min	1.5	1.0	1.0
Column RP-18	Inertsil ODS 3 150 × 4.6 mm, 5µm	LiChrospher 100 250 × 4.6 mm, 5µm	LiChrospher 100 250 × 4.6 mm, 5µm
Column oven temperature, °C	40	30	30
Injection volume, µl	100	10	10

Statistical Analysis

Buckwheat grain samples were analysed in triplicate (analysis of mycotoxins AFL B1, T2, OCH A were repeated twice) and expressed as a mean ± standard deviation (SD) of *Microsoft Office Excel 2007* ("Microsoft", USA). The Correlation & Regression type of analysis were performed in order to examine the quantitative relationship between investigated compounds. Results with values $P < 0.01$ and $P < 0.05$ were considered significant. Statistical analysis was calculated by using the packages a *STAT ENG* from software *SELEKCIJA* (Tarakanovas, Raudonius, 2003).

RESULTS AND DISCUSSION

In 2014, contamination of buckwheat grain with *Fusarium* spp. fungi accounted for 58.6 ± 5.6 % of the total fungal infection. Evaluation of the species composition showed *F. graminearum* species to account for 13 % of the total *Fusarium* spp. contamination. Buckwheat grain was lightly contaminated with *Aspergillus* spp. and *Penicillium* spp. fungi; however, *A. flavus* species was detected. Consequently DON, T2, AFL B1 and OCH A toxins were analysed. Research showed that all samples tested were contaminated by the investigated toxins (Table 2). The concentrations of DON and OCH A did not exceed the allowable limits set forth in the Regulation (EC) No.1881/2006 and T2 toxin levels did not exceed the recommended limits either.

Table 2. The concentration of mycotoxins in buckwheat grain

Mycotoxins, $\mu\text{g kg}^{-1}$	Mean \pm SD	Min.	Max.	Variation coef., %
<i>Deoxynivalenol</i>	157 \pm 68	70.0	302	43.5
<i>T2 toxin</i>	38.0 \pm 4.8	32.2	45.2	12.8
<i>Aflatoxin B1</i>	5.1 \pm 1.0	2.2	8.4	35.2
<i>Ochratoxin A</i>	1.9 \pm 0.4	1.1	2.6	21.0

Mean \pm standard deviation

Table 3. The concentration of phenolic compounds in buckwheat grain

Phenolic compounds	Concentration, $\mu\text{g g}^{-1}$ d.w.	The percentage distribution
		<u>of the total phenolic content</u>
<i>Rutin</i>	344.7 \pm 8.5	3.0
<i>Quercetin</i>	4.7 \pm 0.2	0.04
<i>Total phenolic content</i>	11579 \pm 1117	100
		<u>of the total phenolic acids content</u>
<i>3,4-DHBA</i>	50.0 \pm 3.4	59.5
<i>p-HBA</i>	17.7 \pm 0.9	21.1
<i>Vanillic acid</i>	0.6 \pm 0.8	0.7
<i>p-Coumaric acid</i>	8.6 \pm 1.3	9.8
<i>Ferulic acid</i>	4.4 \pm 1.2	5.2
<i>Sinapic acid</i>	2.8 \pm 1.1	3.4
<i>Total six phenolic acids content</i>	84.1 \pm 6.5	100

Mean \pm standard deviation; d.w. – dry weight; 3,4-DHBA- 3,4-dihydroxybenzoic acid; p-HBA – p-hydroxybenzoic acid.

The concentration of AFL B1 in all buckwheat grain samples exceeded the allowable limits of the EU regulation. It is likely that environmental conditions increased the likelihood of mould growth and synthesis of mycotoxins. The year 2014 in Lithuania was adverse for buckwheat cultivation. The spring and June were cool and wet, and because of a sudden rise in temperatures in July, buckwheat started to experience shortage of moisture, they wilted and withered before reaching complete maturity. Favourable conditions for the spread of fungi of *Penicillium* and *Aspergillus* genera were created. According to Guo *et al.* (2008), drought stress is a major factor to contribute to preharvest aflatoxin contamination. But it is probable that the low concentrations of DON were affected by phenolic compounds which provide antifungal activity. The reduction of contamination by *Fusarium* spp. of buckwheat grain after exposure to phenolic compounds was

demonstrated in our previous *in vitro* antifungal studies (Mankevičienė *et al.*, 2014). In the present study we investigated three groups of phenolic compounds in buckwheat grain: flavonoids (rutin, quercetin), hydroxybenzoic acids (*p*-hydroxybenzoic, 3,4-dihydroxybenzoic and vanillic) and hydroxycinnamic acids derivatives (*p*-coumaric, ferulic and sinapic acids) (Table 3). The statistically validated results of the correlation between the concentrations of mycotoxins and phenolic showed that samples with higher concentrations of phenolic compounds contained lower concentrations of DON and OCH A.

Regression-correlation analysis showed that DON content in buckwheat grain significantly decreased with increasing total phenolic content: the correlation coefficient $r = -0.867$, $P < 0.01$ (Fig. 1a). It is likely that rutin plays an important role in this process (3% of total phenolic content). The samples with higher concentrations of rutin had lower concentrations of DON and OCH A. The correlation coefficient was $r = -0.702$ ($P < 0.05$) and $r = -0.635$ ($P < 0.05$), respectively. In buckwheat grain, quercetin concentration was up to 40 times lower than that of rutin, and their contents correlated in buckwheat grains ($r = 0.730$, $P < 0.01$), but the interaction between quercetin and mycotoxins was not established. Sumalan *et al.* (2013) have proved that various essential oils significantly positively correlated ($r = 0.94$) with the total phenolic content and had influence on decreasing of DON and fumonisin concentration in wheat seeds.

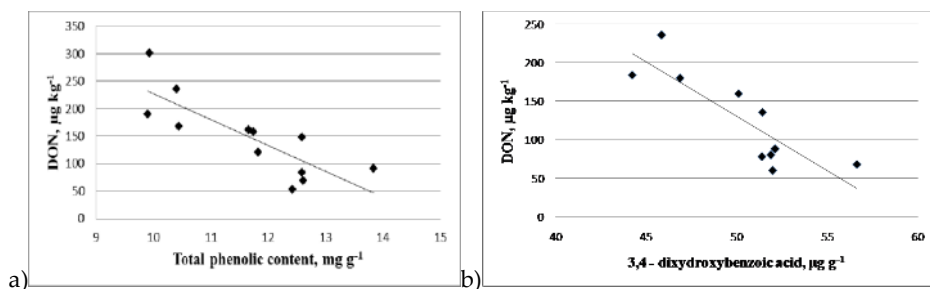

Figure 1. DON concentration correlation with: a) total phenolic content $r = -0.867$, $P < 0.01$
b) 3,4-dihydroxybenzoic acid concentration, $r = -0.765$, $P < 0.01$.

The analysis of phenolic acids showed that 3,4-dihydroxybenzoic acid (3,4-DHBA) and *p*-hydroxybenzoic acid (*p*-HBA) predominated in buckwheat grain and together accounted for 80.6% of the total phenolic acids content. The inhibitory effect of 3,4-DHBA on DON was identified, $r = -0.765$, $P < 0.01$ (Fig. 1b), and a negative correlation of *p*-HBA with OCH A content was detected ($r = -0.635$, $P < 0.05$). 3,4-DHBA is very important for plants since it provides disease resistance (Lattanzio *et al.*, 2006). Vanillic acid occurred at the lowest concentration in buckwheat grain compared with other phenolic acids and its effect on mycotoxins was not detected. However, Samapundo *et al.* (2007) reported that vanillic

acid content had influence on AFL B1 concentration in corn. The sum of hydroxycinnamic acid derivates accounted for 18.4% of the total phenolic acids, but the correlation with mycotoxins was not detected either. They are known as potent antioxidants (Teixeira *et al.*, 2013).

The regression-correlation analysis between the AFL B1 toxin and phenolic compounds suggested that the AFL B1 concentrations increased parallel to the increasing of total phenolic content $r = 0.846$, $P < 0.01$ (Fig 2a). Individual phenolic acids, which show the significant reduction of DON and OCH A (3,4-DHBA, *p*-HB) exhibited an opposite effect on AFL B1 and T2 toxin. Phenolic compounds are thought to act as not inhibitors, but on the contrary, they can stimulate the synthesis of mycotoxins. Thanaboripat (2011) indicated that various medicinal plants extracts affected AFL producing fungi and AFL: lower concentrations of phenolic compounds of essential oils extracted from cloves and cinnamon stimulated synthesis of *Aspergillus* spp. and higher concentrations of phenolic compounds inhibited the mycelium growth of fungi.

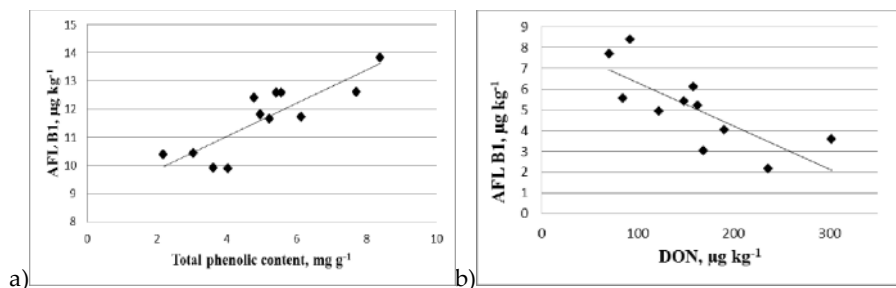

Figure 2. The correlation between: a) AFL B1 and total phenolic content $r = 0.846$, $P < 0.01$
b) AFL B1 and DON concentrations, $r = -0.759$, $P < 0.01$.

We also found a correlation between the AFL B1 and DON concentrations in buckwheat grain, when the correlation coefficient was $r = -0.759$, $P < 0.01$ (Fig. 2b). This leads to the assumption that mycotoxins can correlate among themselves; however, it is still unclear what factors governed this correlation. It is likely that low concentrations of DON and OCHA in combination with favourable weather conditions create more conducive conditions to AFL B1 and T2 synthesis. Therefore, natural prevention is one of the best methods for controlling fungi and mycotoxins contamination.

CONCLUSIONS

All buckwheat grain samples were contaminated by the DON, OCH A, T2 and AFL B1 toxins. The concentration of AFL B1 in buckwheat grain samples exceeded the allowable limits (Regulation (EC) No.1881/2006) by 2.5 times ($5.1 \pm 1.0 \mu\text{g kg}^{-1}$). We statistically

proved that effect of organic buckwheat grain phenolic compounds on mycotoxins may reduce their overall effectiveness. The regression-correlation analysis showed that the content of DON significantly decreased with increasing content of total phenolics (correlation coefficient $r = -0.867$, $P < 0.01$), rutin ($r = -0.702$, $P < 0.05$) and 3,4 - dihydroxybenzoic acid ($r = -0.765$, $P < 0.01$). Ochratoxin A level decreased with increasing concentration of rutin ($r = -0.635$ ($P < 0.05$) and *p*-hydroxybenzoic acid ($r = -0.635$, $P < 0.05$). Phenolic compounds which show significantly reduces of DON and OCH A (3,4-DHBA, *p*-HB) exhibited an opposite effect on AFL B1 and T2 toxin.

ACKNOWLEDGEMENTS

The study was supported by the Research Council of Lithuania Project No. SVE-04/2014.

REFERENCES

- Amarowicz, R., Weidner, S. (2001): Content of phenolic acids in rye caryopses determined using DAD-HPLC method, *Czech J. Food Sci.*; 19, 201-205.
- Beekrum, S., Govinden, R., Padayachee, T., Odhav B. (2003): Naturally occurring phenols: a detoxification strategy for fumonisin B1, *Food Additives & Contaminants*, 20, 490-493.
- Cowan, M. M. (1999): Plant Products as Antimicrobial Agents, *Clinical Microbiology Reviews*, 12 (4), 564-582. [cmr.asm.org](http://dx.doi.org/10.1155/2013/251754)
- Fabjan, N., Rode, J., Košir, I. J., Wang, Z., Zhang, Z., Kreft, I. (2003): Tartary buckwheat (*Fagopyrum tataricum* Gaertn.) as a source of dietary rutin and quercitrin, *J Agric Food Chem*, 5, 6452-6455. <http://dx.doi.org/10.1155/2013/251754>.
- Guo, B., Chen, Z.-Y., Dewey Lee, R. D., Scully, B. T. (2008): Drought Stress and Preharvest Aflatoxin Contamination in Agricultural Commodity: Genetics, Genomics and Proteomics, *Journal of Integrative Plant Biology*, 50, 1281-1291.
- Kerienė I., Mankevičienė A., Bliznikas S., Jablonskytė-Raščė D., Maikštėnienė S., Česnulevičienė R. (2015): Biologically active phenolic compounds in buckwheat, oats and winter spelt wheat, *Zemdirbyste-Agriculture*, 102(3), 289-296.
- Kvasnička, F., Čopiková, J., Ševčík, R., Krátká, J., Syntytsia, A., Voldřich, M. (2008): Determination of phenolic acids by capillary zone electrophoresis and HPLC, *Cent Eur J Chem*, 6, 410-418.
- Lattanzio, V., Lattanzio, V. M., Cardinali, A. (2006): Role of phenolics in the resistance mechanisms of plants against fungal pathogens and insects. In: *Phytochemistry: Advances in Research*, Filippo Imperato (ed.), Kerala, India: Research Signpost, pp. 23-67.
- MacDonald, S. J., Chan, D., Brereton, P. (2005): Determination of deoxynivalenol in cereals and cereals products by immunoaffinity column cleanup with liquid chromatography: Interlaboratory study. *J AOAC Int*, 88, p. 1197.
- Mankevičienė, A., Kerienė, I., Butkutė, B., Česnulevičienė, R. (2014): *In vitro* antifungal effect of phenolic compounds against *Fusarium* spp. infection on buckwheat grain. In: The 3rd International conference on Plant Metabolism, Xiamen, China, pp. 122.

- Mikašauskaitė, J., Ragažinskienė, O., Maruška, A. (2013): Variation of total amount of phenolic compounds, radical scavenging activity and volatile compounds of *Liriodendron tulipifera* L. and *Ginkgo biloba* L. leaves extracts during different vegetation periods, *Biologija*, 59, 175–186.
- Samapundo, S., De Meulenaer, B., Osei-Nimoh, D., Lamboni, Y., Debevere, J., Devlieghere, F. (2007): Can phenolic compounds be used for the protection of corn from fungal invasion and mycotoxin contamination during storage?, *Food Microbiology*, 24, 465 – 473.
- Sedej, I. J., Sakač, M. B., Mišan, A. Č., Mandić, A. I. (2010): Antioxidant activity of wheat and buckwheat flours, *Zb Matise srp prir nauke*, 118, 59–68.
- Sumalan, R.-M., Ersilia, A., Poiana, M.-A. (2013): Assessment of inhibitory potential of essential oils on natural mycoflora and Fusarium mycotoxins production in wheat, *Chemistry Central Journal*, 7, 1-12. <http://journal.chemistrycentral.com/content/7/1/32>
- Tarakanovas, P., Raudonius S. (2003): Agronominių tyrimų duomenų statistinė analizė taikant kompiuterines programas ANOVA, STAT, SPLIT-PLOT iš paketo SELEKCIJA ir IRRISTAT. Lithuanian University of Agriculture., pp. 58 (in Lithuanian).
- Teixeira, J., Gaspar, A., Garrido, E. M., Garrido, J., Borges, F. (2013): Hydroxycinnamic acid antioxidants: an electrochemical overview, *BioMed Res Int.*, 1–11.
- Thanaboripat, D. (2011): Control of Aflatoxins in Agricultural Products using Plant Extracts, *KMITL Sci Tech J*, 11, 35–42.

QUALITY AND ANTIOXIDANT PROPERTIES OF BREAD ENRICHED WITH FLOUR OBTAINED FROM ELICITED WHEAT SEEDLINGS

UDC 664.661.2

Urszula Gawlik-Dziki^{1*}, Dariusz Dziki², Michał Świeca¹, Łukasz Sęczyk¹

¹Department of Biochemistry and Food Chemistry, University of Life Sciences, Skromna Street 8, 20-704 Lublin, Poland

*Corresponding author: dariusz.dziki@up.lublin.pl

²Department of Thermal Technology, University of Life Sciences, Doświadczalna Street 44, 20-280 Lublin, Poland

ABSTRACT

The aim of present work was to evaluate the influence of sprouted flour addition, obtained from elicited wheat seeds, on quality and antioxidant properties of wheat bread. Sprouted flour (SF) was obtained from four-day germinated wheat (*Triticum aestivum*, ssp. *vulgare*, cv. Bogatka). Germination was performed in darkness at 20 °C. Before germination seeds were placed in distilled water contained 0.1 % *Salix daphnoides* bark extract for 6 h at 25 °C. Seedlings were dried at 80 °C at to the moisture level 14 % (wb) and ground. The samples studied were wheat flour (control) and SF. The flour was replaced with SF at 5 g, 10 g, 15 g and 20 g of sprouted flour/100 g wheat flour. The farinograph properties of dough were evaluated. A straight-dough method was used in an experimental baking test. The textural properties of bread crumb (TPA test) and the sensory analysis were used for bread quality evaluation. Generally the addition of sprouted flour into wheat flour up to 10 % had no significant influence on water absorption, development time, stability and degree of softening. Higher share of SF caused a decrease of water absorption and a slight decrease of development time and stability of dough, whereas degree of softening slightly increased. The results showed that bread enriched with sprouted flour with a share up to 10 g of SF/100 g wheat flour had no negative influence both of texture determined by TPA test and on sensorial properties. Higher level of SF in bread recipe caused a decrease crumb cohesiveness and springiness, and slight increase of crumb hardness. Besides, bread enriched with SF was characterized by stronger antioxidant properties in comparison to control sample.

Keywords: sprouted flour, elicitation, bread, quality, antioxidant properties

INTRODUCTION

Enrichment of food products with functional components has been commonly used in order to enhance their pro-health properties. Cereal food products in developed communities provide more than 50 % of the total energy intake, are considered to be the best vehicle for functional supplements (Akhtar *et al.*, 2011). Especially bread and bakery products have an important role in human nutrition. Generally, wheat bread is considered

to be a good source of energy and irreplaceable nutrients for the human body. However many bioactive compounds found in the grain, especially phenolic compounds, are particularly concentrated in the bran and aleurone layer. Phenolic acids are the main antioxidants in cereal grains, which seem to have the greatest potential to be beneficial to our health as a result of their scavenging free radicals, inhibition of lipid peroxidation, and thus their anticancer activity (Mateo Anson *et al.*, 2011). Generally, bread made with patent wheat flour is a food with a low antioxidant capacity (Gunenc *et al.*, 2013). Hung *et al.* (2009) showed that the antioxidant activity of white flour is three times lower than that of wholemeal flour. The presence of a large number of bioactive compounds undoubtedly gives whole grain wheat bread great potential in terms of health benefits. However, this bread type is not acceptable everywhere, and besides this the bran can include many impurities, such as heavy metals, pesticides and microorganism (Mousia, *et al.*, 2004; Samar *et al.* Castillo, 2003).

The second way to increase the health-promoting properties of bread based on enrichment of bread flour with functional components. Currently, there are some successful trials concerning the improvement of the nutraceutical potential of bread via enrichment by different food plant materials (Dziki *et al.*, 2014). An interesting future trend can be the supplementation of wheat bread in flour from sprouted cereals and pseudocereals. Germination has been acknowledged as a cost-effective technology and as it causes considerable changes in the nutritional characteristics of seeds (Viswanathan and Ho, 2014). Sprouted seeds are desirable from a nutritional point of view and nutritionally superior compared with non-sprouted seeds (Khattak *et al.*, 2007). Enrichment of the seeds in deficient micronutrients during sprouting may create a multifunctional additive to supplement the human diet (Diowksz *et al.*, 2014). Flour obtained from sprouted wheat can be used for making many of valuable for health products (Shingare and Thorat 2014). Additionally the nutraceutical potential of sprouted seeds can be enhanced by elicitation. Elicitation is one of the effective methods used to enhance secondary metabolite production in numerous plant systems (Baenas *et al.*, 2014). So far, infusions of willow bark (a source of salicylic acid – plant hormone) is known to be effective inducers of antioxidant synthesis in broccoli and wheat seeds (Gawlik-Dziki *et al.*, 2013, Dziki *et al.*, 2015). Thus the aim of present study was to examine the influence of sprouted flour addition, obtained from elicited wheat seeds, on quality and antioxidant properties of bread.

MATERIALS AND METHODS

Materials

Bread flour (white flour type 750) contained the following: protein 11.7 %, ash 0.76 %, falling number 287 s and water absorption 54 %. The wheat bread flour was obtained from the local milling industry, and the dried instant yeast from Instaferm® (Lallemand Iberia, SA, Setúbal, Portugal). Salt was purchased from the local market. Tap water was used in this study.

Sprouted flour (SF) was obtained from four-day germinated wheat seeds (*Triticum aestivum*, ssp. *vulgare*, cv. Bogatka). Germination was performed in darkness at 20 °C. Before germination seeds were placed in distilled water contained 0.1% *Salix daphnoides* bark extract for 6 h at 25 °C. The conditions of germination and elicitation were chosen on the basis of previous study (Dziki *et al.*, 2015). Seedlings were dried at 80 °C at to the moisture level 14 % (wb) and ground using the laboratory knife mill GRINDOMIX GM 200 (RETSCH, Germany, Hann). The wholemeal flour from sprouted wheat (particles below 0.35 mm) was used for bread supplementation.

Bread preparation

A straight-dough method was used in an experimental baking test (Różyło, 2014). The samples studied were wheat flour (control) and SF. The flour was replaced with SF at 5 g, 10 g, 15 g and 20 g of sprouted flour/100 g wheat flour (SF1, SF2, SF3 and SF4, respectively). Besides, the ingredients used (g/100 g flour) were instant dry yeast (1 g/100 g), salt (1.5 g/100 g) and water (the amount necessary to obtain dough consistency 350 FU). In the straight dough baking method, the loaves of bread were prepared after dough mixing (8 min) in a slow-speed mixer type GM-2, fermenting and proofing the dough in a fermentation cabinet (ICH 256, Memmetr, Germany, Dusseldorf). The dough was fermented at 30 °C and 75–80 % relative humidity (RH) for 60 min (with 1-min transfixion after 30 min of resting). After the end of fermentation, a piece of dough was weighed, divided into loaves of equal mass (300 g) and formed, and then subjected to proofing performed at 30 °C and 75 % RH in the time required for optimal dough development. The rule was applied that if, after a light depression of the dough, the surface the dough returned to its original position, it meant insufficient development of the dough, while if a slight indentation remained on its surface, it meant the optimal dough development. The loaves were baked at 230 °C for 25 min in a laboratory oven (Sadkiewicz Instruments, Poland, Bydgoszcz). Live steam was injected for 0.5 min immediately after the loaves were placed in the oven. Baking tests were performed in three replicates. After baking, the bread was cooled for 3 h at room temperature (21 °C) and then wrapped in polyethylene bags.

Farinograph tests

The behavior of the dough prepared during development and mixing was tested with the help of Farinograph-E equipped with mixer S 50 with sigma blades for 50 g of flour (model 810114, Brabender, Duisburg, Germany). According to the standard procedure (ICC 115/1) the following farinograph indices were determined: water absorption, development time, stability and the degree of softening of dough. The procedure was performed in triplicate.

Bread evaluation

The physical properties of the bread were determined one day after baking. The samples were evaluated for bread loaf volume from 100 g of flour was calculated (Różyło, 2014). The moisture of crumb was determined by AACC Method 44-15.02. These assays were performed in triplicate. The textural properties of bread crumb (TPA test) were evaluated

with the help of the ZWICK Z020/TN2S strength tester. In this study the bread crumb samples (cylinders with 22 mm diameter and 14 mm high) were compressed using a capital equipped with a 30 mm plug until a 60 % depth at the crosshead speed of 1 mm/s. The samples were compressed twice to give a two-bite, from which textural parameters were obtained: hardness, springiness, cohesiveness and chewiness (Gámbaro *et al.*, 2006). Crumb texture measurements were made in six replicates, on samples cut from the middle part of the loaves. Sensory evaluation was carried out on bread samples with the different percentages of SF. Subsequently, the samples were sliced (slices about 1.5 cm thick), coded with a number and served to untrained consumers. The panel consisted of 34 consumers (24–55 years old), who evaluated the bread's overall acceptability. This hedonic test was used to determine the degree of overall liking for the different types of bread based on degree of liking or disliking according to a nine-point hedonic scale (1: dislike extremely, 5: neither like nor dislike, 9: like extremely). Plain water was used for mouth rinsing before and after each sample testing (Lim *et al.*, 2011).

Reducing power estimation

Powdered samples of breads (1g) were extracted for 30 min. with 20 mL of methanol : water mixture (1:1, v/v), pH = 2. The extract was separated by decantation and the residue was extracted again with 20 mL of solvent. Extracts were combined and stored in darkness at -20°C. Reducing power was based on the method used by Oyaizu (1984) method. The absorbance at 700 nm was measured. Increased absorbance of the reaction mixture indicated increased reducing power. The test was performed in triplicate.

Statistical analysis

Statistical analysis was done at a significance level of $\alpha = 0.05$ using software Statistica 6.0, PL (Statsoft, Cracow, Poland). Measurement scores were subjected to analysis of variance (ANOVA). When significant differences in ANOVA were detected, the means were compared using the Tukey range test.

RESULTS AND DISCUSSION

Farinograph properties of the dough samples supplemented with different levels of the SF are presented in Table 1. The addition of SF into wheat flour caused a slight decrease of flour water absorption from 59.6 % for control sample to 57.3 % for bread with SF4. However the SF addition up to 10 % had no significant influence of this parameter. Similar influence of SF addition on others farinograph parameters was observed. Generally the addition of sprouted flour into wheat flour up to 10 % had no significant influence on development time, stability and degree of softening. The 15 % and 20 % replacement of wheat flour by SF caused only a slight decrease of development time and stability of dough, whereas degree of softening slightly increased. This results are generally in agreement in the results obtained by Kaur *et al.* (2002). They also showed decrease of development time and dough stability with SF addition into wheat flour and little influence of SF addition on water absorption.

Table 1. Farinograph properties of wheat dough enriched with sprouted flour

Sample	Water absorption (%)	Development time (min)	Stability (min)	Degree of softening (FU)
C*	59.6±0.58 ^{a**}	2.5±0.21 ^b	4.9±0.43 ^c	103±0.41 ^{ab}
SF1	59.4±0.53 ^a	2.4±0.35 ^b	4.8±0.38 ^{bc}	102±1.36 ^a
SF2	58.6±0.72 ^{ab}	2.5±0.24 ^b	4.6±0.41 ^{bc}	102±2.52 ^a
SF3	57.9±0.44 ^b	2.1±0.16 ^a	4.5±0.25 ^{ab}	104±0.95 ^b
SF4	57.3±0.81 ^{bc}	1.9±0.18 ^a	4.3±0.11 ^a	106±2.73 ^c

C*, SF1, SF2, SF3, SF4 - control bread and bread with 5%, 10%, 15%, and 20% of sprouted flour from elicited wheat, respectively,

**Means with different letter superscript within a same row are significantly different ($\alpha < 0.05$)

Table 2. Volume, moisture and the texture properties of bread

Sample	Hardness [N]	Cohesiveness	Springiness [mm]	Chewiness [N]	Moisture [% wb]
C*	8.5±1.2 ^{a**}	0.68±0.08 ^d	6.5±0.13 ^e	37.6±3.7 ^d	42.3±0.21 ^c
SF1	9.2±0.8 ^{ab}	0.64±0.09 ^d	6.3±0.08 ^d	37.1±4.1 ^{cd}	41.8±0.15 ^b
SF2	9.4±1.1 ^{bc}	0.58±0.06 ^c	6.1±0.11 ^c	33.3±3.8 ^c	41.6±0.27 ^a
SF3	10.3±1.3 ^c	0.45±0.07 ^b	5.5±0.10 ^b	26.7±2.1 ^b	41.9±0.13 ^a
SF4	11.8±1.5 ^d	0.37±0.04 ^a	4.9±0.09 ^a	22.1±2.8 ^a	41.5±0.33 ^a

C*, SF1, SF2, SF3, SF4 - control bread and bread with 5%, 10%, 15% and 20% of sprouted flour from elicited wheat, respectively;

**Means with different letter superscript within a same row are significantly different ($\alpha < 0.05$)

The results of bread quality parameters were presented in table 2. The moisture of bread ranged from 41.5 % for bread with SF4 to 42.3 % for control bread. Generally SF addition into wheat flour had little influence on crumb moisture. The preparation of bread with SF3 and SF4 caused a slight decrease of bread volume, whereas addition of SF up to 10 % into wheat flour (samples SF1 and SF2) had no significant influence of this parameter. The results obtained by Kaur *et al.* (2002) also showed that addition of SF up to 10 % into wheat flour had no significant influence of loaf volume. The hardness of bread crumb slightly increased with SF addition, from 8.5 N for control bread to 11.8 N for SF4 bread, whereas cohesiveness, springiness and chewiness decreased as a result replacement of wheat flour by SF.

The sensory attributes were significantly influenced by SF addition. Especially when 15 % and 20 % of SF was added the irregularity of crumb pores was observed. Besides, the SF 3 and SF4 breads were less elastic, and little sprung back after compression and the crumb was sticky and wet. Thus, the lower notes for texture were obtained. The SF addition had

no significant influence on bread aroma and color acceptability and had little influence on bread taste (Table 3). Generally, replacement of wheat flour by SF up to 10 % had no negative influence on bread overall acceptability.

Table 3. Sensory evaluation of bread prepared by the substitution of wheat flour with sprouted flour*

Attribute	C**	SF1	SF2	SF3	SF4
Color	7.6±0.25 ^{a***}	7.9±0.37 ^a	7.8±0.76 ^a	7.4±0.44 ^a	7.6±0.23 ^a
Aroma	8.4±0.34 ^a	8.3±0.25 ^a	8.2±0.58 ^a	8.2±0.36 ^a	8.0±0.67 ^a
Texture	7.3±0.36 ^a	7.2±0.54 ^a	6.9±0.62 ^{ab}	5.4±0.28 ^a	4.8±0.47 ^{ab}
Taste	7.4±0.42 ^a	7.3±0.29 ^a	6.7±0.38 ^a	6.5±.15 ^{ab}	6.4±0.39 ^b
Overall	7.7±0.31 ^a	7.7±0.66 ^a	7.4±0.64 ^a	6.8±0.65 ^b	6.6±0.58 ^b

*Nine-point hedonic scale with 1, 5 and 9 representing extremely dislike, neither like nor dislike, and extremely like, respectively,

C*, SF1, SF2, SF3, SF4 - control bread and bread with 5%, 10%, 15% and 20% of sprouted flour from elicited wheat, respectively,

***Means with different letter superscript within a same row are significantly different ($\alpha < 0.05$).

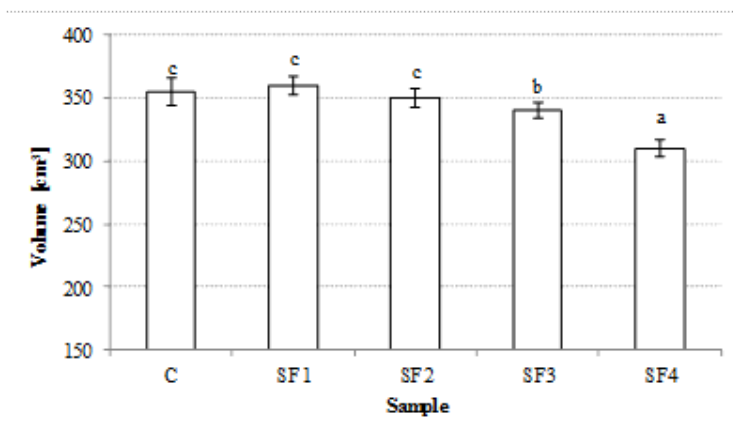

Figure 1. The volume of bread enriched with sprouted flour (C, SF1, SF2, SF3, SF4 - control bread and bread with 5%, 10%, 15%, and 20% of sprouted flour from elicited wheat, respectively; means with different letter superscript within a same row are significantly different ($\alpha < 0.05$))

The reducing capacity of a compound may serve as a significant indicator of its potential antioxidant activity (Nadaroglu *et al.*, 2007). As being presented in the Fig. 1 addition of sprouted flour significantly enriched bread with reductive compounds. The increase of activity was positively correlated with the percentage of additive.

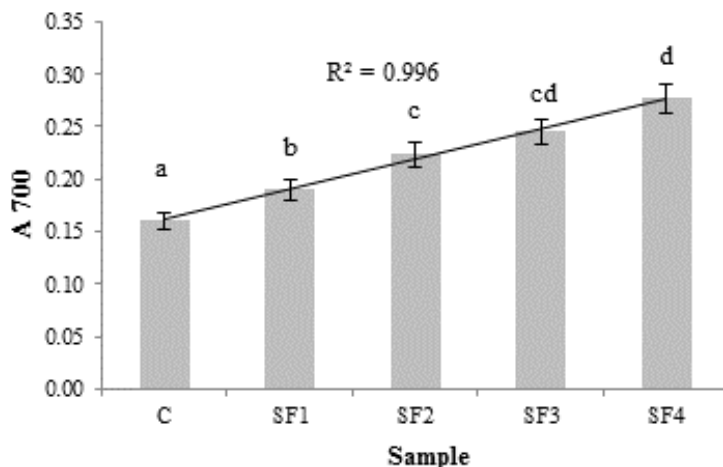

Figure 2. Reducing power of control and enriched bread, The volume of bread enriched with sprouted flour (C, SF1, SF2, SF3, SF4 - control bread and bread with 5 %, 10 %, 15 % and 20 % of sprouted flour from elicited wheat, respectively; means with different letter superscript within a same row are significantly different ($\alpha < 0.05$))

There is little work on the enriching of bread with sprouted seeds. Gawlik-Dziki *et al.* (2014) showed that bread enriched with broccoli sprouts is a valuable source of potentially bioaccessible and bioavailable low-molecular antioxidants with anticancer properties. Ertaş (2015) studied technological and chemical characteristics of breads made with lupin sprouts and found that bread supplemented with 3 day sprouted lupin flour gave superior technological and nutritional properties compared to the control sample.

CONCLUSIONS

The results showed that enriching of bread with sprouted flour, obtained from elicited wheat with a share up to 10 g of SF/100 g wheat flour had no negative influence both of texture properties determined by TPA test and on sensorial quality. Higher level of SF in bread recipe resulted a decrease of loaves volume and caused sticky and wet crumb. Besides, crumb cohesiveness and springiness decreased. From the other hand, the positive linear correlation was found between SF addition and reducing power of bread.

ACKNOWLEDGMENTS

Authors acknowledge the financial support of the Polish National Science Centre (Grant 2012/07/B/NZ9/02463).

REFERENCES

- Akhtar, S., Anjum, F.M., Anjum, M.A.A. (2011): Micronutrient fortification of wheat flour: recent development and strategies, *Food Res. Int.* 44, 652–659. <http://dx.doi.org/10.1016/j.foodres.2010.12.033>
- Baenas, N., Garcia-Viguera, C., Moreno, D.A. (2014): Elicitation: a tool for enriching the bioactive composition of foods, *Molecules*, 19, 13541–13563. <http://dx.doi.org/10.3390/molecules190913541>
- Diowski, A., Kordialik-Bogacka, E., Ambroziak, W. (2014): Se-enriched sprouted seeds as functional additives in sourdough fermentation. *LWT- Food Sci. Technol.* 56, 524–528. <http://dx.doi.org/10.1016/j.lwt.2013.11.023>
- Dziki, D., Gawlik-Dziki, U., Kordowska-Wiater, M., & Domań-Pytka, M. (2015): Influence of elicitation and germination conditions on biological activity of wheat sprouts, *Journal of Chemistry*. <http://dx.doi.org/10.1155/2015/649709>
- Dziki, D., Różyło, R., Gawlik-Dziki, U., Świeca, M. (2014): Current trends in the enhancement of antioxidant activity of wheat bread by the addition of plant materials rich in phenolic compounds. *Trends Food Sci. Tech.* 40, 48–61. <http://dx.doi.org/10.1016/j.tifs.2014.07.010>
- Ertas, N. (2015): Technological and chemical characteristics of breads made with lupin sprouts. *Qual. Assur Saf. Crop*, 7, 313–319. <http://dx.doi.org/10.3920/QAS2013.0347>
- Gambaro, A., Gimenez, A., Ares, G., Gilardi, V. (2006): Influence of enzymes on the texture of brown pan bread, *J. Texture Stud.* 37, 300–314. <http://dx.doi.org/10.1111/j.1745-4603.2006.00053.x>
- Gawlik-Dziki, U., Świeca, M., Dziki, D., Sęczyk, Ł., Złotek, U., Różyło, R., Kaszuba K, Ryszawy D., Czyz, J. (2014): Anticancer and antioxidant activity of bread enriched with broccoli sprouts. *BioMed Resarch International*, <http://dx.doi.org/10.1155/2014/608053>
- Gawlik-Dziki, U., Świeca, M., Dziki, D., Sugier, D. (2013): Improvement of nutraceutical value of broccoli sprouts by natural elicitors. *Acta. Sci. Pol-Hortoru.* 12, 129-140.
- Gunenc, A., Tavakoli, H., Seetharaman, K., Mayer, P. M., Fairbanks, D., Hosseini, F. (2013): Stability and antioxidant activity of alkylresorcinols in breads enriched with hard and soft wheat brans. *Food Res. Int.* 51, 571–578. <http://dx.doi.org/10.1016/j.foodres.2013.01.033>
- <http://dx.doi.org/10.5897/AJB10.066>
- Hung, P. V., Maeda, T., Miyatake, K., & Morita, N. (2009): Total phenolic compounds and antioxidant capacity of wheat graded flours by polishing method. *Food Res. Int.* 42, 185–190. <http://dx.doi.org/10.1016/j.foodres.2008.10.005>
- Kaur, K., Singh, N., Singh, H. (2002): Studies on the effect of skim milk powder, sprouted wheat flour, and pH on rheological and baking properties of flour. *Int. J. Food Prop.* 5, 13–24. <http://dx.doi.org/10.1081/JFP-120015589>
- Khattak, A. B., Zeb, A., Bibi, N., Khalil, S. A., Khattak, M. S. (2007): Influence of germination techniques on phytic acid and polyphenols content of chickpea (*Cicer arietinum* L.) sprouts. *Food Chem.* 104, 1074–1079. <http://dx.doi.org/10.1016/j.foodchem.2007.01.022>

- Lim, H. S., Park, S. H., Ghafoor, K., Hwang, S. Y., Park, J. (2011): Quality and antioxidant property of bread containing turmeric (*Curcuma longa* L.) cultivated in South Korea. *Food Chem.* 112, 1577–1582. <http://dx.doi.org/10.1016/j.foodchem.2010.08.016>
- Mateo Anson, N., Aura, A. M., Selinheimo, E., Mattila, I., Poutanen, K., van den Berg, R., Havenaar, R., Bast, A., Haenen, G.R. (2011): Bioprocessing of wheat bran in whole wheat bread increases the bioavailability of phenolic acids in men and exerts anti-inflammatory effects *ex vivo*. *J. Nutr.* 141, 137–143. <http://dx.doi.org/10.3945/jn.110.127720>
- Mousia, Z., Edherly, S., Pandiella, S. S., & Webb, C. (2004): Effect of wheat pearling on flour quality, *Food Res. Int.* 37, 449–459. <http://dx.doi.org/10.3945/jn.110.127720>
- Nadaroğlu, H., Demir, Y., Demir, N. (2007): Antioxidant and radical scavenging properties of *Iris germanica*. *Pharm. Chem. J.* 41(8), 409–415. <http://dx.doi.org/10.1007/s11094-007-0089-z>
- Oyaizu, M. (1984): Studies on products of browning reaction – antioxidative activities of products of browning reaction prepared from glucosamine. *Japan J. Nutr.* 44, 307–315.
- Rózyło, R. (2014): Effect of process modifications in two cycles of dough mixing on physical properties of wheat bread baked from weak flour. *Food Bioprocess Tech.* 7, 774–783. <http://dx.doi.org/10.1007/s11947-013-1100-1>
- Samar, M. M., Ferro Fontan, C., Resnik, S., Pacin, A., Castillo, M. (2003): Distribution of deoxynivalenol in wheat, wheat flour, bran, and gluten, and variability associated with the test procedure. *J. AOAC Int.* 86, 551–556.
- Shingare, S.P., Thorat, B.N. (2014): Fluidized bed drying of sprouted wheat (*Triticum aestivum*), *Int. J. Food Eng.* 10, 29–37. <http://dx.doi.org/10.1515/ijfe-2012-0097>
- Viswanathan, K., Ho, P. (2014): Fortification of white flat bread with sprouted red kidney bean (*phaseolus vulgaris*). *Acta Sci.Pol. Technol. Aliment.* 13, 27–34.

INFLUENCE OF GERMINATION TIME ON GRINDING CHARACTERISTICS AND ANTIOXIDANT ACTIVITY OF SPROUTED WHEAT

UDC 633.11 : 664.64.016.8

Dariusz Dzik^{1*}, *Urszula Gawlik-Dziki*², *Marek Domin*³, *Katarzyna Kozłowicz*³,
*Zbigniew Krzysiak*⁴

¹*Department of Thermal Technology, University of Life Sciences,
Doświadczalna Street 44, 20-280 Lublin, Poland*

**Corresponding author: dariusz.dziki@up.lublin.pl*

²*Department of Biochemistry and Food Chemistry, University of Life Sciences,
Skromna Street 8, 20-704 Lublin, Poland*

³*Department of Refrigeration and Food Industry Energetic,
Doświadczalna Street 44, 20-280 Lublin, Poland*

⁴*Department of Mechanical Engineering and Automatics, University of Life Sciences in Lublin,
Głęboka 28, 20-612 Lublin, Poland*

ABSTRACT

Sprouting may be regarded as a natural bioreactor or biotechnological module and could be used to improve the nutrition value in food products. During sprouting, some seed reserves are degraded and used for synthesis of new cell constituents for the developing embryo, thereby causing significant changes in the biochemical, nutritional, and sensory characteristics of the cereals.

The aim of present study was to examine the influence of germination time on grinding characteristics of the sprouted wheat kernels and the antioxidant properties of wholemeal flour. Several studies have been carried out of three cultivars of common wheat (*Triticum aestivum*, ssp. *vulgare*). The wheat seeds germinated for 2, 4, 6 and 8 days and dried up at 80 °C to 14 % moisture content (w.b.). The dried sample were pulverized by using a knife mill. The free radicals scavenging activity and ferric reducing power of sprouted flour were also determined. The results showed that the sprouting of wheat had a significant influence on the grinding process. The average particle size of the pulverized material obtained from the sprouted kernels was significantly lower than those from the sound kernels. The increase the time of sprouting caused a decrease in the value of specific grinding energy in all cultivars. In addition, the other values of grinding energy indices confirmed that sprouting significantly reduced the grinding energy requirements. Sprouting also caused an increase the antioxidant potential of wheat seedlings, especially for antiradical activity.

Keywords: wheat, germination, elicitation, grinding, antioxidant properties

INTRODUCTION

Wheat is one of the most important cereal crops in the world and its presence is ubiquitous in the food cultures of many countries. The wheat grain provides for much of the world's dietary protein and food supply. Especially whole wheat products contain high amount of nutritional compounds such as dietary fiber, resistant starch, vitamins, minerals, and microconstituents, which help to reduce the risks of many disease (Hung *et al.*, 2011).

Seed germination is a complex process involving various physical and biochemical cues such as water, light and phytohormones (Xu *et al.*, 2011). During wheat processing germination has been reported to adversely affect the milling and baking quality of wheat. Especially the high amylolytic and proteolytic activity will not allow producing good quality bread from sprouted flour (Lorenz and Valvano, 2006). From the other hand sprouted seeds in comparison to sound seeds contain higher level of numerous vitamins, secondary plant ingredients, enzymes, mineral nutrients, and trace materials. Sprouted flour is easier to digest by the human body than the regular flour; moreover, it contains less starch and more protein (Chavan and Kadam, 1989) and increases bioavailability of minerals as a result of phytate reduction ability (Hemery *et al.*, 2007, Larsson and Sandberg, 2006). Additionally wheat sprouting positively influences on the biological activity of seedlings and enhancement of antioxidant activity of sprouted wheat can be obtained by seeds elicitation (Dziki *et al.*, 2015). Flour obtained from sprouted wheat can be used for making many of valuable for health products, such as noodles, pasta, laddu, unleavened bread, porridge and gruels for newborns (Shingare and Thorat 2014).

Size reduction is one of the most important process in cereal processing. Among all the properties of the wheat kernel, its mechanical properties have the most significant influence on the grinding process. These properties are further affected by many factors, such as, genetic heritage, the conditions required for growth, the water content of the kernel. The mechanical properties of the wheat kernel also change due to its sprouting (Miś and Grundas, 2002). Only a limited information is available concerning the wholemeal grinding of sprouted seeds. (Dziki and Laskowski, 2010, Dziki *et al.*, 2015a). The time of sprouting has significant influence on biological activity of wheat seedlings (Dziki *et al.*, 2015b) and thus can modify the end use of sprouted flour.

The aim of present study was to examine the influence of germination time on grinding characteristics and antioxidant properties of the sprouted wheat.

MATERIALS AND METHODS

Materials

Investigations were carried out on three Polish winter wheat cultivars (*Triticum aestivum* ssp. vulgare): Bogatka, Mulan, and Muszelka. The seeds came from the field experiment conducted in 2013 at experimental station belonging to the Lublin Agricultural Advisory Center in Końskowola. The detailed seeds characteristics was included in the work of Dziki *et al.* (2015a). Before germination, seeds were sterilized in 1 % (v/v) sodium hypochlorite for 10 min and then drained and washed with distilled water until they

reached a neutral pH. The seeds were placed in distilled water contained of 0.1 % (v/v) *Salix daphnoides* bark extract for 6 h at 25 °C. Elicitor was prepared as follows. Bark of *S. daphnoides* (obtained from ecological farm, Poland) was dried and extracted with boiling water at concentration of 0.1 % (w/v). The seeds were germinated for 2, 4, 6, and 8 days in a controlled incubator (ICH 256, Memmert, Düsseldorf, Germany). Germination was carried out at 20 °C in darkness. Sprouts were convective dried at 80 °C up to the moisture level 14 % (wb) using a laboratory dryer (MSL-07, Promis-Tech, Poland) with an air flow rate of 1.0 m·s⁻¹.

Grinding process

The sprouted and the sound kernels (50 g samples) were ground by using the Retsch laboratory knife mill GRINDOMIX GM 200. The time of grinding was 1.0 min with the revolution of knife 7000 min⁻¹. The changes occurring in the values of power consumption of the electric current during the grinding process were recorded with the frequency of 200 Hz by using the laboratory equipment, including the grinding machine, the transducer of power, and a special data acquisition card, PCL818 L, connected to a computer (Dziki *et al.*, 2014). The sieving test was used to determine the distribution of the ground material. Sieving was carried out for 5 min, by using a laboratory screen Thyr 2, and separated into nine fractions using sieves of sizes, 1600, 1000, 800, 630, 500, 400, 315, and 200 µm. On the basis of the particle size, the average particle size (d) were calculated (Velu *et al.*, 2006):

$$d = \sum_{i=1}^n \phi d_i, \text{ mm} \quad (1)$$

where ϕ represents the differential weight fraction (kg·kg⁻¹) of particles passing through the aperture size d_i (mm).

The specific grinding energy was determined as the ratio of the grinding energy to the mass of the material taken for grinding. The grinding efficiency index was calculated as a ratio of the surface area of the ground material to the grinding energy. The surface area of the pulverized material was evaluated according to the procedure described by Velu *et al.* (2006). The grinding index (K_s) was calculated on the basis of the size reduction theory described by Sokołowski (1996).

Antioxidant properties evaluation

Extracts preparation

500 mg of powdered sprouts samples were extracted with 5 ml of PBS buffer (buffer extract). Samples were shaken during 30 min and centrifuged (13000 g, 10 min). Procedure was repeated three times. Collected supernatants were used for biochemical analysis.

Free radicals scavenging assay

The experiments were performed using an improved ABTS decolorization assay (Re, *et al.*, 1999). ABTS^{••} was generated by the oxidation of ABTS with potassium persulfate. The ABTS radical cation (ABTS^{••}) was produced by reacting 7 mM stock solution of ABTS with 2.45 mM potassium persulphate (final concentration). The ABTS^{••} solution was diluted (with distilled water) to an absorbance of 0.7 ± 0.05 at 734 nm. Then, 40 μ L of samples were added to 1.8 mL of ABTS^{••} solution and the absorbance was measured at the end time of 5 min. The ability of the extracts to quench the ABTS free radical was determined using the following equation:

$$SC = [(AC - AA) / AC] \times 100 \% \quad (2)$$

where, SC - scavenging, %, AC – absorbance of control, AA – absorbance of sample.

Antiradical activity was expressed as EC₅₀ - extract concentration provided 50 % of activity based on dose-dependent mode of action.

Ferric reducing power assay

Reducing power was determined using the method described by Oyaizu (1986). Extracts (2.5 mL) were mixed with phosphate buffer (2.5 mL, 200 mM, pH 6.6) and 2.5 mL of 1 % aqueous solution of potassium ferricyanide K₃[Fe(CN₆)]. The mixture was incubated at 50 °C for 20 min. A portion (0.5 mL) of 10 % trichloroacetic acid was added to the mixture, which was then centrifuged at 25 x g for 10 min. The upper layer of solution (2.5 mL) was mixed with distilled water (2.5 mL) and 0.5 mL of 0.1 % FeCl₃, and the absorbance was measured at 700 nm. Reducing ability was expressed as EC₅₀ (mg/mL) - the effective concentration at which the absorbance was 0.5 for reducing power and was obtained by interpolation from linear regression analysis.

Statistical analysis

The data were subjected to a statistical analysis and the consequent evaluations were analyzed for a variance analysis. The statistical differences were estimated through Tukey's test. Statistical tests were evaluated by using the Statistica 6.0 software (StatSoft, Inc., Tulsa, USA). All the statistical tests were carried out at a significance level of $\alpha = 0.05$.

RESULTS AND DISCUSSION

The average particle size (d) of the ground material obtained from the sprouted kernels was almost always significantly lower ($P < 0.05$) than the one obtained from the sound wheat kernels (Fig. 1). As the time of tempering increased the d decreased (average from 0.51 mm to 0.43 mm). This tendency was observed for each cultivar. Similar grinding pattern was observed for individual wheat samples. The lowest values of d were observed for Bogatka cv., whereas the values of this parameter for Muszelka and Mulan were similar and significantly higher. Among all the properties of wheat, the mechanical properties of the kernels have the greatest influence on the distribution of the particle size, especially, on the finest fractions (Greffeuille *et al.*, 2006). The soft kernels of wheat fracture more easily and release many intact granules of starch, thus causing less damage to the starch. However, the hard kernels of wheat produce particles of a coarse texture in which the ruptured planes produce broken starch granules causing higher levels of damage to the starch (Letang *et al.*, 2001). Further, Miś and Grundas (2002) showed that sprouting causes a significant decrease in the hardness of the wheat kernels. This could be the reason that during the grinding process of spouted wheat a higher degree of comminution is observed. Similar tendency was also recently found by Dziki *et al.* (2015a) during grinding of four day sprouted wheat by hammer mill.

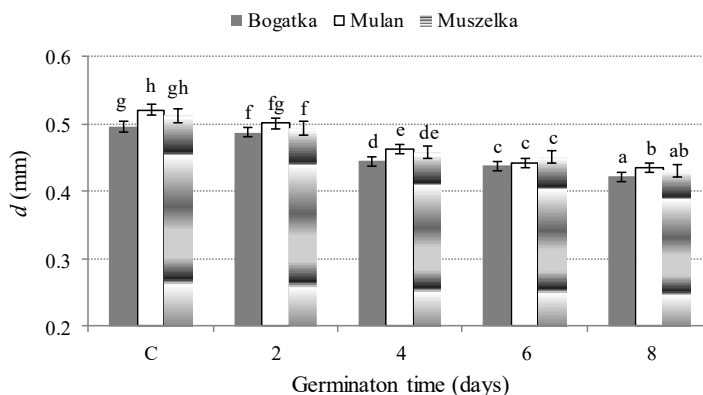

Figure 1. Influence of wheat germination time on average particle size of ground seedlings (the values designated by the different letters are significantly different ($\alpha = 0.05$))

The relation between the d of sprouted wheat and time of germination (τ_g) for tested cultivars of sprouted wheat can be described as follow:

$$d = -0,0105 \tau_g + 0,509; R^2 = 0,908 \quad (3)$$

The results showed that sprouting caused a significant decrease ($P < 0.05$) in the value of the specific grinding energy (E_r) in all cultivars. Based on the germination time the average values of E_r ranged from $31.2 \cdot 10^{-1} \text{ kJ} \cdot \text{kg}^{-1}$ for control what before germination to $15.7 \text{ kJ} \cdot \text{kg}^{-1}$ for sprouted wheat (Fig. 2). The highest value of E_r were obtained for Mulan and Muszelka samples and the slightly lower E_r was found for Bogatka wheat. The increase of germination time caused for all cultivars the decrease of E_r . This is caused by the physicochemical changes during seed germination. The enzymatic action and the changes that occur during sprouting probably cause a lower adhesion between the protein matrix and the starch granules. Besides this, germination results in the formation internal cracks in the endosperm region of the sprouted kernel but not in that of the sound kernel (Neethirajan *et al.*, 2007).

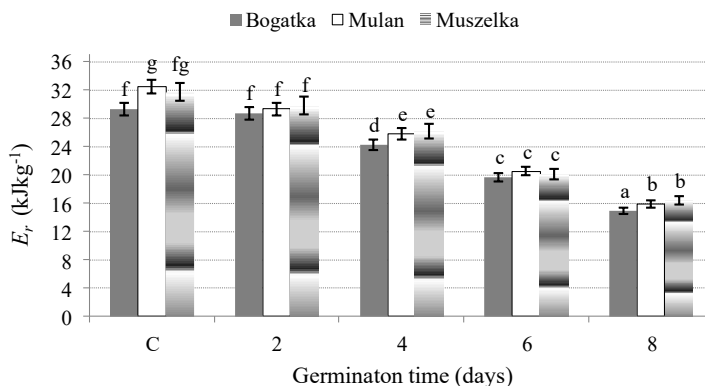

Figure 2. Influence of wheat germination time on specific grinding energy of seedlings (the values designated by the different letters are significantly different ($\alpha = 0.05$))

The relation between the E_r of sprouted wheat and time of germination (T_g) for tested cultivars of sprouted wheat can be described as follow:

$$E_r = 2,002 \tau_g + 32,34; R^2 = 0,958 \quad (4)$$

The evaluation results of the grinding efficiency index (E_f) are presented in Fig. 3. This parameter takes into account the effectiveness of the grinding process and it is defined as the quotient the surface of the ground material to the grinding energy. The grinding process was found to be the most effective in the sprouted wheat germinated during 8 days. As the sprouting time increased the values of E_f increased too. The highest values of this index were obtained in the case of Bogatka. The values of E_f for Muszelka and Mulan were significantly lower.

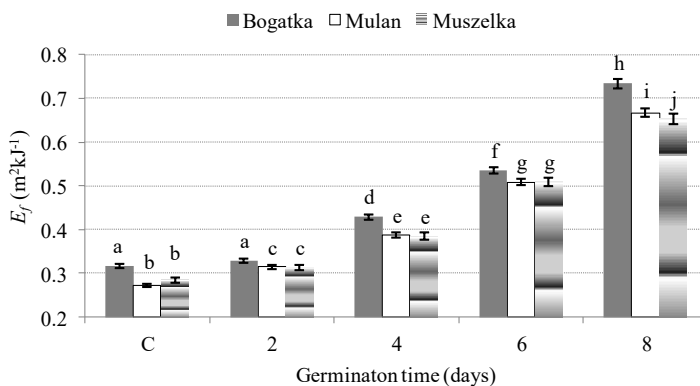

Figure 3. Influence of wheat germination time on grinding efficiency index of seedlings (the values designated by the different letters are significantly different ($\alpha = 0.05$))

Sprouting caused a significant decrease ($P < 0.05$) in the value of the grinding index (K_s) for all cultivars (Fig. 4). This tendency was noted to be similar to the changes in the values of E_r (Fig. 1). As the germination time increased the values of this index decreased (average from $37.9 \text{ kJkg}^{-1}\text{mm}^{0.5}$ to $16.6 \text{ kJkg}^{-1}\text{mm}^{0.5}$) and this was found for seedlings of all tested cultivars. Dziki and Laskowski (2010) and Dziki *et al.* (2015a) used hammer mill for grinding characteristics of sprouted wheat kernels and they also found lower values of K_s for three-day and four-day sprouted wheat, respectively.

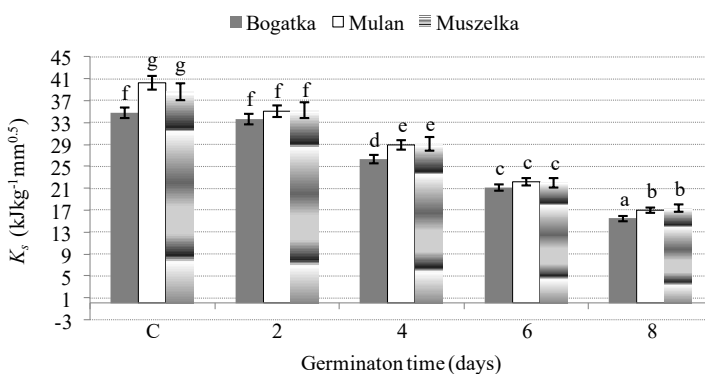

Figure 4. Influence of germination time on Sokołowski's grinding index (the values designated by the different capital are significantly different ($\alpha = 0.05$))

The relation between the K_s of sprouted wheat and time of germination (T_g) for tested cultivars of sprouted wheat can be described as follow:

$$K_s = -2,773 T_g + 38,88; R^2 = 0,965 \quad (5)$$

During germination, the content and bioactivity of compounds with nutraceutical potential change dramatically and may be strongly affected by the germination conditions (Świeca *et al.* 2012). The values of EC_{50} determined both by free radicals scavenging activity and ferric reducing power were significantly lower from the values of EC_{50} obtained for wheat before germination (Table 1). As the time of sprouting increased significantly lower values of EC_{50} were obtained and this indicate that the antioxidant activity of germinated wheat increased too. This tendency was observed for all tested wheat. Also others authors showed that time of germination significantly changed the antioxidant activity of sprouted wheat (Young *et al.*, 2001).

Table 1. Antioxidant activity (EC_{50} , mg dm/mL) of sprouted wheat in relation to germination time

Cultivar	Antioxidant assay	Germination time (days)				
		C*	2	4	6	8
Bogatka	ABTS	53.1 ^{Da} ±2.47	38.8 ^{Ca} ±1.25	34.4 ^{Bc} ±1.18	32.9 ^{Bc} ±1.26	28.7 ^{Ab} ±1.98
Mulan		77.3 ^{Db} ±3.11	42.5 ^{Cb} ±1.18	28.5 ^{Ba} ±1.22	24.1 ^{Aa} ±1.32	22.9 ^{Aa} ±1.65
Muszelka		50.6 ^{Ea} ±2.68	36.9 ^{Da} ±1.36	31.1 ^{Cb} ±1.13	27.4 ^{Bb} ±1.58	23.0 ^{Aa} ±0.85
Bogatka	FRAP	6.8 ^{Db} ±0.17	6.2 ^{Cb} ±0.17	5.6 ^{Bb} ±0.16	5.4 ^{Bb} ±0.15	4.7 ^{Ab} ±0.35
Mulan		6.3 ^{Ea} ±0.14	5.2 ^{Da} ±0.14	4.4 ^{Ca} ±0.28	3.8 ^{Ba} ±0.18	3.2 ^{Aa} ±0.24
Muszelka		7.2 ^{Ec} ±0.51	6.7 ^{Dc} ±0.19	6.5 ^{Cc} ±0.24	6.1 ^{Bc} ±0.25	5.6 ^{Ac} ±0.29

*C - control seed, ABTS – antiradical activity, FRAP - ferric reducing power

**the values designated by the different capital letters in the lines of the table are significantly different ($\alpha=0.05$)

**the values designated by the different small letters in the columns of the table are significantly different ($\alpha=0.05$)

CONCLUSIONS

The present study demonstrated that the time of sprouting of wheat has a significant influence on the grinding process, both on the grinding energy requirements and the distribution of the particle size. All values of grinding indices showed that as the time of sprouting increased germinated wheat was more easily pulverized than sound wheat.

This tendency was observed for each tested cultivar. Moreover, sprouting also caused an increase antioxidant activity of seedlings.

ACKNOWLEDGMENTS

Authors acknowledge the financial support of the Polish National Science Centre (Grant 2012/07/B/NZ9/02463).

REFERENCES

- Chavan, J., Kadam, S.S. (1989): Nutritional improvement of cereals by sprouting, *Crit. Rev. Food. Sci.* 28, 401–437. <http://dx.doi.org/10.1080/10408398909527508>
- Dziki, D., and Laskowski, J. (2010): Study to analyze the influence of sprouting of the wheat grain on the grinding process, *J. Food Eng.* 96, 562–567. <http://dx.doi.org/10.1016/j.jfoodeng.2009.09.002>
- Dziki, D., Gawlik-Dziki, U., Rózyło, R., Miś, A. (2015a): Drying and grinding characteristics of four-day-germinated and crushed wheat: A novel approach for producing sprouted flour, *Cereal Chem.* 92 (3), 312-319. <http://dx.doi.org/10.1094/CCHEM-09-14-0188-R>
- Dziki, D., Gawlik-Dziki, U., Kordowska-Wiater, M., & Domań-Pytka, M. (2015b): Influence of elicitation and germination conditions on biological activity of wheat sprouts, *Journal of Chemistry.* <http://dx.doi.org/10.1155/2015/649709>
- Greffeulle, V., Abecassis, J., Barouh, N., Villeneuve, P., Mabile, F., Bar L'Helgouac'h, C., Lullien-Pellerina, V. (2006): Analysis of the milling reduction of bread wheat farina: physical and biochemical characterization, *J. Cereal Sci.* 45, 97-105. <http://dx.doi.org/10.1016/j.jcs.2006.07.003>
- Hemery, Y., Rouau, X., Lullien-Pellerin, V., Barron, C., Abecassis, J., (2007): Dry processes to develop wheat fractions and products with enhanced nutritional quality, *J. Cereal. Sci.* 46, 327-347. <http://dx.doi.org/10.1016/j.jcs.2007.09.008>
- Hung, P.V., Hatcher, D.W., Barker, W. (2011): Phenolic acid composition of sprouted wheats by ultra-performance liquid chromatography (UPLC) and their antioxidant activities, *Food Chem.* 126, 1896-1901. <http://dx.doi.org/10.1016/j.foodchem.2010.12.015>
- Larsson, M., Sandberg, A.-S. (2006): Phytate reduction in oats during malting, *J. Food Sci.* 57, 994-997. <http://dx.doi.org/10.1111/j.1365-2621.1992.tb14340.x>
- Letang, C., Samson, M.-F., Lasserre, T.-M., Chaurand, M., Abecassis, J., (2001): Production of starch with very low protein content from soft and hard wheat flours by jet milling and air classification, *Cereal Chem.* 79, 535-543. <http://dx.doi.org/10.1094/CCHEM.2002.79.4.535>
- Lorenz, K., Valvano, R. (2006): Functional characteristics of sprout-damaged soft white wheat flours, *J. Food Sci.* 46, 1018-1020. <http://dx.doi.org/10.1111/j.1365-2621.1981.tb02982.x>
- Miś, A., Grundas, S. (2002): Wheat grain hardness modified by the laboratory sprouting test, *International Agrophysics* 16, 283-288.
- Neethirajan, S., Jayas, D.S., White, N.D.G., (2007): Detection of sprouted wheat kernels using soft X-ray image analysis, *J. Food Eng.* 81, 509-513. <http://dx.doi.org/10.1016/j.jfoodeng.2006.11.020>

- Oyaizu, M. (1986): Studies on products of browning reactions: antioxidative activities of products of browning reaction prepared from glucosamine, *Japanese Journal of Nutrition and Dietetics*, 44, 307-315. <http://dx.doi.org/10.5264/eiyogakuzashi.44.307>.
- Shingare, S.P., Thorat, B.N. (2014): Fluidized bed drying of sprouted wheat (*Triticum aestivum*), *Int. J. Food Eng.* 10, 29-37. <http://dx.doi.org/10.1515/ijfe-2012-0097>
- Sokołowski, M., (1996): Energy consumed in grinding – a new idea of a general law of comminution – new tests stands and testing results. *Récents Progress en Génie Procédés* 10, 221-226.
- Świeca, M., Gawlik-Dziki, U., Kowalczyk, D., Złotek, U. (2012): Impact of germination time and type of illumination on the antioxidant compounds and antioxidant capacity of *Lens culinaris* sprouts, *Sci Hortic-Amsterdam* 140, 87-95. <http://dx.doi.org/10.1016/j.scienta.2012.04.005>
- Velu, V., Nagender, A., Prabhakara Rao, P.G., Rao, D.G. (2006): Dry milling characteristic of microwave dried maize grains, *J. Food Eng.* 74, 30-36. <http://dx.doi.org/10.1016/j.jfoodeng.2005.02.014>
- Xu, S., Hu, B., He, Z., Ma, F., Feng, J., Shen, W., Yan, J. (2011): Enhancement of salinity tolerance during rice seed germination by presoaking with hemoglobin, *Int. J. Mol. Sci.* 12, 2488-2501. <http://dx.doi.org/10.3390/ijms12042488>
- Yang, F., Basu, T.K., Oraikul, B. 2001: Studies on germination conditions and antioxidant contents of wheat grain, *Int. J. Food Sci. Nutr.* 52, 319-330, 2001. <http://dx.doi.org/10.1080/09637480120057567>

SURVEY OF β -GLUCANS IN DOMESTIC BARLEY'S VARIETIES

UDC 663.439(497.5)

Alojzije Lalić¹, Gordana Šimić¹, Vinko Krstanović², Kristina Mastanjević^{2}*

¹*Institute of Agriculture Osijek, Južno predgrađe 17, HR-31 000 Osijek, Croatia*

²*Josip Juraj Strossmayer University of Osijek, Faculty of Food Technology Osijek, Franje Kuhača 20, HR-31000 Osijek, Croatia*

*Corresponding author: kristina.mastanjevic@ptfos.hr

ABSTRACT

β -glucans in cereals are desirable, but malting and brewing industries appreciate lower levels of these compounds because high level of β -glucans in barley varieties can cause unsatisfactory degradation of cell walls during malting. Low to moderate β -glucan content in barley is preferable for malt production. The aim of this study was to investigate the share of β -glucans in 16 Croatian barley varieties at three representative locations in eastern Croatia: Osijek, Slavonski Brod and Tovarnik over three consecutive seasons (2012-2014). Total β -glucan content in barley samples was determined using enzymatic method. Overall, total β -glucan contents ranged between 2.21 and 4.50 g/100 g dry weight, where barley feed variety had the highest and malting barley variety had the lowest content. Most of the investigated barley varieties had total β -glucan content lower or significantly lower than 4 %. Barley varieties used for livestock (feed and hulless varieties) appear to have the highest (feed > 4.4, hulless 4.6 > g/100 g), and brewing varieties have the lowest β -glucan (< 3.6 g/100 g).

Keywords: β -glucans; barley, brewing quality

INTRODUCTION

β -glucans appear to beneficial effects on human health and that is why many research have been opened regarding this subject. However, from brewers' perspective, β -glucans are not an appealing component in cereals intended for malting and brewing.

β -glucans are non-starch polysaccharides characterized by (1 \rightarrow 3), (1 \rightarrow 4) β -D-glucose linkage (Vis and Lorenz, 1997) and are main constituents of endosperm cell walls. They can be found in barley and oats, while in other cereals (wheat) they are present to a significantly lesser extent (Vis and Lorenz, 1997). Total content of β -glucans in barley normally ranges from 2 to 8 % (Marconi *et al.*, 2014) and depends on genetic factors, but climatic conditions, agrotechnical measures and soil type also contribute to the total β -glucan content in barley (Zheng *et al.*, 2000; Aastrup, 1979; Narziss *et al.*, 1999). β -glucans, in small amounts, contribute to beer foam stability and improve beer organoleptic properties (i.e. beer mouth feel) (Havlová *et al.*, 2006). However, in higher levels they cause serious problems during both, malting and brewing. During malting,

high total β -glucan content can lead to unsatisfactory degradation of cell walls, which disrupts the germination and reduces the malt extract (Wang *et al.*, 2004). β -glucans residues in malt can lead to poor mash conversion, resulting in highly viscous wort. This can cause problems during the filtration process (Vis and Lorenz, 1998; Wang *et al.*, 2004) and induce haze in beer (Jin, 2002).

This is why barley with low to moderate β -glucan content is preferable for malt production (Vis and Lorenz, 1998). It is interesting that the existing research results suggest the use of six-rowed barley that has somewhat lower β -glucan content than the two-rowed varieties (Lehtonen and Aikasalo, 1987; Zhang *et al.*, 2001). Based on the intended end use in respect to the characteristics of barley varieties, they can be classified as malting, feed and malting-feed. Multipurpose varieties are interesting to the producers because most of the varieties are winter varieties with somewhat higher yields (30% higher) and lower cost compared to spring varieties. However, in order to be acceptable for malting/brewing, main quality parameters have to be suitable, such as β -glucan content, protein share, friability, glassy grains share.

The objective of this study was to determine the total β -glucan content in 16 barley varieties collected at three locations over three consecutive seasons (2012-2014). The acquired data will then serve maltsters as an important input information upon the admission of barley for malting.

MATERIALS AND METHODS

Samples. Samples of 16 different barley varieties (Rex (P/S), Barun (P/S), Bingo (S), Bravo (S), Maxim (P/S), Premium (P/S), Gazda (P/S), Lukas (P/S), Maestro (P/S), Merkur (P/S), Trenk (P/S), Lord (P/S), Tiffany (P), Vanessa (P), Matko (GZ), GZ-184 (GZ)) were collected over three consecutive seasons (2012–2014) from variety trials (Agricultural Institute, Osijek) at three representative locations in eastern Croatia: Osijek (OS), Slavonski Brod (SB), and Tovarnik (TO). Labels P/S for brewing and feed varieties, S for feed varieties and B for brewing varieties describe the purpose for which a certain variety can be classified. Sampling (5 kg per sample) was performed on cleaned and processed barley grains (according to EBC 3.1. method) and the samples were kept refrigerated in sterile dry containers. Soil types at locations were: eutric cambisol (OS), alluvial soil (OS) and hipogley soil (TO). All varieties are winter two-rowed varieties that originate from Agricultural Institute Osijek, except for varieties Tiffany and Vanessa that originate from Germany and variety Lord that is six-rowed.

Determination of total β -glucan content. Prior to β -glucan determination the samples were milled using standard laboratory knife mill with 1 mm sieve (MF10.2 basic, IKA Labortechnik, Germany) and after that using kitchen coffee grinder (Braun KMM 10). Barley flour samples were kept in sealed plastic bags until β -glucan content determination. Total β -glucan content in barley was determined according to enzymatic method (AOAC Method 995.16) using a commercial assay kit (Mixed Linkage determination kit, Megazyme International Ireland, Bray, Ireland).

Statistical analysis. Statistical analysis was carried out using Statistica Ver. 8.0 StatSoft Inc. Tulsa, OK, USA. The impact of individual factors (variety, location, intended use) on differences in average values of β -glucan were analysed using the analysis of variance (ANOVA) and the Fisher's least significant difference test (LSD), with statistical significance being set at $P < 0.05$.

RESULTS AND DISCUSSION

Croatian varieties of different traits and grain properties were investigated in this research. Most biotic and abiotic stress in Croatian varieties is caused by diseases, acidic soil, cold weather, draught, frequent extreme temperatures, and rainfall during germination and growth period. High temperatures during May and June are also known to affect the intensity and grain filling period and can cause forced maturation of the grain (Lalić *et al.*, 2006; Lalić *et al.*, 2007), the most unfavourable abiotic stress. Forced maturation can lead to the increase in total β -glucan content of barley (Passarella *et al.*, 2002). Both genotype and environmental conditions have an impact on the content of β -glucans, although genetic factors seem to be of more importance (Molina-Cano *et al.*, 1997).

Malting procedure is time limited, meaning that β -glucan degradation takes place at germination temperatures, the only period in which enzymes degrade β -glucans. Solubility of β -glucans is greatly affected by the structure and interrelations of certain β -glucan fractions. Starting concentration of β -glucan content in grains correlates with β -glucan concentration in wort, but applied brewing technological procedure contributes to final β -glucan content in wort. Even though there are no recommendations for brewers regarding the total β -glucan content in malt, when it comes to wort it is recommended it should not exceed 200 mg/L (Bamfort, 2006).

American malting Barley Association has more stringent recommendations. Program for barley development sets recommended β -glucan concentrations in wort at < 100 mg/L for two-row barley and < 120 mg/L for six-row barley (AMBA, 2014). However, in practice greater values are tolerated (Malt specifications & brewing performance: IGB (Institute & Guild of Brewing (methods) < 200 mg/L, or EBC (European Brewery Convention) < 250 mg/L). Nevertheless, it is often hard to achieve the recommended values because the total β -glucan content of the starting raw material (barley) is about 4 % (EBC, 1998; MEBAK, 1997). For three consecutive years (2012-2014) total β -glucan content was analyzed in chosen barley varieties, and the results are given in Fig. 1. The results show that total β -glucan content of the majority of varieties was lower or significantly lower than 4 %. Five varieties, namely Bingo, Bravo, Rex, Lord and Lukas had total β -glucan content higher than 4 %. This can be explained by the fact that latter are early-maturing varieties and thus avoid the forced maturation caused by draught period.

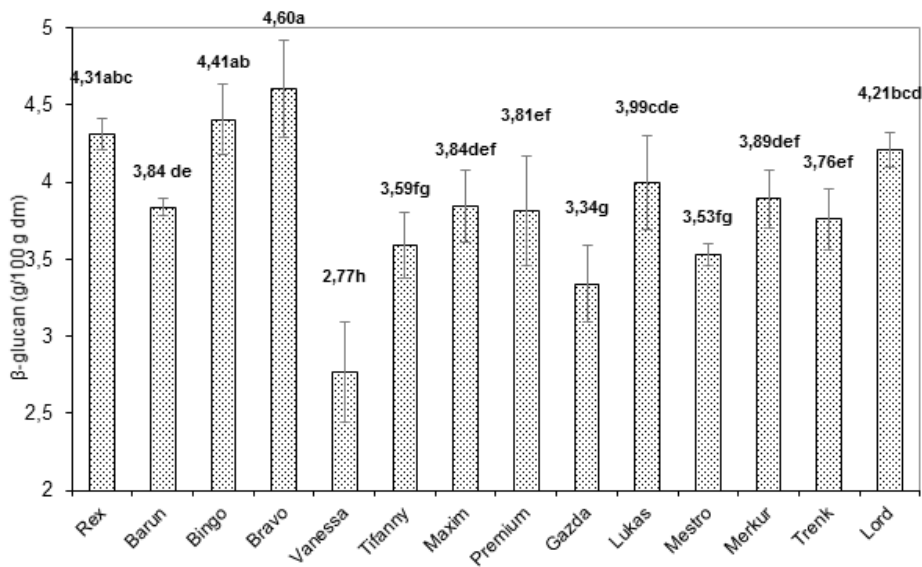

Figure 1. Three-year (2012-2014) average total β -glucan content in analysed barley varieties.

Climatic conditions typical for Croatia and South-eastern Europe are shown in **Tab. 1**. Genotypes with later heading date and longer vegetation period (Tiffany, Lord and Vanessa) mostly have lower yields in regard to earlier heading date varieties (Bingo, Barun and Maxim) (Lalić *et al.*, 2003; Lalić *et al.*, 2006). Lowest total β -glucan content (<3 %) was determined for variety Vanessa at all three investigated locations. This was expected, since this German variety is classified as strictly malting variety. Variety Tiffany, also a German malting variety, had significantly higher total β -glucan content than Vanessa, but still less than 4 %. Even though not classified as strictly malting varieties but as a combined malting-feed varieties, Gazda and Maestro also had higher total β -glucan in regards to malting varieties. Maestro gave narrow and Gazda wider dispersion of the total β -glucan content over the entire investigated period. A clear differentiation of varieties on the basis of their intended purpose (i.e. malting, feed and malting-feed) was noticed considering the β -glucan share. This was expected since the earlier investigation of the same varieties showed significant differences between other quality parameters (total and soluble nitrogen, albumin and globulin fractions of proteins, extract, 1000 kernels weight etc.) (Kovačević *et al.*, 2008). When varieties were grouped according to their end use (Fig. 2), a distinct and clear genotype influence can be noticed regarding the total β -glucan content. Varieties inside one group differ statistically, which reflects to differences between groups.

Table 1. Climatic data on mean monthly air temperatures and rainfall for investigated period 2011/12 – 2013/14 for Osijek, Slavonski Brod and Tovarnik locations

location	OSIJEK (TO)								
	temperature of air (°C)				rainfall (mm)				
year	2011	2012	2013	2014	2011	2012	2013	2014	
mean	11.7	12.3	12.1	12.8	-	-	-	-	
total	-	-	-	-	422.2	599.2	767.2	809.4	
vegetation period X - VI	8.3		9.1	10.2		392.3		679.0	573.2
location	SL. BROD (SB)								
	temperature of air (°C)				rainfall (mm)				
year	2011	2012	2013	2014	2011	2012	2013	2014	
mean	11.6	12.4	11.9	12.6	-	-	-	-	
total	-	-	-	-	432.9	640	738.8	962.9	
vegetation period X - VI	8.3		9.1	9.9		419.5		647.2	567.9
location	TOVARNIK (TO)								
	temperature of air (°C)				rainfall (mm)				
year	2011	2012	2013	2014	2011	2012	2013	2014	
mean	12.1	12.9	12.6	13.4	-	-	-	-	
total	-	-	-	-	397.4	448.4	733.4	824.0	
vegetation period X - VI	8.9		9.6	10.8		332.4		625.3	460.9

(source: Državni hidrometeorološki zavod Hrvatske / Meteorological and Hydrological Service of State)

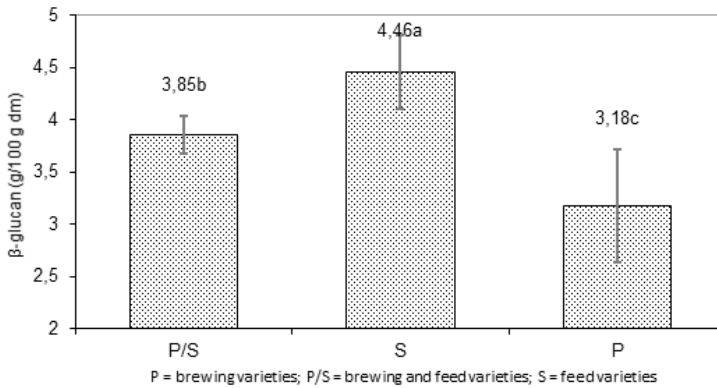

Figure 2. Three-year (2012-2014) average total β -glucan content in analysed barley varieties in respect to intended use classification.

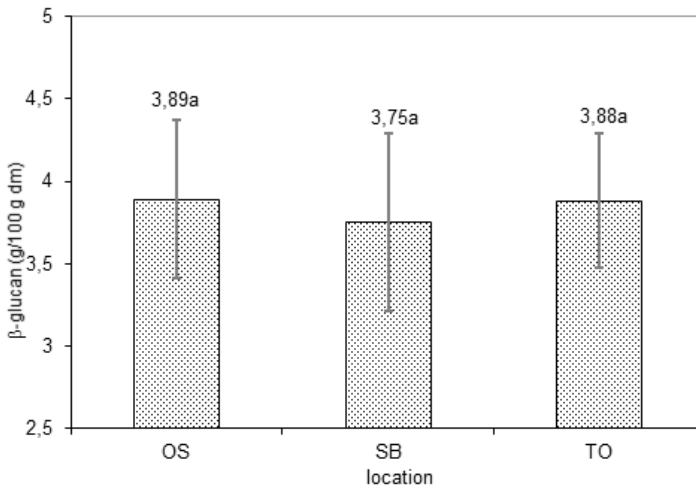

Figure 3. Three-year (2012-2014) average total β -glucan content in analysed barley varieties. in respect to growth location.

Out of many environmental factors, this investigation followed only the influence of location on total β -glucan share. No statistically significant influence of location on the total β -glucan share has been determined during this three-year experiment (Fig. 3).

However, the differences between the varieties at each location were noticed depending on the year, confirming the impact of genotype on the total β -glucan share. All the above listed varieties were grown at trial fields, subjected to identical agro-technical measures and weather conditions. Varieties grouping around the three-year average of total β -glucan content at all three locations is given in **Fig.3**. A clear distinction between varieties (based on their end use) can be seen. Variety Gazda, as previously stated, has singled out from the combined malting-feed group and joined the malting group with Vanessa and Tiffany. Feed group varieties have also singled out, while the majority of varieties in the malting-feed group clustered around the mean value. Apart from Vanessa and Tiffany, specifically designed German malting varieties, the results showed that a large number of the investigated Croatian malting-feed varieties can also be acceptable for brewing in respect to their total β -glucan content. Two investigated varieties of hulles barley were excluded from data processing. Namely, even though they gave acceptable results for β -glucan content in starting barley, β -glucan content is usually unacceptably high in wort. β -glucan content in Matko was 4.62 g/100g dm and in GZ-184 4.05 g/100g dm. Variety GZ-184 is borderline acceptable according to β -glucan content in grains, but after malting β -glucan content amounted to high 320 mg/L while the amount of β -glucan in Matko was totally unacceptable with 500 mg/L.

CONCLUSIONS

Results of this study indicate that barley varieties classified as feed varieties (used as livestock feed) contain highest total β -glucan content (> 4.4 g β -glucan /100 g dry weight), and malting varieties had the lowest total β -glucan content (< 3.6 g β -glucan /100 g dry weight). Total β -glucan content of seven out of ten varieties classified as malting-feed varieties ranged from 3.75 – 4.25 g β -glucan /100 g dry weight. Gazda and Maestro, two malting-feed varieties had total β -glucan content significantly lower than 4 %, which makes them suitable for malting. Significant differentiation of varieties was determined based on their total β -glucan content, while location had no statistically significant impact.

REFERENCES

- Aastrup S. (1979): The effect of rain on β -glucan content in barley grains, *Carlsberg Res. Commun.* Vol. 44, p. 381-393.
- AMBA <http://www.mbaa.com/districts/NorthernCalifornia/Documents/2014%20Joint%20Technical%20Conference/2-1%20M%20Davis%20Future%20of%20Malting%20Barley%20in%20N%20America.pdf> (september, 2014)
- AOAC International 1995. Official Methods of Analysis of AOAC International, 16th ed. Methods 992.28 and 995.16. The Association, Arlington, VA.
- Bamforth C.W. (2006): *Brewing new technologies*. Woodhead Publishing Limited, Cambridge, England, 13, 88.
- European Brewery Convention (EBC), *Analytica* 5. ed. 1998. (methods 3.3.1. and 4.16.1), Fachverlag Hans Carl, D-Nürnberg

- Havlová, P., Lancova, K., Váňová, M., Havle, J., Hajšlová, J. (2006): The effect of fungicidal treatment on selected quality parameters of barley and malt, *J. Agric. Food. Chem.* 54, 1353-1360.
- Jin, Y. (2002): Effect of β -glucan and environmental factors on the physical and chemical properties of wort and beer, PhD thesis, Dalhousie University, Halifax, Nova Scotia.
- Kovačević J., Lalić A., Jurković Z. (2008): Characterization of winter barley genotypes in Croatian environment, *Cereal Res. Commun.* 36, S5; Part 3:1583-1586.
- Lalić A., Kovačević J., Novoselović D., Drezner G., Babić D. (2003): Comparison of pedigree and single seed descent method (ssd) in early generation of barley, *Poljoprivreda* 9, 33-37.
- Lalić A., Kovačević J., Drezner G., Novoselović D., Babić D., Dvojković K., Šimić G. (2006): response of winter barley genotypes to croatian environments-yield, quality and nutritional value, *Cereal Res. Commun.* 34 (1), 433-436.
- Lalić A., Kovačević J., Šimić G., Drezner G., Guberac V. (2007): Environmental effects on grain yield and malting quality parameters of winter barley, *Cereal Res. Commun.* 35 (2), 709-712.
- Lehtonen M., Aikasalo R. (1987): Note: Beta-Glucan in Two- and Six-Rowed Barley, *Cereal Chem.* 64, 191-193.
- Malt specifications & brewing performance. (2002) *The Brewer International*. www.igb.org.uk, Vol. 2 (10) pp. 27-30
- Marconi, O., Tomasi, I., Dionisio, L., Perretti, G., Fantozzi, P. (2014): Effects of malting on molecular weight distribution and content of water-extractable β -glucans in barley, *Food Res. Int.* 64, 677-682.
- Middle European Brewing Analysis Commission, Brautechnische Analysenmethoden 3. ed. Band I (1997) (MEBAK), Methods 2.5.7., Selbstverlag der MEBAK, Freising-Weihenstephan
- Molina-Cano, J.L., Francesch, M., Perez-Vendrell, A.M., Ramo, T., Voltts, J. and Brufau, J. (1997) Genetic and environmental variation in malting and feed quality of barley, *J. Cereal Sci.* 25, 37-47
- Narziß L. (1999): Die Technologie der Malzbereitung, 7 ed., F. Enke, Stuttgart, pp.25-30, 422-429.
- Passarella V., Savin R., Slafer G. (2002): Grain weight and malting quality in barley as affected by brief periods of increased spike temperature under field conditions, *Aust. J. Agric. Res.* 53, 1219-1227.
- Vis, R.B., Lorenz, K. (1998): Malting and brewing with a high β -glucan barley, *Lebensmittel Wissenschaft und Technologie*, 31, 20-26.
- Vis, R.B., Lorenz, K. (1997): β -glucans: importance in brewing and methods of analysis, *Lebensmittel Wissenschaft und Technologie* 30, 331-336.
- Wang, J., Zhang, G., Chen, J., Wu, F. (2004): The changes of β -glucan content and β -glucanase activity in barley before and after malting and their relationship to malt qualities, *Food Chem.* 86, 223-228.
- Zheng, G. H., Rossnagel, B. G., Tyler, T. R. T., Bhatta, R. S. (2000): Distribution of β -glucan in the grain of hulless barley. *Cereal Chem.* 77(2), 140-144.

IMMATURE HULL-LESS BARLEY GRAIN APPLICATION IN FUNCTIONAL DAIRY PRODUCT

UDC 664.696 : 637.13

Jelena Zagorska^{1*}, Daina Karklina¹, Ingmars Cinkmanis², Agnese Vecstaudza¹,
Liga Skudra¹

¹Department of Food Technology, Latvia University of Agriculture, Faculty of Food Technology,
LV-3001, Jelgava, Latvia

*Corresponding author: jelena.zagorska@llu.lv

²Department of Chemistry, Latvia University of Agriculture, Faculty of Food Technology,
LV-3001, Jelgava, Latvia

ABSTRACT

Present research has been supported by the National research programme "AgroBioRes" (2014–2017), project No. 4 "Sustainable use of local agricultural resources for qualitative and healthy food product development" (FOOD). The purpose of the research was to investigate immature hull-less barley use in yoghurt production. For the experiments immature and mature hull-less barley 'Irbe', pasteurized skimmed milk, and starter culture Yo-Flex Harmony was used. The following quality parameters were established using standard methods: content of vitamins B₁, B₂, E, and individual sugars; yoghurt samples were also analysed for lactic acid bacteria count, pH, titratable acidity, and viscosity. Relatively high vitamin and individual sugar content was established in immature cereals comparing with mature ones. Furthermore, the positive effect of the added immature cereals on lactic acid bacteria development in yoghurt was found – higher bacteria count was in samples with grain additive, obtained results were confirmed with pH and titratable acidity. Significant influence of analysed cereals on yoghurt viscosity was established. As a result, immature grain additive has prebiotic effect on lactic acid bacteria growth and allows production of yoghurt with functional properties.

Keywords: immature cereals, yoghurt, lactic acid bacteria

INTRODUCTION

Fermented milk products are widely distributed and used worldwide (Li *et al.* 2012). These are modified foods generated by the action of microbes or their enzymes to attain desirable biochemical changes. Yogurt is one of the popular fermented milk products known for thousands of years and is considered to have more nutritional benefits than milk. For yoghurt production milk is pasteurized followed by the inoculation of starter cultures (*Lb. Bulgaricus* and *Str. thermophilus* act symbiotically during fermentation) under standard batch fermentation. These cultures ferment lactose in milk to lactic acid, causing milk to curdle and form yogurt. It may be supplemented with fruits and other additives to enhance the flavour and taste, as well health benefits. The health promoting attributes of

yogurt containing live and active cultures are well documented (Adolfsson *et al.* 2004; Patel and Walker 2004; El-Abbadi *et al.* 2014). Dairy products provide a strong foundation for health-promoting innovative ingredients toward the development of functional foods and dietary supplements (Michaelidou and Steijns 2006; Steijns 2008). Additionally, fermented foods supplemented with probiotics are rich in essential nutrients like vitamins B₁₂, B₆, K₂, biotin, protein, essential amino acids, and fatty acids that fulfil the body needs (Ashraf and Shah, 2011). Many of the probiotics produce wide variety of antimicrobial substances, for instance, lactic acid, ace-tic acid, formic acid, propionic acid, ethanol, diacetyl, acetaldehyde, reutericycline, reuterin, fatty acids, and bacteriocins that are inhibitory to pathogens (Jain *et al.* 2009). Functional dairy foods are therefore, recommended as an alternative to boost immune system, especially among children and elders (Parvez *et al.* 2006; Toma and Pokrotnieks 2006). Further, the consumption of functional dairy products with certain *Lactobacillus* bacteria helps to lower the cholesterol in blood (Parvez *et al.* 2006).

In the last few years the need to produce food with added value has forced to search for new ingredients and health-promoting compounds. Prebiotics are non-digestible food ingredients that beneficially affect the host by selectively stimulating the growth and/or activity of one or a limited number of bacteria in colon that can improve the host health (Gibson and Roberfroid 1995). By using prebiotics, the selective growth of certain indigenous gut bacteria can be improved; thereby any viability problems of orally administered bacteria in upper gastrointestinal tract can be solved.

The commonly used prebiotics in dairy foods are fructooligosaccharides, xylooligosaccharides, and lactose derivatives such as lactulose, lactitol, galactooligosaccharides, and soya bean oligosaccharides (Wilder-Smith *et al.* 2013, Beitane, 2008).

According to the literature grains can be a good source of fiber, vitamins and microelements, as well as exopolysaccharide (Kunkulberga, 2010), as result a good source of prebiotic for functional food production.

Hull-less barley (HB) has been investigated in many countries for use in feed, food, and industry since the publication of the last review in 1986. Hull-less barley has been used in many food industries: bakery, beverage production and others, but demand for the new product development leads to develop new functional products (Abdel-Haleem and Awad, 2015). In many countries wheat is used for food production (bread, drought and others) (Abdel-Haleem and Awad, 2015), better functional properties comparing matured and immatured grains were obtained with the last one (Pepe *et al.*, 2013), still it is a good source of exopolysaccharide, but there is the lack of information about hull-less barley application in dairy industry, therefore the purpose of the research was to investigate immature hull-less barley use in yoghurt production.

MATERIALS AND METHODS

Raw Materials

Immature and mature hull-less barley 'Irbe' year 2014 used in this study were obtained from State Priekuli Plant Breeding Institute, Latvia.

Skimmed milk and starter culture Yo-Flex Harmony, containing *Streptococcus thermophilus*, *Lactobacillus fermentum*, *Lactobacillus delbrueckii subsp. bulgaricus* (Chr.Hansen, Denmark), were used for experiments. Yoghurt culture was stored in freezer at -18 °C and used directly for milk fermentation.

Yoghurt preparation technology

The yoghurt was made according following scheme: skimmed milk pasteurization (95 °C, 2-5 min), milk cooling till 43 °C, immature hull-less barley addition to 100 g of milk (1 %, 1.5 %, 2.0 %, 3.0 %), starter culture inoculation with 2 ml of milk suspension (10⁶ cfu ml⁻¹), mixing, fermentation at °C, 4-6 h, yoghurt mixing and cooling till 10 °C, maturation for 24 h at 4-6 °C, storage 4-6 °C.

Determination of vitamin content in grains

Determination of the vitamin content was done according to following standard: B₁ - AOAC 986.27, B₂ - AOAC 970.65, E - AOAC 971.3.

Determination of Individual Sugars' Content

Before the analysis 5 g of milled grain samples were extracted with 20 mL deionized water and stirred for one hour. The obtained extract was filtered through a high-performance liquid chromatography (HPLC) syringe filter with pore size of 0.45 µm. The content of individual sugars (fructose, glucose, sucrose, and maltose), was determined by high-performance liquid chromatography (Shimadzu LC 20 Prominence, Japan). Chromatographic parameters were set as follows: detector – refractive index RID-10A; column – Alltech NH₂, 4.6 mm x 250.0 mm, 5µm; temperature 25 °C; isocratic elution regime, mobile phase –A – acetonitrile, B – deionized water (A70:B30); capacity of the injection sample – 10 µL; total time of the analysis – up to 15 min; flow rate – 1.0 mL/min. Acquired data were processed using Shimadzu LabSolutions software (LCsolution Version 1.21 SP1).

Detection of Lactic acid bacteria count

Detection of Lactic acid bacteria count was done according LVS ISO 15214:1998 by using MRS agar media (Scharlau, Spain). Media was prepared according to LVS CEN 44ISO/TS 11133-1:2009. Sample dilutions were performed according to LVS EN ISO 8261:2002 and ISO 6887-5:2010.

Colony forming units of the lactic acid bacteria were determined by means of ISO 15214:1998. The chosen parameters for cultivation of lactic acid bacteria in MRS agar were 72 hours at 37 °C.

Detection of titratable acidity of yoghurt

Titratable acidity of yoghurt samples was determined by titration following the LVS ISO 6092:2003 using phenolphthalein as an indicator.

Detection of yoghurt pH

Determination of the pH was performed according to LVS ISO 5546:2010 „Caseins and caseinates –determination of the pH”, by using pH-meter, 3520 pH Meter-JENWAY (Barloworld Scientific Ltd., Essex, UK).

Detection of the rheological properties of yoghurt

The rheological properties of yoghurt were determined with the DV-III Ultra Rheometer BROOKFIELD rheometer equipped with thermostatically controlled water bath TC-102 at 20.0±0.3 °C. All measurements were carried out by BROOKFIELD standard methods in three independent repeats on 1st day with controlled shear rate using a spindle SC4-16. The apparent viscosity was calculated at shear rate 7 s⁻¹. The flow curves were described by Herschel-Bulkley model.

Statistical Analysis

The results (mean, standard deviation) were processed by mathematical and statistical methods. Data were subjected to one-way analysis of variance (ANOVA) by Microsoft Office Excel 2007; significance was defined at $p < 0.05$.

RESULTS AND DISCUSSION

For choosing better additive in yoghurt production during research two types of grains were compared: mature and immature hull-less barley. The concentration of B group and E vitamins was evaluated in both samples (see Table 1).

Table 1. Concentration of vitamins B₁, B₂, E in hull-less barley

Hull-less barley	Concentration of vitamin		
	B ₁ , mg 100g ⁻¹	B ₂ , mg 100g ⁻¹	E, mg 100g ⁻¹
Immature	0.18±0.01	0.22±0.01	3.07±0.1
Mature	0.32±0.01	0.11±0.01	2.86±0.1

Comparing B groups vitamins' content significantly higher ($p < 0.05$) 1.78 times, concentration of vitamin B₁ was in mature grains - 0.32 mg 100 g⁻¹, than in immature grains

(0.18 mg 100g⁻¹). Opposite results were obtained with B₂ vitamin content, the highest concentration ($p < 0.05$) was established in immature grains, accordingly 2 times. Significant difference was not established ($p > 0.05$) compared E vitamin concentration in grains, 1.07 times higher concentration was in immature grains.

Sugar concentration and in hull-less barley is given in Table 2.

Table 2. Concentration of sugars in hull-less barley

Hull-less barley	Fructose, %	Glucose, %	Sucrose, %	Maltose, %
Immature	0.20	0.29	0.14	0.03
Mature	0.35	0.30	0.36	1.06

Comparing sugar concentration better results were obtained in case with immature grains. The significant higher concentration ($p < 0.05$) of the following sugars were detected in immature grains: fructose - 1.75 times, sucrose - 2.57 times, maltose 35.3 times. Therefore for the following experiment immature hull-less barley was chosen as yoghurt additive.

Still other authors discuss about producing functional fermented milk products from pastes of some cereals (Desouky *et al.*, 2015) second step of our experiment was to detect, how immature hull-less barley effect yoghurt production and quality. Therefore acidity and pH was controlled during fermentation of milk and in yoghurt (see Figure 1 and Figure 2).

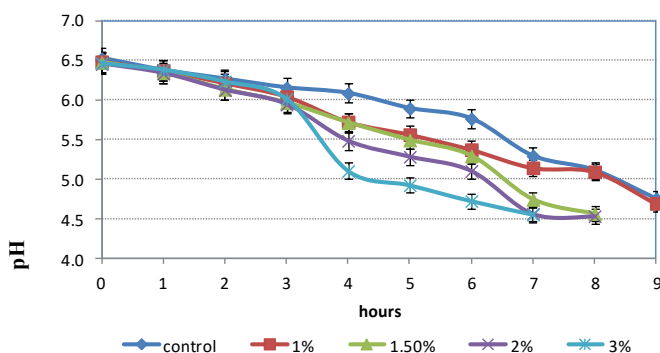

Figure 1. The changes of pH during fermentation of milk samples with immature hull-less barley

During fermentation pH decrease in all analysed samples, after 3rd hour pH of the control sample was significantly higher ($p < 0.05$), comparing with samples containing 3 % of additive, after 6 hours difference was established in all samples comparing with sample

without grain additive. In samples with 1.5 %, 2.0 % and 3.0 % of immature hull-less barley fermentation process was stopped after 8 hours, but control sample, as well as sample with lowest grains additive was fermented for 9 hours.

Similar tendency was with titratable acidity, the lowest acidity in the shortest fermentation time period (8 h) was established in a sample with the highest immature hull-less barley concentration (3 %).

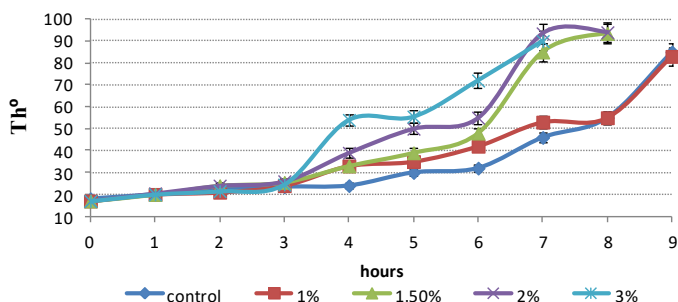

Figure 2. The changes of acidity during fermentation of milk samples with immature hull-less barley

The most important step of our research was to establish, how barley additive will influence lactic acid bacteria development in the yoghurt. Lactic acid bacteria count in different yoghurt samples is given in Figure 3.

The significantly higher lactic acid bacteria count ($p < 0.05$) was established in yoghurt samples with highest immature hull-less grain additive 1.5 %, 2.0 % and 3.0 %.

The obtained results show evidence that the presence of hull-less barley ensures the gradual pH decrease, consequently throughout the fermentation period the increase of Lactic acid bacteria is in samples with 1.5 %, 2.0 % and 3.0 % of grains. At the end of fermentation the highest lactic acid bacteria count was established in milk sample with 3.0 % of barley ($7.14 \cdot 10^9$ cfu·ml⁻¹). An analogy can be found with Beitane (2008) studies, where authors reported that fructo-oligosaccharides are the most effective prebiotics among the investigated sources of carbohydrates, and it is stressed there that the effectiveness of fructo-oligosaccharides increases by increasing their concentration. Other authors conclude that the highest effect of fructo-oligosaccharides can be reached in the lowest concentration – 1 %. (Palframan *et al.* 2002), such result relate with our result, still significant difference were established also with 1% of additives $2.23 \cdot 10^9$ cfu·ml⁻¹, comparing to $1.23 \cdot 10^9$ cfu·ml⁻¹ in control sample.

The obtained results have shown that the added concentration of immature hull-less barley influences significantly the lactic acid bacteria count in samples, therefore it can be concluded that it is possible to facilitate microorganisms growth by adding such kind of prebiotic. The most optimal concentrations are 2 % and 3 % of grains.

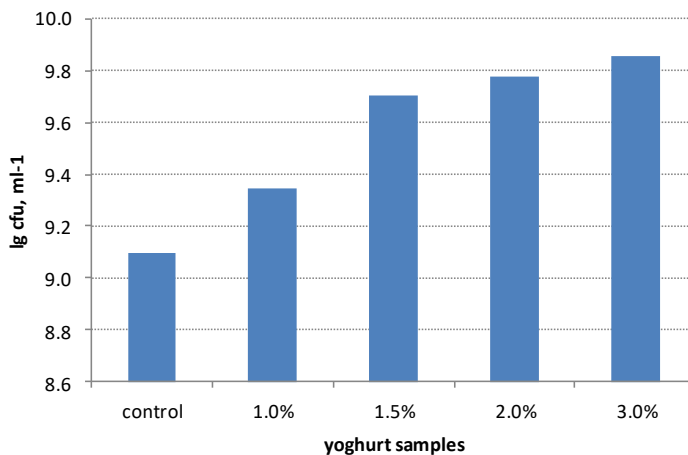

Figure 3. The count of Lactic acid bacteria in yoghurt depending on the concentration of immature hull-less barley

Yoghurt is rheologically unstable fluid, structural properties affect composition and quality of milk, way and methods of dry matter enrichment, production technology, and storage conditions (Domaga and Juszcak, 2004; Kip *et al* 2006). It is important to provide nutritional benefits, as well as stability of fermented dairy products, therefore viscosity of the yoghurt enriched with hull-less barley additive was controlled during the experiment (see Figure 4).

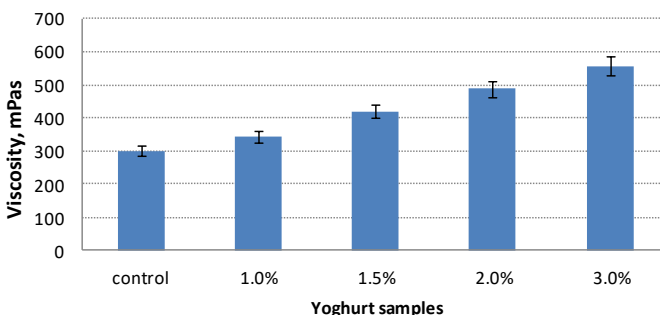

Figure 4. The viscosity in yoghurt depending on the concentration of immature hull-less barley

Research results have shown that the apparent viscosity is significantly higher in fermented milk samples with hull-less barley grain additive than in control sample, but lower comparing with data mentioned in literature (Domaga *et al.*, 2004). Addition of immature hull-less barley grains to yoghurt increases viscosity of the product ($p < 0.05$) from 300 in a control sample to 557 mPa in sample with 3 % of additive. The apparent viscosity is relevant to content of solids in yoghurt (Penna *et al.*, 2006), still hull-less barley addition increases it, therefore such kind of results were expected and are evaluated positive.

Totally, after evaluation research results can be concluded that immature hull-less barley grain can be a good source of prebiotics for functional dairy food production.

CONCLUSIONS

Immature hull-less barley grains contain significant higher ($p < 0.05$) B₂ and E vitamin concentration, fructose - 1.75 times, sucrose - 2.57 times, maltose 35.3 times, comparing with mature grains.

Addition of immature hull-less barley grains to yoghurt significantly increase concentration of lactic acid bacteria in the product from $1.23 \cdot 10^9$ cfu·ml⁻¹ in the control to $7.14 \cdot 10^9$ cfu·ml⁻¹ in sample with 3 % grains additive.

Addition of immature hull-less barley grains to yoghurt significantly increase viscosity of the product ($p < 0.05$) from 300 in control to 557 mPa in sample with 3 % of grain additive.

Optimal proportion of hull-less barley grains is 3 % of yoghurt mass.

Immature hull-less barley grains application for production functional product with new sensory properties has a good perspective.

ACKNOWLEDGEMENT

Present research has been supported by the National research programme "AgroBioRes" (2014–2017), project No. 4 "Sustainable use of local agricultural resources for qualitative and healthy food product development" (FOOD).

REFERENCES

- Abdel-Haleem, A. M, Awad, R. A. (2015): Some quality attributes of low fat ice cream substituted with hullless barley flour and barley β -glucan. *Journal of Food Science and technology*, 52 (10), pp. 6425-6434.
- Adolfsson, O., Meydani, S.N., Russell, R.M. (2004): Yogurt and gut function. *American Journal of Clinical Nutrition*, 80(2), pp. 245–256.
- Ashraf, R., Shah, N.P. (2011): Selective and differential enumerations of *Lactobacillus delbrueckii* subsp. *bulgaricus*, *Streptococcus thermophilus*, *Lactobacillus casei* and *Bifidobacterium* spp. in yoghurt – A review. *International Journal of Food Microbiology*, 149, pp. 194-208.
- Beitane, I., Ciprovica, I. (2008): Prebiotics – the influence factors on growth and survival of probiotics in milk, *Proceedings of the Latvia University of Agriculture*, 2008, 21 (316), pp. 42-50.

- Domaga, J., Juszczak, L. (2004): Flow behaviour of goat's milk yoghurts and bioyoghurts. *Food Science and Technology*, 7 (2).
- El-Abbadi, N.H., Dao, M.C., Meydani, S.N. (2014): Yogurt: Role in healthy and active aging. *American Journal of Clinical Nutrition*, 99(5), pp. 1263S–1270S.
- Gibson, G.R., Roberfroid, M.B. (1995): Dietary modulation of the human colonic microbiota: Introducing the concept of prebiotics. *Journal of Nutrition*, 125, pp. 1401–1412.
- Jain, S., Yadav, H., Sinha, P.R. (2009): Probiotic dahi containing *Lactobacillus casei* protects against Salmonella enteritidis infection and modulates immune response in mice. *Journal of Medicinal Food*, 12(3), pp. 576–583.
- Kip, P., Meyer, D., Jellema, R. H. (2006): Inulins improve sensoric and textural properties of low-fat yoghurts. *International Dairy Journal*, 16, pp. 1098–1103.
- Li, W., Yang, Z., Talashek, T. (2012): Blends for fermented milk products. *US Patents* 20130059032 Ai.
- Marwa, M., Desouky, N., Soliman, H., Salama, H. (2015): The Effect of Using Cereals on the Quality of Fermented Camels' Milk Products, *Research Journal of Pharmaceutical, Biological and Chemical Sciences*, 1-2, pp. 1484-1497.
- Michaelidou, A., Steijns, J. (2006): Nutritional and technological aspects of minor bioactive components in milk and whey: Growth factors, vitamins and nucleotides. *International Dairy Journal*, 16, pp. 1421–142
- Palframan, R. J., Gibson, G. R., Rastall, R. A. (2002): Effect of pH and dose on the growth of gut bacteria on prebiotic carbohydrates in vitro. *Anaerobe*, 8, pp. 287-292.
- Parvez, S., Malik, K.A., Ah Kang, S., Kim, H.Y. (2006): Probiotics and their fermented food products are beneficial for health. *Journal of Applied Microbiology*, 100, pp. 1171–1185.
- Parvez, S., Malik, K.A., Ah Kang, S., Kim, H.Y. (2006): Probiotics and their fermented food products are beneficial for health. *Journal of Applied Microbiology*, 100, pp. 1171–1185.
- Patel, D., Walker, M. (2004): Semi-solid cultured dairy products: Principles and applications. In: *Handbook of Food Products Manufacturing*, Hui, Y.H., Chandan, R.C., Clak, S., Cross, N., Dobbs, J., Hurst, W.J., Nollet, L.M. *et al.* (ed.), John Wiley & Sons, Inc: New York, pp. 113–124.
- Penna, A. L. B., Converti, A., de Oliveira, M. N. (2006): Simultaneous Effects of Total Solids Content, Milk Base, Heat Treatment Temperature and Sample Temperature on the Rheological Properties of Plain Stirred Yoghurt. *Food Technology and Biotechnology*, 44, pp. 515-518.
- Pepe, Q., Ventorino, V., Cavella, S., Fagnano, M., Brugno, R. (2013): Prebiotic content of bread prepared with flour from immature wheat grain and selected dextran-producing lactic acid bacteria. *Applied Environmental Microbiology*, 79 (12). pp.3779-3785.
- Puniya, A.K., Aanjeev, K., Puniya, M., Malik, R. (2015): *Fermented milk and dairy Products. An Overview*: CRC Press, Taylor and Francis Group, pp. 340-350.
- Steijns, J.M. (2008). Dairy products and health: Focus on their constituents or on the matrix? *International Dairy Journal*, 18, pp. 425–435.
- Toma, M.M., Pokrotnieks, J. (2006): Probiotics as functional food: Microbiological and medical aspects. *Acta Universitatis Latviensis*, 710, pp. 117–129.

INFLUENCE OF MALTING PROCEDURE ON THE QUALITY OF HULLESS BARLEY MALT

UDC 663.439(497.5)

*Vinko Krstanović, Krešimir Mastanjević, Natalija Velić, Vedran Slačanac, Kristina Vacek**, Goran Gagula, Kristina Mastanjević**

*Josip Juraj Strossmayer University of Osijek, Faculty of Food Technology Osijek, Franje Kuhača 20, HR-31000 Osijek, Croatia (**Student of Faculty of Food Technology Osijek)*

**Corresponding author: kristina.mastanjevic@ptfos.hr*

ABSTRACT

This paper investigated the influence of malting procedure on quality indicators of hulless (naked) barley malt according to the recommended values for standard pale malt. The aim was to determine the optimal malting procedure in order to achieve the best results for investigated indicators in relation to the recommended values. Two domestic hulless barley varieties (Matko and GZ-184) were malted and four malting procedures were applied: (A) standard procedure – control; (B) gently intensive procedure with uniform temperature increase during germination till the end of the process; (C) moderately intensive procedure with the increase of germination temperature on the second and third day, and constant germination temperature till the end of the process; (D) procedure with sudden germination temperature decrease after the first day, and constant temperature till the end of the process. The influence of four malting procedures on soluble N content in malt, total N and soluble N ratio (Kolbach index), Hartong number, friability, extract, fine/coarse difference, colour, boiled wort colour, pH, viscosity and filterability of wort, and β -glucans were investigated. Based on obtained results, and their comparison to results reported in scientific and technical literature, the efficacy of each micromalting procedure was evaluated, considering recommended values for hulless barley malt. The results indicate that the resistance to deeper modification of grain (expressed as lower water absorption during soaking grains, and as weaker friability) are the main problem that will need to be solved in the further selection processes of domestic hulless barley varieties for malting. The intensification of the process of germination should be combined with the extension of soaking time, which should lead to improvements of friability of malt and better value for other indicators of malt quality.

Keywords: Croatian hulless barley varieties, malting quality, malting procedure

INTRODUCTION

Most barley varieties are hulled. If the hull does not adhere, the barley is considered to be hull-less or hulless. One gene (NUD) determines whether or not the hulls (lemma and

palea) adhere to the grain (Taketa *et al.*, 2008). This particular barley variety, *Hordeum vulgare* L. var. *nudum* Hook. f. has a loosely attached hull and during harvest the hull falls off by itself which makes the further processing much easier and more economy friendly reducing germ damage and flour loss during milling. This interest in development of new varieties of hullless barley started in the 1970' in Canada. Firstly, this kind of barley was used as stock feed, and then it became interesting for human nutrition and expanded as a new raw material for malt in brewing and distilled products (drink such as Scotch). Croatian agro-science also tried to keep up with the trends and during this period a variety "Osječki golozrni" was created, but it did not make it to production. Currently, there is only one Croatian variety of hullless barley, named Matko, but some new varieties are being developed at Agronomic Institute in Osijek. Hullless barley is also well known for its positive physiological effects and recognized as functional food. It has abundance of dietary fibre, and it is also rich in mineral elements, such as calcium, phosphorus, iron, copper, zinc, and selenium, materials which play a vital role in promoting human health. Nevertheless, its application in brewing industry is still a novelty and was firstly introduced with the development of new varieties with desirable malting properties. In short, the most important advantage of hullless barley usage in brewing industry is the economical aspect since hullless barley significantly increases malt extract 5–7 % (minimally > 2) respectively to hulled barley (Kerry & Barr, 1995; Edney & Langrell, 2004; Zhou *et al.*, 2012; Evans *et al.*, 2014; Rossnagel *et al.*, 2012). Approximately 90 % of this increase is caused because the hull is absent (hull makes 10 % of dry matter loss in barley grains) (Rennecke & Sommer, 1979). The lack of hull during mashing helps in eliminating the extraction of specific polysaccharides from hulls, which have been identified to cause premature yeast flocculation during fermentation (Edney & Langrell, 2004). Spent grain amount is also reduced with the use of hullless malt. Thus, multiple application of hullless barley are possible in malting and brewing processes. Improvements in beer quality may be possible due the absence of undesirable hull compounds such as tannins and other polyphenols. In the past, the use of hullless malt has been restricted because intact hulls affected the efficiency of lautering operation. However, with the advent of newer technologies for spent grain separation, such as mash filters and centrifuges, there has been increased interest in the advantages of hullless barley malt (Evans *et al.*, 2014). Alongside listed benefits of hullless barley usage in malting and brewing, there are also some disadvantages: the malting of hullless barley, however, presents a number of challenges due to differences in chemical and physical characteristics; the missing hull makes the barley susceptible to embryo damage during handling and malting; the loss of embryo, at an inopportune time, can prevent adequate endosperm modification. Poor, unacceptable modification has been a major concern (Evans *et al.*, 2014), which could be related to embryo loss and a resulting poor or incomplete germination (Box & Barr, 1999). Poorly modified or incompletely degraded grains are related to many undesirable quality characteristics of dry malt (Edney & Langrell, 2004; Evans *et al.*, 2014). The poor modifications observed in malt obtained from hullless barley could explain some of the reduced level of extract, since unmodified cell walls are known to restrict starch hydrolysis and, therefore, the solubilization of starch during mashing (Evans *et al.*, 1999). Friability values for malt from hullless barley have been much lower than the values acceptable for

hulled barley malt (Edney & Langrell, 2004). Furthermore, water uptake during steeping is much quicker in hulless barley than in hulled (covered) barley (Sing & Sosulski (1985). Bhatti (1986) also found hulless barley to be harder than hulled malting barley; standard malting conditions have to be altered in order to adequately process hard, steely barley and prolonged steeping and germination times may be required. Kilning step may also cause a problem. Without the protection of a hull, high kilning temperatures may cause hulless malt to become extra hard. The effects of modified malting conditions applied to two domestic hulless barley varieties (Matko and GZ 184) were investigated in this paper. Four malting procedures were applied: (A) standard procedure – control; (B) gently intensive procedure with uniform temperature increase during germination till the end of the process; (C) moderately intensive procedure with the increase of germination temperature on the second and third day, and constant germination temperature till the end of the process; (D) procedure with sudden germination temperature decrease after the first day, and constant temperature till the end of the process. Considering the stated information, this research was to assess the quality of available varieties of hulless barley from the brewing point of view and to assess how will these varieties respond to changes in process parameters during the malting process considering the set values of quality indicators of standard dry malt.

MATERIALS AND METHODS

Hulless barley samples were obtained from field trials of the Institute of Agriculture Osijek in 2013, 10 kg of each variety (Matko and GZ-184). Grain samples were collected as untreated and conditioned grain, scaled and packed into in double-walled paper bags (1 kg). Until micromalting the material was stored for two months in a dry and cool place (20 °C) to overcome post-harvest grain dormancy. Determination of standard starting quality indicators of this barley varieties was conducted in the laboratory of the Institute of Agriculture Osijek. β -glucan content was determined in the Laboratory for cereal technology at the Faculty of Food Technology Osijek. Micromalting procedure was performed according to MEBAK (MEBAK, 2.5.3.1.) in order to determine the brewing quality of selected varieties and was conducted in the micromalting plant Joe White Malting Systems (Pty. Limited East Melbourne, Victoria, Australia; Automatic Micro Malt Unit, 10 kg capacity). Degermination of dry malt was performed manually. This malting procedure was tagged as (A), control sample. Four kg of each barley variety was micromalted and after the micromalting malt samples were weighed on 500 g samples and stored in paper bags for one month in order to stabilize. Same samples served for three more modified micromalting procedures (B, C and D) in order to asses dry malt quality when applying different process conditions. These micromalting procedures were conducted in the same micromalting plant, and the germination process temperatures are displayed in Fig. 1. Germination was conducted in Climatic test chamber (Climacell 222, Medcenter Einrichtungen GmbH). Modified Micromalting were conducted according to MEBAK, but dependent on case to case, the last steeping (third day) can also be considered as the first day of germination. This applies in cases the grain cannot endure three steeping days (in this case the third steeping meant that the grain moisture was adjusted by

sprinkling in the germination chamber). The humidity in the beginning of germination was set to 45 % (44 % + 1% surface water). It is useful to mention that the modified malting procedures is actually a simulation of process parameters adjustment in the industrial scale. This implies adjustment to starting raw material quality in order to obtain the best malt possible. Procedures are modified in the germination phase. As this is the first research of this kind for Croatian hulless barley varieties, the modification procedures in this paper were set to the extreme values (B) and (C). It was assumed that the hulless barley is more like wheat, so the procedure for wheat micromalting was applied (Sacher, 1998; Narziß, 1999).

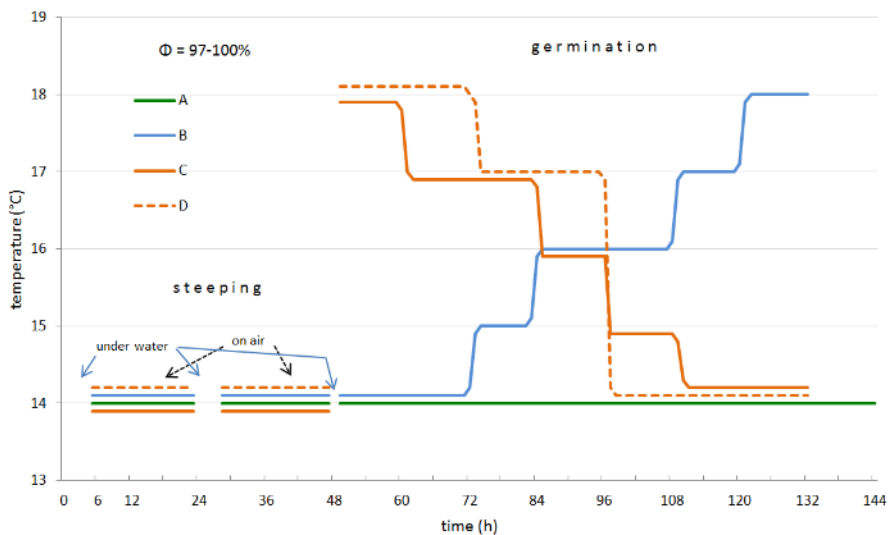

Figure 1. Micromalting scheme of hulless barley samples.

This is actually the standard procedure for barley (MEBAK, 2.5.3.1.) but with slight modification of steeping time and air humidity during germination 95 % (± 1 %) because hulless barley soaks up water much quicker than barley. Humidity decrease helps to avoid possible draining of the piles (the possibility of uncontrolled increase of moisture of germinating grain is prevented). Uncontrolled moisture increase of grains affects almost all quality indicators. Problems related with malting of hulless barley are that it is much harder than wheat and it has much lower friability than hulled barley. This is why moisture of piles was set to be 95 %, while germination time (longer in this case in order to obtain a better grain degradation) was not changed. The end of germination was determined visually after the third day (according to the length of acrospires). This way of germination control is essential in order to stop the appearance of hussars (>3 %) and

to enable the grains to germinate uniformly. The leading idea for the application of procedures shown in Fig. 1 was to, by the usage of restrictive procedure B (increasing germination temperatures) and the intense procedure C (decreasing germination temperatures), assess the behaviour of each variety during malting procedure and to notice its resistance in maintaining the key variety trait (i.e. enhanced tendency for proteolysis and cytolysis) under different malting conditions. If a variety is more inclined to higher proteolysis during standard micromalting procedure A, than this trait will be even more expressed during micromalting procedure C. Contrary, the same variety will give satisfactory values for quality indicators if procedure B is applied during micromalting. The same can be applied inversely on a certain indicator which is connected with a certain property, for example the suitability of variety for cytolytic degradation (viscosity, soluble β -glucans concentration or extract difference). These results should serve as quality indicator of investigated varieties, although malting in industrial scale implies that process parameters are set to provide the best results for quality indicators of malt. As an additional contribution in order to establish the most appropriate malting scheme, a moderately intense procedure D was conducted Fig. 1. This procedure consisted of process parameters adjusted to obtain acceptable values for both quality indicator groups (proteolytic and cytolytic) Fig. 1, which are usually mutually contradictory. Dry malt samples were analysed according to EBC-Analytica in the IREX Group laboratory (STAMAG Stadlauer Malzfabrik GesmbH, A-Wien), except β -glucan content in barley samples determined using Mixed-Linkage β -Glucan kit (enzyme method) (AACCC, 2006). Four samples of 1 kg of each barley variety was malted and mean values (mean \pm SD) are shown in Tab. 2. Determination of the influence of a certain malting procedure on the chosen quality indicators was compared by Fisher's Least Significance Test ($p \leq 0.05$).

RESULTS AND DISCUSSION

As previously stated, hullless barley related problems are connected with cytolytic degradation and are directly related with β -glucan content. If we compare β -glucan content in both barley varieties tested in this research (Tab. 1) and their malts (Tab. 2), it is visible that β -glucan content is much higher in malts, than in starting barley. β -glucan content is significantly influenced by germination procedures A and D for GZ-184 variety, while B and C procedures did not cause any significant changes in β -glucan content. Matko's β -glucan content does not appear to be influenced by malting procedure in any of the applied procedures (Tab. 2).

On the other hand, if we compare β -glucan and friability values for each variety (Tab. 2), the influence of germination procedure is more visible. Namely, viscosity values are connected with friability values, meaning that higher friability values make wort viscosity lower. This indicates the connection of deeper grain degradation with different components which cause the increase of wort viscosity values (β -glucans, pentosanes, residual starch) which is in accordance with previous research (Sing & Sosulski, 1985; Evans *et al.*, 1999; Evans *et al.*, 2014;).

Table 1. Quality characteristics of hulless barley cultivars (GZ- 183 and Matko, harvest 2013)

Physical analysis:		GZ - 184	Matko	
1.	Grain	- above 2.8 mm (%)	74.2	77.4
		- above 2.5 mm (%)	22.3	26.2
		- I class	94.3	91.0
2.	Thousand corn weight (g dry wt.)			
3.	Filtth (%)		1.72	2.06
Physiological analysis:				
5.	Germinative energy (3 days)		96	98
6.	Germinative energy (5 days)		99	99
Chemical analysis:				
7.	Moisture content of grain (%)		11.64	11.38
8.	Total proteins (% dm) f=5.7		13.80	13.20
9.	β -glucan (g/100 g dm)		4.05	4.62
10.	Starch content (%)		61.80	62.00

Lowest, more acceptable values for viscosity are obtained using procedures A and D for hulless barley GZ-184 (Tab. 2). These values stand out from values obtained from other applied malting procedures since they all caused higher viscosity values. Tab. 2 shows the narrow connection of β -glucan content and viscosity in a way that the lower β -glucan content, the lower the viscosity. This is also in accordance with previous research (Zhou *et al.*, 2012; Evans *et al.*, 2014).

Extract difference of fine and coarse grind is an indirect measure of malt modification (Briggs, 1998). A significant difference between malt extracts indicates the presence of large parts of non-degraded endosperm which have lower enzyme activity (giving lower wort quality). Extract difference also follows friability in a way that the increase of friability causes extract difference decrease and, consequently, congress wort viscosity decrease. It is interesting to notice that in regards to wheat, hulless barley has a much lower friability values (Bhatty, 1986) even though its water absorption is much better. This clearly indicates the existence of hardly degradable endosperm zones, even with such good grain moisture which should enable good enzyme activity. Hartong number (VZ 45 °C) is an indicator of enzyme activity at 45 °C (mainly cytolytic and proteolytic enzymes).

Table 2 Malt quality indicator analysis

		Micromalting procedure							
		A		B		C		D	
Indicator / unit →	Varieties	Matko	GZ-184	Matko	GZ-184	Matko	GZ-184	Matko	GZ-184
1.	Moisture content (%)	8.4	8.4	9	8.6	8.9	9.2	8.9	8.9
2.	Fine grinde extract (% dm)	69.4	82	60.6	68.8	59.7	70.3	70.6	80.5
3.	Coarse grind extract (% dm)	58.4	78.5	47.6	62.3	45.6	64.2	65	77.9
4.	Extract difference (%)	9 ^{c*}	3.5 ^f	13 ^b	6.5 ^d	14.1 ^a	6.1 ^{de}	5.6 ^e	2.6 ^f
5.	Saccharification rate (min)	15	15	60	20	60	20	20	15
6.	Clarity of wort (EBC unit)	4	1	4	4	4	4	5	1
7.	Attenuation limit (%)	78.5	80.0	66.5	72.8	71.1	77.4	79.3	79.8
8.	Filtration time (min)	R	R	L	R	L	R	R	R
9.	Odour of mash	N	N	N	N	N	N	N	N
10.	Protein (% dm) f=6.25	13.1 ^b	12.3 ^d	13.4 ^b	13 ^b	13.4 ^{ab}	13.4 ^{ab}	13.4 ^a	12.6 ^c
11.	Nitrogen (% dm)	2.1	1.97	2.14	2.08	2.14	2.14	2.14	2.02
12.	Soluble protein (% dm)	3.4 ^c	4.9 ^a	2.6 ^d	3.6 ^c	2.4 ^d	3.9 ^b	4.1 ^b	5.1 ^a
13.	Soluble nitrogen (g/100 g dm)	0.55	0.78	0.42	0.58	0.38	0.63	0.66	0.82
14.	FAN (mg/L)	117	174	86	126	83	133	150	204
15.	Hartong VZ 45 (%)	33.9 ^{bc}	48.1 ^a	24.7 ^d	34.3 ^c	25 ^d	33 ^c	39.5 ^b	48.4 ^a
16.	Kolbach index (%)	26 ^d	40 ^b	20 ^e	28 ^c	18 ^f	29 ^c	31 ^c	41 ^a
17.	Colour of wort (EBC unit)	3	2.6	2.5	2.7	2.4	2.6	3.1	2.9
18.	Colour after cooking (EBC unit)	3.5	5	2.8	3	2.8	3.3	4	6.2
19.	Viscosity (mPa×s. 8.6%e)	2.17 ^a	1.65 ^d	2.17 ^a	2.15 ^a	2.17 ^a	1.9 ^b	1.78 ^c	1.62 ^d
20.	Friability (%)	29 ^b	35 ^a	19 ^{de}	24 ^c	18 ^e	21 ^d	31 ^b	35 ^a
21.	Glassy grains (%)	*	*	*	*	*	*	*	*
22.	Partly glassy grains (%)	*	*	*	*	*	*	*	*
23.	β-glucan (mg/L)	500 ^a	320 ^b	500 ^a	500 ^a	500 ^a	500 ^a	500 ^a	355 ^b

* due to extreme low friability nearly all grains could be rated as glassy or partly glassy

**Mean values followed by the same letter in the same row are not significantly different (LSD) test ($p < 0.05$)

***R – regular; L– lower; N – normal

This research showed optimal Hartong number when using B and C procedures. With the decrease of β-glucan content (better degradation of β-glucan), VZ 45 °C values showed an increase in A and D procedures (Tab. 2). Malt extract is usually a basic economic indicator

of malting procedure and grain quality, representing all water-soluble components (fermentable and non-fermentable) transferring to wort during mashing. Tab. 2 shows that less extract was obtained with the increase of β -glucan content. Malting procedures, A and D of GZ-184 variety (2 and 8) gave higher extract values and β -glucan content was lower. Saccharification rate was optimal for all malting procedures, except procedures B and C for Matko variety where saccharification rate lasts longer (Tab. 2). When looking at proteolytic degradation indicators, a relatively high total protein content in barley and malt (Tab. 1 and Tab. 2) is followed by very low soluble proteins content. Low soluble proteins content can be caused by weak grain degradation (low friability) which in consequence lowers the values of many malt quality indicators. Soluble proteins and FAN content of obtained malts show that both indicators are suitable for both varieties, except in malting procedures A and D for GZ-184 (Tab. 2).

CONCLUSIONS

The resistance to a deeper grain modification (expressed as weaker water absorption in steeping phase and lower friability values) is obviously the core problem and it will need to be dealt with when selecting new hulless barley varieties for malting industry. The intensification of malting procedures made no significant alterations of chosen quality indicators. High β -glucan content is a reason for weaker water absorption in some zones of the endosperm and a lower enzyme activity which makes the grain poorly modified during malting. This directly distorts all other indicators related with friability (extract, extract difference, Kolbach index, Hartong number and wort viscosity). The intensification of germination procedure should be combined with the extent of steeping time which should affect the overall malt quality indicators, including the friability.

REFERENCES

- AACC - Approved Methods of Analysis 11th Edition, Method 32-23.01. Beta-Glucan Content of Barley and Oats - Rapid Enzymatic Procedure.
- Bhatty, R.S. (1986): The Potential of Hull-less Barley – A Review. *Cereal Chem.* 63 (2) 97-103.
- Box, A.J., Barr, A.R. (1999): Hulless barley in Australia - The potential and progress. Proceedings of the 8th Australian Barley Technical Symposium, Queensland, AUS, pp. 11-19.
- Briggs, D.E. (1998): Malts and Malting. Blackie Academic and Professional. London. pp. 602.
- EBC (European Brewery Convention, Analytica 5. ed.), 1998 Nürnberg, Fachverlag Hans Carl, D-Nürnberg.
- Edney, M.J., Langrell, D. E. (2004): Evaluating the malting quality of hulless CDC Dawn, Acid-Dehusked Harrington, and Harrington Barley, *J. Am. Soc. Brew. Chem.* 62, (1), 18-22

- Evans E., Vilpola A., Stewart, D.C., Stenholm, K., Poyri, S., Washington, J.M., Barr, A.R., Home, S. (1999): Pilot scale investigation of the importance of the barley husk for mash filtration. The Technical Quarterl of Master Brewers Association of Americas 36, 375-382
- Evans, D.E., Stenholm, K., Vilpola, A., Home, S., Hughes, G., Evans, E., Vilpola, A., Stewart, D.C., Stenholm, K., Pöyri, S., Washington, J.M., Barr, A.R., Home, S. (2014): Producing a Quality Malt from Hulless Barley. MBAA Technical Quarterly 35, 189 The American Society of Brewing Chemists. pp. 375-382.
- Kerry, J.A., Barr, A.R. (1995): Genetic variation in Key Malting Quality Traits in Hulless Barley. 7th Australian Barley Symposium pp. 266-268
- MEBAK (Middle European Brewing Analysis Commission), Brautechnische Analysenmethoden 3. ed. Band I (1997) and Band II (1993), Selbstverlag der MEBAK Freising-Weihenstephan).
- Narziss L. (1999): Die Bierbrauerei: band I: Die Technologie Der Malzbereitung, 7 ed., F. Enke Verlag, Stuttgart, pp.25-65, 422-429.
- Rennecke D., Sommer W. (1979): Use of naked barley in the brewing and malting process. *Lebensmittelindustrie* 26, 66-68.
- Rosnagel, B. G., Legge, W., Edney, M., Beattie, A., Scoles, G. (2012): 5% > extract and more \$ for brewers—Hulless barley malt a dramatic difference. American society of Brewing Chemists & Master Brewers Association of the Americas, Proceedings of the 2012 World Brewing Congress, Oregon, Portland, USA, pp. 151.
- Sacher B. (1998): Trials for the optimisation of use of soft-wheat varieties in malting and brewing. Dissertation, TU München-Weihenstephan., pp 43-48, pp 173-179.
- Sing, T., Sosulski, F.W. (1985): Malting of hulless barley cultivar and Glenlea (*T. aestivum*) utility wheat. *J. Food Sci.* 50, 342-346.
- Taketa, S., Amano, S., Tsujino, Y., Sato, T., Saisho, D., Kakeda, K., Nomura, M., Suzuki, S., Matsumoto, T., Sato S., Kanamori, H., Kawasaki, S., Takeda, K. (2008): Barley grain with adhering hulls is controlled by an ERF family transcription factor gene regulating a lipid biosynthesis pathway. Proceedings of the National Academy of Sciences of the United States of America 105(10), pp .4062-4067.
- Zhou, G., Wang, S., Zhang, N., Xu, Z. (2012): Research on malting technology of hulless barley used for brewing hulless barley beer. Malt and grain session 157, Proceedings of the World Brewing Congress, Portland, Oregon, U.S.A.

ACORN FLOUR – NATURALLY GLUTEN FREE

UDC 664.641.4 : 582.632.2

Mirjana Polimac^{1*}, *Daliborka Koceva Komlenić*²

¹*Ivana Gorana Kovačića 6, HR- 31000 Osijek, Croatia*

^{*}*Corresponding author: mpolimac@lycos.com*

²*Josip Juraj Strossmayer University of Osijek, Faculty of Food Technology Osijek, Franje Kuhača 20, HR-31000 Osijek, Croatia*

ABSTRACT

Gluten intake causes gastrointestinal disorders in celiac and intolerant patients. The current trend of consuming gluten free products has added to the demand for these industry products. Digestive health reasons, weight management, and nutritive value of these foods are some of the reasons that have been driving the gluten-free products market. Manufacture of gluten-free products requires the use of preselected raw materials. The number of such ingredients is limited; therefore, the acorns could become one major food source and an attractive novel ingredient for the future. The objective of this paper was to perform and document a complete production cycle of acorn flour starting from the foraged tree nuts, collected in October in Slavonia (east Croatia). The results of physical and chemical investigations of differently treated samples of oak acorn are also presented in this paper. Oak acorn, *Quercus robur* L., (belonging to *Fagaceae* family) was investigated in native and thermally treated forms. The acorns were allowed to dry naturally and then shelled. The meal was coarsely ground and dried at 40 °C for 24 h and milled. Produced acorn flour contains 4.56 % fat, 6.48 %, protein, 36.86 % hemicellulose, 14 % cellulose and 1.96 % minerals.

Keywords: gluten free products, oak acorn, acorn flour

INTRODUCTION

For thousands of years acorns, the fruit of oak trees, have been a staple food throughout North America, Asia, the Middle-East, North Africa and Europe (Bainbridge, 2006; Grlić, 2005; S. L. R. L. R. Mason, 2000; Revedin *et al.*, 2010). However, nowadays they have almost disappeared as a food for human consumption. Recent interest in foraging for wild food and increasing environmental awareness, as well as the search for health and wellbeing through balanced nutrition, would also represent a strong argument for inclusion of acorns in cooking. Commercial acorn processing today is mainly limited to countries such as Korea, China and to a lesser extent, the U.S.A. (Bainbridge, 2006).

Besides linking to ancient culinary tradition and foraging, using acorn flour is desirable from a nutritional point of view, because of content of fat (of which over 80 % is unsaturated), proteins and considerable amount of electrolytes (calcium, magnesium, potassium and phosphorus), but little or no sodium, and is rich in iron, copper and zinc. Acorn meal could be a nutritionally functional ingredient in foods that use wheat flour such as cookies, muffins, breads, bars, noodles, pastries, bread and deserts (Sabrin, n.d.) Functional foods are value-added foods that have been shown to have a growing presence in the food industry. Availability of foods that contribute to health benefits and disease prevention is a great tool for nutritionists to employ when trying to improve the eating habits of individual clients and the general population. Acorns have been an important part of traditional diets of people throughout the world and are reported to have potential health benefits (Tadayoni *et al.*, 2015), (Rakić *et al.*, 2006).

The objective of this study was to perform and document a whole production cycle of acorn flour starting from the foraged tree nuts collected in October 2014 by local forestry enterprise from eastern Croatia.

Materials and Methods

Plant Material

The representative sample used in this investigation was the oak acorn (*Quercus robur L.*, which belongs to the *Fagaceae* family). The acorns used to produce the acorn flour were gathered during the second week in October 2014. The collected acorns were inspected in order to remove rotten and infested specimens. Remaining acorns were then allowed to dry naturally by spreading them in a single layer outside on the table during sunny days for approximately 10 days. The acorn flour did not undergo any treatment that would greatly alter the nutritional composition of the acorn, once shelled.

Production of Acorn Flour

After the drying period, acorns were manually shelled with a nutcracker. The skin remaining on the outside of the fruit bodies was then removed by mechanic peeling. The shelled and peeled acorn kernels were roughly ground in a food processor Braun MC1 for 1 minute at speed 2. Grounded kernels were spread evenly onto baking paper and placed in a food dehydrator (Gorenje FDK24DW) for 24 hours at 40 °C. After the drying process was completed the product was placed in a mill and ground into a fine meal (Lab Mill IKA MF10), ready to be used in cooking and baking applications.

RESULTS AND DISCUSSION

The following is an overview of the results of the analyzed samples of acorn flour.

The breakdown of yields during the processing steps is displayed in Table 1. The yield percentage of flour, after processing from whole acorns to acorn flour, was 54.59 %.

Table 1. Product yields during processing

Product	Weight	Percentage of initial total
Acorns Whole	3984 g	100.00 %
Acorns shelled and skinned	2634 g	66.11 %
Acorn flour	2175 g	54.59 %

The results of physicochemical analyzes are presented as follows:

Table 2. Characteristics of the analyzed samples

Sample	Treatment	Appearance
Sample 1	Dried and milled nut	Light brown powder
Sample 2	Thermally treated ground nut at 170 °C (10 min)	Brown powder

Table 3. Characteristics of the analyzed sample

Sample	Moisture (%)	Ash (%)	Fat (%)	Proteins (%)
Sample 1 (dried)	9.45	1.86	4.44	6.35
Sample 2 (thermally treated)	3.51	2.06	4.67	6.61

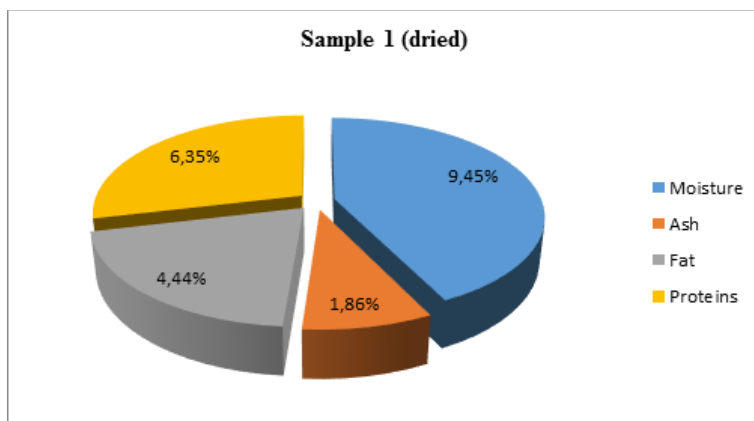

Figure 1. Characteristics of the analyzed dried acorn flour

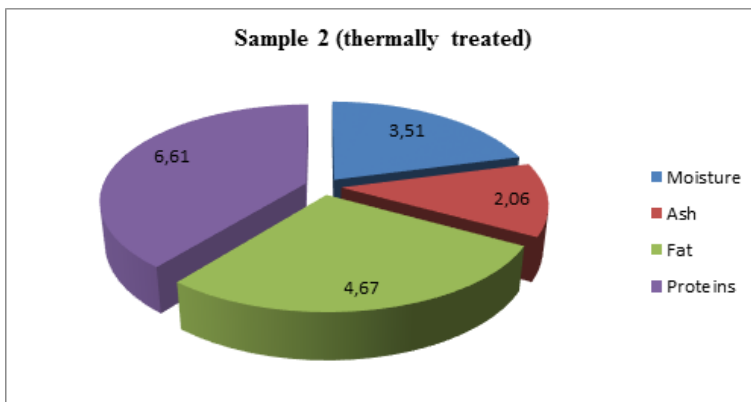

Figure 2. Characteristics of the analyzed thermally treated acorn flour

According to the results of physicochemical investigations of differently treated samples of scorn flour (Table 3, Figure 1 and 2) it was possible to conclude that there is no significant difference between row and thermally treated samples of flour in composition of fat, proteins or ash, except of moisture, and appearance. On average, produced acorn flour contains 4.56 % fat, 6.48 % protein, 36.86 % hemicellulose, 14 % cellulose and 1.96 % ash as showed on Figure 3.

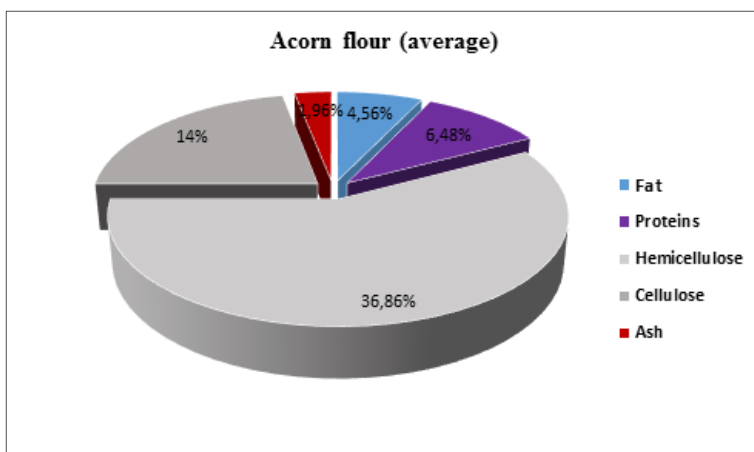

Figure 3. Characteristics of the analyzed acorn flour (average)

CONCLUSIONS

Produced pedunculate oak (*Quercus robur* L.) acorn flour contains on average 4.56 % fat, 6.48 % protein, 36.86 %, hemicellulose, 14 % cellulose and 1.96 % ash. There is no significant difference between row and thermally treated samples of flour in composition of fat, proteins or ash, except of moisture. The yield percentage of acorn flour, after processing from whole acorns to acorn flour, was 54.59 %. Finally, acorn flour produced from foraged pedunculate oak acorns is suitable for home production and use in a variety of bakery products.

REFERENCES

- Bainbridge, D. a., 2006. Acorns as Food , (January), pp.1–32. Available at https://www.academia.edu/3829415/Acorns_as_Food_Text_and_Bibliography.
- Grić, L., 2005. Enciklopedija samoniklog jestivog bilja Treće izda., Rijeka: Rijeka: Ex libris, 2005 - (Biblioteka Natura; knj. 1).
- Mason, S.L.R.L.R., 2000. Fire and Mesolithic subsistence — managing oaks for acorns in northwest Europe? *Palaeogeography, Palaeoclimatology, Palaeoecology*, 164(1-4), pp.139–150. Available at <http://www.sciencedirect.com/science/article/pii/S0031018200001814> [Accessed July 20, 2015].
- Rakić, S. *et al.*, 2006. Oak acorn, polyphenols and antioxidant activity in functional food. *Journal of Food Engineering*, 74(3), pp.416–423. Available at <http://www.scopus.com/inward/record.url?eid=2-s2.0-31644432659&partnerID=tZOtx3y1> [Accessed June 6, 2015].
- Tadayoni, M., Sheikh-Zeinoddin, M. & Soleimani-Zad, S., 2015. Isolation of bioactive polysaccharide from acorn and evaluation of its functional properties. *International Journal of Biological Macromolecules*, 72, pp.179–184. Available at <http://search.ebscohost.com/login.aspx?direct=true&db=ffh&AN=2015-04-Js2581&lang=hr&site=ehost-live>.

WHEAT GRAIN CONSERVATION FOR HUMAN CONSUMPTION: CURRENT USE OF PESTICIDES IN ARGENTINA (REVIEW ARTICLE)

UDC 633.11 : 632.95.024(82)

Teresa Fonovich^{1*}, Valeria Sfara², Cristina Pérez-Coll^{1,2}

¹School of Science and Technology, National University of San Martín, San Martín, Argentina

*Corresponding author: tfonovic@unsam.edu.ar

²Environmental Engineering and Research Institute, National University of San Martín, (1650) San Martín, Argentina.

ABSTRACT

Grain storage constitutes a critical point in cereal production. There is an increasing tendency to leave the concept of “commodity” and treat grain production as “food”, mostly considering its safety, due to grain quality, integrity and absence of pesticide residues. New generation pesticides are less but still toxic substances. Fenitrothion, mercaptothion, chlorpyrifos, dichlorvos, deltamethrin, phosphine and warfarins are still in use for storage in conventional silo. Wheat is usually affected by fungi, which begin to grow on cultures before harvest and afterwards by mite and insects. Silobags have great advantages when compared to conventional silo, like an important decrease in the need of pesticide use. Adverse effects evaluated on human health in relation to grain storage must consider not only people consuming grain, flour and food products but also workers exposure. Occupational disease associated to grain storage consists of allergy and respiratory diseases, due to exposure to dust, mould and pesticides. Residues control taking place nowadays and new technologies have led to residues level below established limits, as occurs with the fungicide tebuconazole applied on wheat in the field. Diatomaceous earth insect control during grain storage is replacing traditional pesticide control because of its effectiveness and safety.

Keywords: wheat grain; pesticides; occupational disease; human exposure.

INTRODUCTION

Agriculture in Argentina is principally based on the production of soya bean, corn, wheat, sunflower, peanut, stone fruit, citric, pastures, vegetables, potato, cotton, tobacco, pip fruit, sugar cane, rice, grape, bean and others (Villaamil Lepori *et al.*, 2013). Although in the past wheat production was the most important one both for consumption at the local market and for export, nowadays soya bean production and sale have increased substantially and exceeded the ones for wheat and corn. Transgenic soya bean is being cultured all over the country and fertilizers as well as the herbicide glyphosate are nowadays the agrochemicals mostly used (Satorre, 2005). Glyphosate was classified as a

probable carcinogen by IARC and is toxic to many living organisms (International Agency for Research in Cancer, 2015). On the other hand, other toxic agrochemicals use has declined as the consequence of no-till farming, but they are still being detected and quantified in food and water sources.

Soya bean production is often intercalated with wheat and corn ones through no-till farming. Having advantages and disadvantages, farmers adopted this type of farming mostly due to higher prices and the possibility of soya bean culture at a wide range of latitudes and climates. The most powerful benefit of no-tillage is improvement in soil biological fertility, by making soils more resilient. However, nutrients as phosphorus, nitrogen and sulfur have to be added to soils were soya bean and wheat cultures take place one after the other (García *et al*, 2001), but their addition is usually not enough to replace the nutrients extracted from the soil by the grain. Farm operations are much more efficient, particularly though improved time of sowing and better trafficability of farm operations. Wheat production has been recently considered as a culture of low risk for the environment, according to the low level and toxicity of agrochemicals used in the field.

Silo-bag is another new technology that has been adopted all over our country because of its advantages on the maintenance of grain integrity, which also has contributed to decrease pesticides use at this stage of cereal production (Ricca *et al*, 2014). However, some organophosphate pesticides and other chemical compounds belonging to old generation group, as Fenitrothion, mercaptotion, chlorpyrifos, dichlorvos, deltamethrin, phosphine and warfarins, are still in use, but mostly in conventional silo storage.

Organophosphate pesticide adverse effects on human health have been monitored in rural workers through blood cholinesterase activities determination. Seasonal strong inhibition was reported by different authors. Organochlorinated and pyrethrin like pesticides toxic effects are exerted on the nervous system of living organisms. Warfarin and some derivatives are well known anticoagulant compounds and phosphine toxicity to mammals consist on impairment in vascular and respiratory systems.

The aim of the present work is to deal with the toxicity of pesticides used for wheat grain protection, both in the field and during storage, mainly in silo-bag but also at conventional silo.

Wheat production and storage

Wheat sowing in Argentina is a complementary activity to soya bean production, through no-till farming. However, its production during 2010/2011 and 2012/2013 campaigns contributed only to 2.5 % and 1.2 % respectively of the total world wheat production. Thus, Argentina reached in these years the 11th and 14th places between world wheat producing countries (Calzada and Rossi, 2013). Sowed surface for wheat, corn and soya bean in the last two campaigns can be seen in table 1 (GEA, 2015). Argentina is an important silo-bag manufacturer, not only for local market but also for clients in 32 countries around the world. 40 % of Argentinean grain production is stored in silo-bags (Cuniberti, 2014). This kind of storage has some important advantages to grain producers, mostly through

important decrease in costs. First, the cost derived from transportation, as they place silo-bags at their own fields. And then, the cost of plague control through the use of pesticides, as silo-bags provide worse conditions for insects, mites and microorganisms development (Ricca *et al*, 2014). Fungi, bacteria and yeast grow at moisture % over 14. Storage at this moisture content during 60 days is adequate both for grain integrity and gluten properties maintenance. Aerobic microorganism development is not favoured because oxygen content is less than 20 % in silo-bag atmosphere. Temperature is always below 35 °C in silo-bags thus, anaerobic microorganisms do not develop in this environment (Cuniberti, 2014).

Table 1. Grain production estimation according to GEA (Strategic Guide for Farmland).

Grain	Campaign	Sowed Surface (million ha)	Production (million Tn)
Wheat	2015/2016	3.4	----
	2014/2015	4.6	12.8
Soya bean	2014/2015	20.2	60.1
	2013/2014	20.2	55.6
Corn	2014/2015	4.1	25.8
	2013/2014	4.8	27.5

Pesticides used for wheat culture and stored grain protection

Most common diseases affecting wheat plants grow are caused by fungi on their leaves. However *Ustilago tritici* and *Tilletia phoetida* affect wheat seed. Insect preferentially affecting wheat are aphids, which need for control depends on climate, as they only develop well in dry seasons. They reduce yields through removing great quantities of sap from the plants. Some insect larvae eat leaves and stems. Other pests affecting wheat sporadically are weevil, worms and mites (Dow Agrosiences, 2015). Wheat grain production is also affected by weeds. Different pesticides have to be applied on the field to prevent crop losses. Local branches of multinational manufacturer companies provide clopyralid plus 2,4-D, aminopyralid plus metsulfuron methyl and picloram plus glyphosate to control weeds; organophosphorus insecticides as dimetoato and chlorpyrifos; pyrethroid insecticides as cypermethrin and the fungicides gammalotrine, tebuconazole, azoxistrobina (estrobirulina) plus cyproconazole (triazole) and fenbuconazole.

Stored grain is protected from insects through a wide range of methods including physical (hot air current, storage at low temperature, dehydration with diatomaceous earth, etc.), biological (*Bacillus thuringiensis* and pheromones) and chemical ones. This last group consists on liquids (organophosphorus compounds: 2,2-dichlorovinyl dimethyl phosphate (DDVP), mercaptothion, pirimiphos methyl, chlorpyrifos methyl, fenitrothion, mercaptothion; pyrethroids: deltamethrin, permethrin, dichlorvos, etc.), gas

(phosphine) and solid (mercaptotion, fenitrothion and permethrin) products (Casini and Santajuliana, 2008). Anticoagulant rodenticides as warfarine and coumarin are widely used to prevent rodent attacks on silo-bags.

It is important to notice that the production, sale and/or use of some of the above mentioned pesticides (fenitrothion, warfarine, coumarin and phosphine) is forbidden in Argentina, according to Servicio Nacional de Sanidad y Calidad Agroalimentaria (SENASA) regulations (SENASA, 2015; CIPET, 2015; INTA, 2015). However, they can easily be purchased and continue to be applied in all the regions where grain is produced and stored.

Residues concentration of agrochemicals in grain must be under levels established in the legislations. New technologies have been designed to achieve this goal (FAO-OMS, 1994). On the other hand, residues of pesticides and fungicides applied on the field have been respectively quantified in corn and wheat grain from different cultivars, after 60 days of storage (Strada *et al*, 2012). They concluded that tebuconazole residues in wheat grain can persist at levels over the maximum level established in two different legislations (SENASA, Argentina and CODEX), during dry weather periods.

Diatomaceous earth use to protect stored grain is increasing because of its safety and effectiveness. New machinery has been recently designed with the purpose of making it easy to dosify this product when is added to grain stored in silo.

Most common intoxications associated to pesticides in crop producing areas

SERTOX is the Toxicology Service from the Child Hospital in the city of Rosario, which is in the province of Santa Fé and is surrounded by crop producing fields. This service regularly publishes its statistics on all the intoxications they register. For instance SERTOX have recorded and classified acute intoxications with pesticides for agricultural use between 2000 and 2004 and have recently evaluated in a retrospective study, 1.4% of the 6857 intoxications registered in that period of time (N=96). They have found that 51% of the evaluated intoxications corresponded to people between 20 and 49 years old and that 49% of them were occupational ones. Toxicants could in some cases be identified, being the most abundant organophosphate compounds, glyphosate, carbamates and others (Evangelista *et al*, 2005).

31 intoxications with phosphine were reported by SERTOX between 2000 and 2009, 20 of them of occupational origin (Piola *et al*, 2010), mostly in workers involved in terrestrial grain transportation, because of inappropriate use of this forbidden pesticide, even being lethal for three workers.

From 385 intoxications with warfarine like products reported between 1990 and 1999, 68.3 % corresponded to accidental ingestion, and 97.6% of the intoxicated ones were children between 0 and 9 years old. Thus, occupational intoxication with these products does not take place frequently, but intoxicated children may spend time near the places where these anticoagulants are stored, both for domestic or field application (Piola *et al*, 2002).

Exposure to pesticides and Occupational disease

Acute or chronic occupational intoxications with severe effects of workers health have decreased in the recent years in Argentina as the consequence of the use of new generation pesticides and new application techniques and machinery, joint to educational programs and the establishment of toxicological surveillance services. However, subclinical effects are still found and associated with exposure to pesticides.

Agricultural workers from the province of Córdoba exposed to glyphosate, cypermethrin and atrazine were subjected to a cytogenetic evaluation. The frequency of chromosomic aberrations was greater in that group than in a Control group. Other agricultural workers from the province of Santa fé and a control group were evaluated for cholinesterases activity, lipidic peroxidation and comet assay for DNA damage inhibition. The results demonstrated both alteration in redox balance and DNA damage in exposed workers. Hematologic cholinesterases and oxidative stress biomarkers were also studied in a group of workers exposed to pesticides during 10 years through fumigation activity. While enzyme activities did not show significant differences when compared to Control workers, oxidative stress biomarkers did, demonstrating subclinical effects of the pesticides (Villaamil Lepori *et al*, 2013).

CONCLUSIONS

In the recent years it became evident that new technology and the fact that Argentinean crop producers have developed and increased conscience of the risk that pesticides in use for grain (including wheat) production and storage may represent for human health and especially for workers, have lead to decreased number of intoxications as well as minor toxic effects. Nevertheless there is still missing the implementation of an adequate education program for workers at terrestrial transportation companies.

REFERENCES

- Calzada, J., Rossi, G. (2013): Commodities. Mercado mundial de trigo y su impacto para Argentina. Bolsa de Comercio de Rosario. Informativo semanal 1642, 4-7.
<http://www.bcr.com.ar/Pages/Publicaciones/infoboletinsemanal.aspx?IdArticulo=796>, accessed September 14, 2015.
- Casini, C., Santajuliana, M. (2008): Control de plagas en granos almacenados.
<http://www.cosechaypostcosecha.org/data/articulos/postcosecha/ControlPlagasGranosAlmacenados.asp>, accessed October 23, 2015.
- CIPET. Boletín técnico n° 36. (2015): El uso de fosforo de aluminio en el transporte de granos.
<http://www.cipetcatamp.com.ar/website/boletinstecnicos/boletines/CIPET%20-%20Boletin%20T%C3%A9cnico%20N%C2%BA%2036%20-%20El%20Uso%20de%20Fosforo%20de%20Aluminio%20en%20el%20Transporte%20de%20Granos.pdf>, accessed October 24, 2015.
- Cuniberti, M.B. (2014): Almacenamiento de granos (silo bolsa y calidad). Trigo. INTA (Instituto Nacional de Tecnología Agropecuaria). <http://inta.gob.ar/documentos/almacenamiento-de-granos-silo-bolsa-y-calidad/>, accessed September 14, 2015.

- Dow Agrosciences. (2015): Manual técnico Línea Trigo Dow.
<http://www.fedea.com.ar/uploads/pdf/manual-tecnico.pdf>, accessed October 21, 2015.
- Evangelista, M., Piola, J.C., Prada, D.B. (2005): Epidemiological Sertox Data of Acute Agricultural Pesticides Intoxication. Poster presentation. Congreso Argentino de Toxicología, Mendoza.
- FAO-OMS. Informe conjunto. (1994): Residuos de plaguicidas en los alimentos.
https://books.google.com.ar/books?id=xGp8jLDee-QC&pg=PA194&lpg=PA194&dq=tebuconazole+no+deja+residuos&source=bl&ots=uu48edKIXI&sig=m3aCQ_ietxEdzP9oZuTI21fH248&hl=es&sa=X&ved=0CBsQ6AEwAGoVChMIzfe5k-TbyAIVCx6QCh3hNg5l#v=onepage&q=tebuconazole%20no%20deja%20residuos&f=false, accessed October 24, 2015.
- García, F., Fontanetto, H., Vivas, H. (2001): La fertilización del doble cultivo trigo-soja. Anuario 2001 Agronomía, INTA. http://rafaela.inta.gov.ar/anuario2001/a2001_125.htm, accessed September 12, 2015.
- GEA (Guía estratégica para el agro). (2015): <https://www.bcr.com.ar/Pages/gea/estimaProd.aspx>, accessed September 14, 2015.
- INTA (Instituto Nacional de Tecnología agroalimentaria). (2015): SENASA: Listado de principios activos prohibidos o restringidos. <http://inta.gov.ar/documentos/prueba-listado-de-principios-activos-prohibidos-o-restringidos>, accessed October 24, 2015.
- International Agency for Research in Cancer. (2015): IARC Monographs on the evaluation of carcinogenic risks to humans. List of classifications, vol 1-113.
http://monographs.iarc.fr/ENG/Classification/latest_classif.php, accessed September 13, 2015.
- Piola, J.C., Prada, D.B., Cagna, B., Ezpeleta, D.C. (2002) Intoxicaciones con warfarínicos en Rosario, 1990-1999, y adecuación de normas de atención. <http://www.sertox.com.ar/modules.php?name=Content&pa=showpage&pid=164>, accessed October 24, 2015.
- Piola, J.C., Prada, D.B., Evangelista, M. (2010): Intoxicación con fosfuros/fosfina. SERTOX Monografías. <http://www.sertox.com.ar/modules.php?name=Content&pa=showpage&pid=747>, accessed October 24, 2015.
- Ricca, A., Martínez, M.J., Presello, D., Bartosik, R. (2014): Sanidad e Inocuidad de los Granos. 1er Congreso Internacional de Almacenamiento de Granos en Silo Bolsa.
<http://www.innocua.net/web/download-2119/inta-conf-9-ricca.pdf>, accessed September 13, 2015.
- Satorre, E.H. (2005): Cambios tecnológicos en la agricultura Argentina actual. *Ciencia Hoy* 15, 24-31.
- SENASA. (2015): Listado de principios activos prohibidos y/o restringidos. <http://www.msal.gov.ar/agroquimicos/pdf/prohibidos-y-restringidos.pdf>, accessed October 24, 2015.
- Strada, J., Ricca, A., Conles, M., Silva, M., Rojas, D., Casini, C., Piatti, F., Martínez, M.J. (2012): Evaluación de residuos de plaguicidas en granos de maíz (*Zea mays* L.) y trigo (*Triticum aestivum* L.) posterior a la aplicación en el almacenamiento y en el campo. *Interciencia* 37, 412-417.
- Villaamil Lepori, E.C., Bovi Mitre, G., Nassetta, M. (2013): Situación actual de la contaminación por plaguicidas en Argentina. *Rev. Int. Contam. Ambie.* 29, 25-43.

STARCH BREAKDOWN AND FORMATION OF SUGARS DURING TRITICALE GRAINS GERMINATION

UDC 664.23 : 664.64.016.8

Tatjana Rakcejeva^{1*}, *Dace Klava*¹, *Ingmars Cinkmanis*², *Ruta Galoburda*¹,
*Evita Straumite*¹, *Arta Kronberga*³

¹*Latvia University of Agriculture, Faculty of Food Technology, Department of Food Technology, LV-3001, Jelgava, Latvia*

*Corresponding author: tatjana.rakcejeva@llu.lv

²*Latvia University of Agriculture, Faculty of Food Technology, Department of Chemistry, LV-3001, Jelgava, Latvia*

³*Priekuli Plant Breeding Institute, LV-4126, Priekuli, Latvia*

ABSTRACT

Cereal products are the main part of human diet, as they contain high amount of carbohydrates, proteins, dietary fibre, and vitamins of group B. *Triticale* is a hybrid of wheat and rye. Germinated grain have already been used in food since ancient times because it is known to intensify metabolism, strengthen immunity, compensate deficiency of vitamins and mineral substances, and normalize acid and alkali balance. It is possible to predict relatively low Glycemic Index of germinated cereals in future obtaining breakfast flakes. The purpose of the investigation was to evaluate changes occurring with starch and sugars in triticale grain germination process. Triticale grains were steeped for 24 h, and then germinated for 12, 24, 36, and 48 hours ($t=35\pm 2$ °C, $RH=93\pm 2$ %). The following quality parameters were analysed: moisture content, starch content, falling number, structure of starch granules, and content of individual sugars. Moisture content of a control sample (non-germinated grain) was 13.32 ± 1 %; during steeping and germination moisture content of grains increased 3.5 till 3.7 times respectively. For obtaining germinated triticale with relatively low Glycemic Index recommended germination time is 24 h at controlled temperature and RH, in dark. During triticale grain germination for 24 h, the falling number of grain samples decreased from 63 till 62 s mainly indicating an increased enzyme activity in grains and resulting starch breakdown; starch content decreased by 6%. Due to increased α -amylase activity in analysed cereals

A-type starch granules were degraded during steeping, however, during following grain germination at controlled conditions for 12, 24, and 48 h, starch granules swelled, as a result, the diameter of A-type granules disk shape increased; B-type starch granules did not change significantly. During germination individual sugar content increased significantly. During steeping and following 24 h germination the content of simple sugars (fructose, glucose, sucrose, and maltose) increased 1.2–2.0 times.

Keywords: triticale, germination, starch, sugars

INTRODUCTION

Triticale (\times *Triticosecale*) is a hybrid of wheat (*Triticum* spp.) and rye (*Secale cereale*), which has demonstrated high yield potential even under marginal growing conditions. It can be used as a raw material for new foods. Cereal based foods are a major source of inexpensive calories and nutrients worldwide. Whole grains are also source of many phytochemicals, including phytoestrogens, phenolic compounds, antioxidants, phytic acid, and sterols which make them important in developing functional foods. Cereals contain water-soluble fibre (such as β -glucan and arabinoxylans), oligosaccharides (such as galacto- and fructo-oligosaccharides) and resistant starch, and thus have been suggested to fulfil the prebiotic concept (Mridula, 2015).

Glycemic Index and glycemic load may be important factors to investigate for the prevention and management of a variety of chronic conditions, including diabetes, obesity, and hypertension (Wang *et al.*, 2015). The GI provides an assessment of the quality of carbohydrate-containing foods based on their ability to raise blood glucose (Watanabe *et al.*, 2015). Low GI foods provoke a slower, more sustained blood sugar response, with several studies supporting an association between consuming a lower GI diet and improved glycose control (Wang *et al.*, 2015).

It is possible to predict not only elevated vitamin content but comparatively low glycemic index of germinated cereals in future obtaining several processing products such as breakfast flakes. For example, an extruded breakfast cereal made from hull-less barley cultivar has lower GI and insulaemic responses than a similar cereal made from the Torrens barley; these findings indicate significant potential to assist in improving human health (King *et al.*, 2008).

One major limiting factor in the utilization of triticale grain as food is its high α -amylase activity (AAA) prior to harvest, which is caused by wet conditions. It significantly alters the functional properties of starch, reducing its water-binding capacity and eventually the quality of ready products, as for example bread. On the other hand, high AAA can be advantageous in the production of triticale malt, which can be used as an additive in the food industry or in brewing. For malting triticale, the process of germination should be shorter, and at lower temperatures and relative humidity than generally applied for malting barley (Lelley, 2006).

Starch is the most abundant carbohydrate component in cereal grains, and it is the main form of energy stored in grains. The amount of starch contained in grain varies, but it generally is between 60 % and 75 % of the grain weight. Starch is a polymer of α -D-glucose, and can have two distinguishable types, amylose and amylopectin. The ratio of the two polysaccharides varies according to the botanical origin of the starch. For grain, amylose typically makes up 20–35 % of the total starch content. However, high amylopectin cereal grains (amylose content <15 % of total starch) are generally described as waxy since the endosperms of the first mutants discovered have a waxy appearance. There are large variations in granule size (1–100 μ m in diameter), shape (round, lenticular, polygonal), size distribution (uni- or bi-modal), association as individual (simple) or granule clusters (compound), and composition (ratios of amylase :amylopectin, lipid, moisture, protein, and mineral content) (Liu, 2011).

Starch granules consist of approximately 25 % mostly linear α -1,4-linked amylose and 75 % α -1,4 backbone and α -1.6 branched amylopectin deposited as alternating amorphous and crystalline layers. Parallel double helices in the amylopectin align to organize the amylopectin in two different types of crystalline polymorphs: the A-type crystalline polymorph consisting of densely packed double-helical segments typical of cereal endosperm starches; and the B-type crystalline polymorph, typically found in tuberous and leaf starches, and containing a substantial amount of structured water. A third type, the C-type polymorph, is commonly found in, for example, legume seeds, and is a mixture of the A-type and the B-type polymorphs (Damager *et al.*, 2010; Pérez and Bertoft, 2010; Shaik *et al.*, 2014).

Three enzymes are important for hydrolysing grain starch to smaller molecules and eventually glucose. They are α -amylase, β -amylase, and glucoamylase. Some of these enzymes (α - and β -amylases) are naturally present in cereal grains and become active during germination. All three enzymes can also be produced and isolated from microbial or other biological sources, and then added to starch or cereal flour as exogenous sources (Liu, 2011). Accumulated end products of starch degradation might also influence enzyme activities themselves. Maltose and soluble low molecular weight dextrin's prevent the binding of reserve starch-degrading α -amylase to particulate starch. Maltose was found in expressed liquid from wheat seeds germinated for 6 days (80 mM) inhibited the activities of α - and α -amylases isolated from the same seeds by about 30 % (Kogel and Galili, 1995).

The germination process is characterized by the growth of the embryo of the grain, manifested by the rootlets growth and increase in length of the shoot (acrosipire), with the concomitant modification of the contents of the endosperm (Correia, 2013). Germination of grain commences with the uptake of water. Once germination is initiated, the predominant endosperm reserves, starch, cell wall, and storage proteins, are mobilized by the action of hydrolytic enzymes which are synthesized in the aleurone layer and in the scutellum and secreted into the starchy endosperm of germinating grains. Enzyme α -amylase plays a primary role in native starch granule degradation, and its expression is controlled by both gibberellin and sugar demand/starvation. Sugar or carbon starvation activates the α -amylase promoter (Lu *et al.*, 1998; Shaik *et al.*, 2014). As a result, during germination amylases are produced and partial breakdown of starch into simple sugars occurs (Chesworth *et al.*, 1998). Intense biochemical processes occur during the grain activation (first stage of germination), as a result grain biological value increases – the content of vitamins B2, E, and niacin, total sugar, dietary fibre and glucosamine increase; vitamin C is synthesized, and the content of essential amino acids is increased during the process of protein hydrolysis (Rakcejeva, Skudra, 2004; Rakcejeva *et al.*, 2007).

The purpose of the investigation was to evaluate starch and sugars changes in triticale grain germination processes.

MATERIALS AND METHODS

Raw Materials

Triticale grains (\times Triticosecale) variety 'Inarta' Year 2014 used in this study were obtained from State Priekuli Plant Breeding Institute, Latvia.

Grains were cleaned, washed and steeped in water at the ratio 1:2 (grains: water) for 24 ± 1 h at 22 ± 2 °C. After steeping, water was drained and steeped grains were allowed to germinate at controlled temperature (35 ± 2 °C) and $93\pm 2\%$ relative humidity (RH) in the dark (Rakcejeva, Skudra, 2004). Triticale grains were germinated for 12, 24, 36, and 48 hours and analysed immediately after germination.

Determination of Moisture Content

Determination of the moisture content was done by the sample drying at a temperature of 130 to 133 °C under precisely fixed conditions according to ICC Standard No. 110/1 (Determination..., 1976).

Determination of Falling Number

Before determination, grains were milled using a mill „PLM 3100/B” (Perten, Sweden) according AACC standard method No. 55-30.01. Falling number (FN) was determined using Hagberg-Perten standard method ISO 3093:2009 in a „Perten FN 1900” (Perten, Sweden). The method is based upon the rapid gelatinisation of a suspension of flour using a boiling water bath and the subsequent measurement of the liquefaction, by α -amylase, of the starch contained in the sample. FN values have a complex inverse relationship with the quantity of α -amylase in the sample. This relationship is known as the Perten liquefaction equation (Martinek *et al.*, 2008).

Determination of Starch Content

An Infratec™ 1241 Grain Analyzer (Foss, Sweden) was used to analyse starch content in triticale grains according to ISO 12099. The measurements are based on the fact that the main constituents in the grain such as starch and others absorb electromagnetic radiation in the near-infrared region of the spectrum. Sample preparation is not required and the measurements of starch content (% of weight basis) are directly displayed after grains are inserted in a pre-calibrated auto-analyser (Singh *et al.*, 2009).

Analyses of Starch Structure

Samples of starch were spread on a microscope slide and covered with a glass cover slip. Starch granules of grain samples were observed using triocular microscope “Leica DM 2500 LED HD” (Leica Microsystems, Germany); via 10x20 magnification of the microscope. Diameter of starch granules was measured using software “Leica Application Suite program”, according to the instructions supplied with the equipment. The equivalent diameter of an oval or tube (ellipse) was calculated (Equation 1) as follows:

$$d_e = \frac{1.55 \cdot A^{0.625}}{P^{0.25}} \quad (1)$$

where:

A – area of oval particle cross-section, m²

P – perimeter of oval particle cross-section, m.

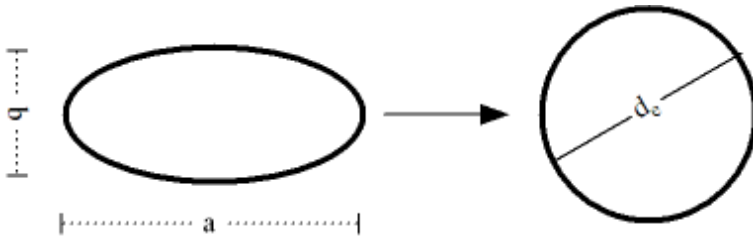

Figure 1. Dimensions of a longitudinal and spherical particles used in calculations

The cross-sectional area of an oval particle can be expressed (Equation 2) as:

$$A = \frac{\pi \cdot a \cdot b}{4}, \quad (2)$$

where:

a – major dimension of the oval cross-section of particle, m

b – minor dimension of the oval cross-section of particle, m

The perimeter of an oval (ellipse) can be approximated (Equation 3) to:

$$P \approx 2\pi \cdot \left(0.5 \cdot \left(\frac{a^2 + b^2}{4} \right) \right)^{0.5} \quad (3)$$

Determination of Individual Sugars' Content

Before the analysis 5 g of milled grain samples were extracted with 20 mL deionized water and stirred for one hour. The obtained extract was filtered through a high-performance liquid chromatography (HPLC) syringe filter with pore size of 0.45 μm. The content of

individual sugars (fructose, glucose, sucrose, and maltose) in the control (non-germinated), steeped and germinated triticale grain sample extracts was determined by high-performance liquid chromatography (Shimadzu LC 20 Prominence, Japan). Chromatographic parameters were set as follows: detector – refractive index RID-10A; column – Alltech NH₂, 4.6 mm x 250.0 mm, 5µm; temperature 25 °C; isocratic elution regime, mobile phase –A – acetonitrile,

B – deionized water (A70:B30); capacity of the injection sample – 10 µL; total time of the analysis – up to 15 min; flow rate – 1.0 mL/min. Acquired data were processed using Shimadzu LabSolutions software (LCSolution Version 1.21 SP1).

Statistical Analysis

The results (mean, standard deviation) were processed by mathematical and statistical methods. Data were subjected to one-way analysis of variance (ANOVA) by Microsoft Office Excel 2007; significance was defined at $P < 0.05$.

RESULTS AND DISCUSSION

The moisture content of experimental non-germinated (control) triticale grains was $13.27 \pm 0.30\%$ (Table 1), what mainly indicates the possibility for long storage of grain. According to *Fleurat-Lessard (2004)* and *Pieper et al. (2011)* storage of cereal grains over long period of time usually requires moisture contents below 140 g/kg (it is 14%) to prevent deterioration.

Table 1. Falling number, moisture, and starch content in triticale grains

No.	Grain sample	Falling number, s	Moisture content, %	Starch content, % in dry matter
1	Control (non-germinated)	62	13.27 ± 0.30	68.9 ± 0.8
2	Steeped	63	47.31 ± 0.09	69.4 ± 0.1
3	Germinated for 12 h	63	48.30 ± 0.22	67.1 ± 0.3
4	Germinated for 24 h	63	47.38 ± 0.34	65.0 ± 0.2
5	Germinated for 36 h	63	49.72 ± 0.11	64.3 ± 0.1
6	Germinated for 48 h	63	48.72 ± 0.12	61.0 ± 0.3

The moisture content of triticale grains after steeping was $47.31 \pm 0.09\%$ (Table 1) – what was 3.5 times higher comparing with control (non-germinated) triticale grains. Moisture content of grains during germination at controlled temperature and RH practically did not changed ($P=0.341$) compared to steeped grains and ranged from $48.30 \pm 0.22\%$ (after 12 h germination) to 48.72 ± 0.12 (after 48 h germination). It is known that steeping is a crucial

step in producing quality germinated grains. During steeping, grains uptake water and swell by approximately one third. When grains absorb water, the embryo becomes active and uses the oxygen dissolved in the steeping water for respiratory purposes. During this period under water, the dissolved oxygen in the water is rapidly adsorbed by the organic material and microflora in the grain. However, steeping conditions affect the rate of recovery from oxygen deficiency, germination rate, and onset of α -amylase production (Correia, 2013).

Starch content of analysed triticale grains was 68.9 ± 0.8 % (Table 1), what mainly conform to the study of He, 2012, who established that starch content in triticale grains range from 60.1 to 66.7 %. Cereals supply more than half of the caloric needs of the world's population, mostly in the form of starch, which comprises approximately 70 % of cereal seed weight (Awika, 2011; Tuncel and Okita, 2013). During grain steeping starch content increased till 69.4 ± 0.1 %, what was not significantly higher ($P=0.4419$) comparing with non-germinated (control) triticale grain sample. During grain germination starch content decreased by 3 % after germination for 12 h, by 6 % after germination for 24 h, and by 8 % after germination for 36 h and the most significant changes ($P=0.0040$) by 11 %, were observed after germination for 48 h comparing with control grain sample. Obtained results indicate that starch swelling process is mainly influenced by water presence and activity of α -amylase. Since triticale is known as a crop with relatively high α -amylase activity, the falling number is its significant quality indicator.

The falling number of non-germinated triticale grains was 63 s, what mainly indicate high α -amylase activity. It corresponds to the Alaru *et al.* (2003) indicating the falling number of triticale grain between 62 s and 176 s. α -amylase is an endo-acting enzyme, that inserts breaks in the interior of the very large starch molecules, small amounts of enzyme cause dramatic reductions in viscosity. However, grain having low falling number due to high α -amylase activity causes substantial economic losses to growers, significant processing and storage problems and is generally reflected in poorer quality end-products (Mares and Mrva, 2008).

The falling number decreased during grain germination till 62 s, it was not significant ($P=0.1447$) change comparing with non-germinated grains. In the present experiments insignificant ($P=0.2281$) falling number changes in grains were detected after steeping too. Obtained results mainly indicate increased enzyme activity in grains resulting in starch breakdown. Significant changes ($P=0.001$) were not observed in spherical shape diameter of B-granules during grain processing starting from steeping till germination for 48 h (Figure 2). However, in the initial stages of germination, the scutellum releases many hydrolytic enzymes that begin to degrade the cell walls of the crushed cell layer, and the walls, protein, and starch granules of the endosperm. α -amylase is absent from the hydrated aleurone, and its de-novo synthesis and release are independently triggered by the arrival of the hormone (Correia, 2013). In the present experiments changes were observed for A-starch granules disk shape during triticale grain steeping (Figure 2) and the diameter of A-granules disk shape decreased approximately twice, thus indicating starch breakdown.

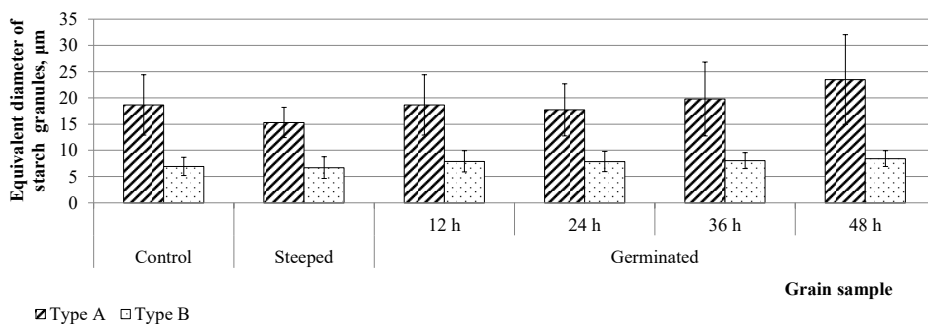

Figure 2. Changes of triticale grain starch granules' diameter during steeping and germination

In the present experiments it was obtained, that due to elevated α -amylase activity in analysed cereals occurred breakdown of A-granules during steeping (Figure 3). However, during further grain germination at controlled temperature and RH, starch granules swelled and, as a result, the diameter of A-granules disk shape increased (Figure 2 and 3). Nevertheless, there was not found significant difference ($P=0.005$) in the diameter of A-granules disk shape of grains germinated for 12–48 h. On the other hand, the swelling, gelatinization, and pasting properties of wheat starch are obviously affected by the ratio of A-and B-type granules, which can be explained by the different amylopectin chain length distributions of the A- and B-type granules (Kim and Huber, 2010; Zhang *et al.*, 2013).

Starch is synthesized in granules inside amyloplasts. Wheat, barley, rye, and triticale starches display bimodal granule size distributions: the disk-shaped, large A-granules and the spherical, small B-granules (Jane, 2003) with different physical, chemical, and functional properties (Ellis *et al.*, 1998; Zeng *et al.*, 2011). For example, the size distribution of wheat starch includes two or sometimes three size classes of granules. The larger A-granules have a lenticular shape and a diameter from 15 to 30 μm , whereas B-granules initiated at a different stage of development than A-granules, have a diameter that is typically below 10 μm and block like structures that range from polyhedral to near – spherical (Stone and Morell, 2009).

Li *et al.*, 2013 indicated that, A-granules contained a higher amount of amylose and a lower protein content and amylopectin/amylose ratio than B-granules. A-type granules exhibited a higher hydrolysis extent and swelling power than did B-granules. A-granules showed a higher peak, trough, breakdown and final viscosity, and gelatinization enthalpy than did B-granules, while B-granules exhibited a higher gelatinization temperature.

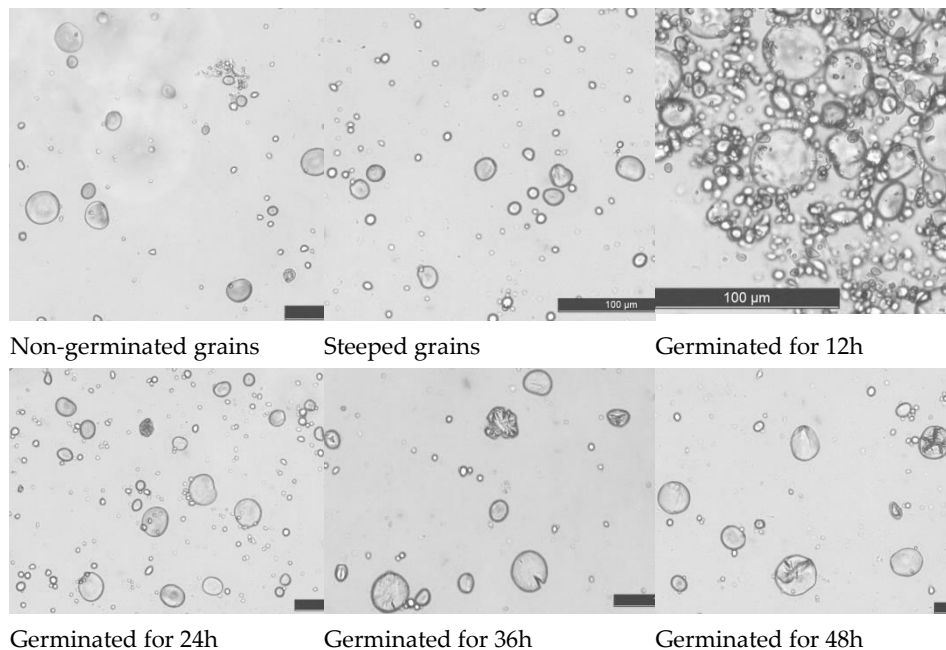

Figure 3. Light microscopy images of triticale grain starch granules

During germination the starch content decreased and the sugar content increased. About 5–6 % of starch has been broken down into sugars. For example the main sugar in malt is glucose, but fructose and sucrose are also present. There is hardly any maltose since it is immediately degraded (Preedy, 2012).

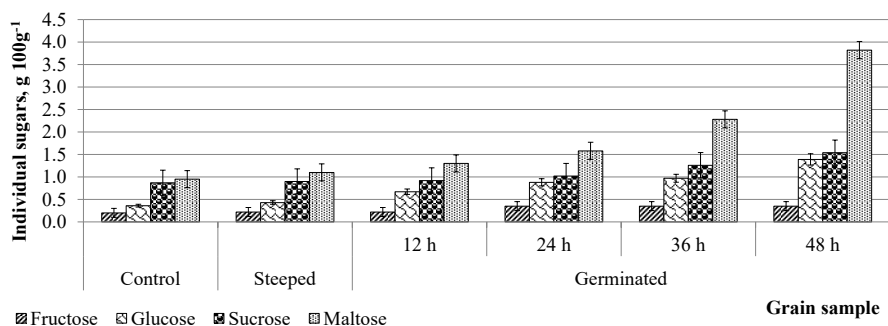

Figure 4. Individual sugars composition in triticale grains during steeping and germination

Non-significant ($P>0.05$) fructose content changes were obtained in non-germinated (control) and steeped triticale grains, within present experiments. However fructose formation was detected in triticale grains after germination for 24 h (Figure 4). Fructose content increased by 37 % ($P<0.05$) during triticale germination for 24 h and was not significantly changed ($P>0.05$) during germination for 36 h and 48 h. Obtained results mainly indicate use of fructose by cereal for further development – grow. Opposite results were obtained during analysing of glucose content in cereals during germination.

Present results demonstrate that the content of glucose increased by 16% after triticale steeping (Figure 4), mainly due to amylolytic ferment activation resulting in starch breakdown and sugar formation. Higher glucose content was observed in triticale grains germinated for 48 h – it increased by 74 % comparing with un-germinated cereal grains and by 69 % comparing with steeped grains. As a result, glucose content increased by 46 %, 59 %, and 63 % after germination for 12 h, 24 h, and 36 h respectively. However, it is necessary to indicate, that for obtaining products with lower glycemic index (GI) increased glucose content is undesirable (What is ..., 2014).

The metabolism of food derived sucrose, fruit sugars, honey, and high fructose corn syrup, major sources of fructose and glucose in the diet, are currently under study, and the biological effects resulting from the use of experimentally formulated mixtures of glucose and fructose are relevant to our understanding. The use of mixed sugars are more metabolically predictive of dietary consequences than that from single monosaccharides studied individually, as metabolism of each type of sugar is not independent from the other. Metabolic interactions between glucose and fructose significantly impact general sugar metabolism (Sun and Empie, 2013).

Minor site of sucrose synthesis in the germinated cereals is the aleurone layer. As starch hydrolysis occurs glucose is absorbed by the aleurone cells from the endosperm, converted therein to sucrose, and then released back into the endosperm. Sucrose may then be absorbed by the scutellum. The importance of this mode of sucrose formation is unknown because the relative contribution of the aleurone layer and the scutellum to the total production of sucrose for the growing embryo (Bewley and Black, 1978). Not significant sucrose content changes ($P=0.144$) was obtained for control (non-germinated), steeped and germinated for 12 h triticale grains (Figure 4). As results of our experiments demonstrate, sucrose content in triticale grains increased by 15 % after 24 h of germination, by 31 %, and by 44 % after 36 h and 48 h germination, respectively. Results of *Shaik, 2014* research demonstrate, that during barley germination and the early stage of seedling establishment up to day 3, significant differences were observed for sucrose, fructose, and ribose. However, the same study indicated, that all the sugars decreased rapidly at the late stage of seedling establishment, except fructose, ribose, and trehalose.

Present experiments revealed significant ($P<0.05$) changes in maltose content already after triticale steeping – the content of maltose increased by 14 % comparing with un-germinated grains. During grain germination, starting from 12 h the content of maltose was changed significantly. After 48 h germination obtained sugar content in triticale grains increased four times comparing with unprocessed cereals. However, in seeds, during germination, it is synthesized in a reaction catalysed by the enzyme diastase

(amylase) that hydrolyses starch to the disaccharide for the new plant. Diastase is used commercially as well to hydrolyse starch to maltose (malt) in the brewing of beer (Maltose in foods..., 2015).

CONCLUSIONS

For obtaining germinated triticale with the possibly lowest glycemic index the germination time for cereals should not exceed 24 h at controlled temperature and RH in dark. During germination for 24 h, the falling number of analysed grains was 62 s indicating elevated enzyme activity in grains, which resulted in starch changes, namely, breakdown, and therefore starch content decreased by 6%. During triticale grain steeping breakdown of A-starch granules occurred as a result of increased α -amylase activity. During triticale grain germination for 12, 24, and 48 h, at controlled conditions, starch granules swelled, as a result the diameter of A-granules disk shape increased, but the shape of B-starch granules was not changed significantly ($P>0.05$). During steeping and germination the content of fructose increased 2.0 times, glucose – 2.5 times, sucrose – 1.2 times, and maltose – 1.7 times.

ACKNOWLEDGEMENTS

The research leading to these results has received funding from the Norwegian Financial Mechanism 2009-2014 under Project Innovative approach to hull-less spring cereals and triticale use from human health perspective (NFI/R/2014/011).

REFERENCES

- Alaru, M., Laur, Ü. Jaama, E. (2003): Influence of Nitrogen and Weather Conditions on the Grain Quality of Winter Triticale, *J. Agron. Research*, 1, 3-10.
- Awika, J.M. (2011): Major Cereal Grains Production and Use around the World. In: *Advances in Cereal Science: Implications to Food Processing and Health Promotion*, Awika, J.M., Piiroinen, V., Bean, S. (ed.), American Chemical Society: Washington, DC, pp. 1-13.
- Bewley, J.D., Black, M. (1978): *Physiology and Biochemistry of Seeds in Relation to Germination and Grow*, Berlin, Germany: Springer-Verlag, pp. 188-189.
- Chesworth, J.M., Stuchbury, T., Scaife, J.R. (1998): *An Introduction to Agricultural Biochemistry*, Chapman & Hall, pp. 341-342.
- Correia, P.M. dos R. (2013): *Engineering Aspects of Cereal and Cereal-Based Products*: CRC Press, pp. 53-55.
- Damager, I., Engelsens, S.B., Blennow, A., Møller, B.L., Motawia, M.S. 2010: First Principles Insight Into the Alpha-glucan Structures of Starch: Their Synthesis, Conformation, and Hydration, *J.Chemical Reviews*, 110, pp. 2049-2080.
- Determination of the Moisture Content of Cereals and Cereal Products (Practical method). 1976. https://www.icc.or.at/standard_methods/110.1. Accessed September 3, 2015.

- Ellis, R.P., Cochrane, M.P., Dale, M.F.B., Duffus, C.M., Lynn, A., Morrison, I.M., Prentice, R.D.M., Swanston, J.S.; Tiller, S.A. (1998): Starch Production and Industrial Use, *J. Sci. Food Agric.* 77, pp. 289-311.
- Fleurat-Lessard, F. (2004): Stored Grain, Physico-Chemical Treatment. In *Encyclopaedia of Grain Science*, Wrighley, C., Corke, H., Walker, C.E. (ed.), London, UK: Elsevier Academic Press, pp. 254-263.
- Glycemic Index – Preventing Obesity, Diabetes and Heart Disease. 2006. <http://www.natural-health-information-centre.com/glycemic-index.html>. Accessed September 16, 2015.
- He, J.-F., Goyal, R., Laroche, A., Zhao, M.-L., Lu, Z.-X. (2012): Water Stress During Grain Development Affects Starch Synthesis, Composition and Physicochemical Properties in Triticale, *J. Cereal Sci.* 56(3), pp. 552-560.
- Jane, J.-L. (2003): Starch: Structure and Properties. In: *Chemical and Functional Properties of Food Saccharides*, Tomasik, P. (ed.), CRC Press.
- Kim, K.S., Huber, K.C. (2010): Supramolecular Structure of A- and B-type Granules of Wheat Starch, *J. Cereal Sci.* 51, pp. 256-264.
- King, R.A., Noakes, M., Bird, A.R., Morell, M.K., Topping D.L. (2015): An Extruded Breakfast Cereal Made From a High Amylose Barley Cultivar Has a Low Glycemic Index and Lower Plasma Insulin Response Than One Made From a Standard Barley, *J.Cereal Sci.* 48 (2), pp. 526-530.
- Kogel, J., Galili, G. (1995): *Seed Development and Germination*, New York, USA: Marcel Dekker, pp. 464-465.
- Lelley, T. (2006): *Genetic Resources, Chromosome Engineering, and Crop Improvement*: CRC Press, pp. 415.
- Li, W., Shan, Y., Xiao, X., Luo, Q., Zheng, J., Ouyang, S., Zhang, G. (2013): Physicochemical Properties of A- and B-Starch Granules Isolated from Hard Red and Soft Red Winter Wheat, *J. Agric. Food Chem.* 61 (26), 6477-6484.
- Liu, K. (2011): *Distillers Grains: Production, Properties, and Utilization*: CRC Press, pp. 59-61.
- Lu, C.A., Lim, E.K., Yu, S.M. (1998): Sugar Response Sequence in the Promoter of a Rice Alpha-Amylase Gene Serves as a Transcriptional Enhancer, *J. Biol. Chem.* 273, pp. 10120-10131.
- Maltose in Foods and Germinating Seeds. 2015. <http://www.tuscany-diet.net/carbohydrates/maltose/>. Accessed September 17, 2015.
- Mares, D., Mrva, K. (2008): Late-maturity α -amylase: Low Falling Number in Wheat in the Absence of Preharvest Sprouting, *J. Cereal Sci.* 47 (1), pp. 6-17.
- Martinek, P., Vinterová, M., Burešová, I., Vyhnánek, T. (2008): Agronomic and Quality Characteristics of Triticale (\times Triticosecale Wittmack) With HMW Glutenin Subunits 5+10, *J. Cereal Sci.* 47 (1), pp. 68-78.
- Mridula, D., Sharma, M. (2015): Development of Non-Dairy Probiotic Drink Utilizing Sprouted Cereals, Legume and Soymilk, *Lebensm.-Wiss. Technol.* 62 (1), pp. 482-487.
- Peña, R.J. (2004) Food uses of triticale. In: *Triticale improvement and production*. pp. 37-48. Available at <http://www.fao.org/3/a-y5553e/y5553e01.pdf/> Accessed October 17, 2015.
- Pérez, S., Bertoft, E. 2010: The Molecular Structures of Starch Components and Their Contribution to the Architecture of Starch Granules: a Comprehensive review, *J. Starch – Stärke.* 62, pp. 389-420.
- Pieper, R., Hackl, W., Korn, U., Zeyner, A., Souffrant, W.B., Pieper, B. (2011): Effect of Ensiling Triticale, Barley and Wheat Grains at Different Moisture Content and Addition of Lactobacillus

- plantarum (DSMZ 8866 and 8862) on Fermentation Characteristics and Nutrient Digestibility in Pigs, *J. Animal Feed Science and Technology*. 164 (1-2), pp. 96-105.
- Preedy, V.R. (2012): *Dietary Sugars. Chemistry, Analysis, Function and Effects*, Cambridge, UK: Royal Society of Chemistry, pp. 705-707.
- Rakcejeva, T., Skudra, L. (2004): Vitamin content dynamics in grain germination process. In: International Scientific Conference "Research for Rural Development 2004", Jelgava, Latvia, pp. 158-160.
- Rakcejeva, T., Skudra, L., Iljins, U. (2007): Biological Value Changes in Wheat, Rye and Hull-less Barley Grain During Biological Activation Time, *LLU Raksti* 18 (313), 25-33.
<http://llufb.llu.lv/proceedings/n18/4/llu-proceeding18-4.pdf>
- Shaik, S.S., Carciofi, M., Martens, H.J., Hebelstrup, K.H., Blennow A. (2014): Starch Bioengineering Affects Cereal Grain Germination and Seedling Establishment, *J. Exp Bot.* 65 (9), 2257–2270.
<http://www.ncbi.nlm.nih.gov/pmc/articles/PMC4036499/#CIT0037>.
- Singh, S., Mackill, D.J., Ismai, A.M. (2009): Responses of SUB1 Rice Introgression Lines to Submergence in the Field: Yield and Grain Quality, *J. Field Crops Research*. 113 (1), pp. 12-23.
- Stone, B., Morell, M.K. (2009): Carbohydrates. In: *Wheat Chemistry and Technology*, Khan, K., Shewry, P.R. (ed.), USA: AACC International, pp. 299-319.
- Sun, S.Z., Empie, M.W. (2013): Fructose Metabolism in Humans: What Isotopic Tracer Studies Tell Us. In: *Functional Foods. The Connection between Nutrition, Health, and Food Science*, Coles, L. (ed.): Apple Academic Press, pp. 111-113.
- Tuncel, A., Okita, T.W. (2013): Improving Starch Yield in Cereals by Over-Expression of ADPglucosePyrophosphorylase: Expectations and Unanticipated Outcomes, *J. Plant Sci.* 211, pp. 52-60.
- Wang, M.L., Gellar, L., Nathanson, B.-H., Pbert, L., Ma, Y., Ockene, I., Rosal, M.-C. (2015): Decrease in Glycemic Index Associated with Improved Glycemic Control among Latinos with Type 2 Diabetes, *J. of the Academy of Nutrition and Dietetics*. 15 (6). pp. 898-906.
- Watanabe, T., Berry, T.R., Willows, N.D., Bell, R.C. (2015): Assessing Intentions to Eat Low-Glycemic Index Foods by Adults with Diabetes Using a New Questionnaire Based on the Theory of Planned Behaviour, *Can. J. Diabetes*. 39 (2), pp. 94-100.
- What is the Glycemic Index? 2014. <http://nutritiondata.self.com/topics/glycemic-index>. Accessed September 16, 2015.
- Zeng, J., Li, G., Gao, H., Ru, Z. (2011): Comparison of A and B Starch Granules from Three Wheat Varieties, *J. Molecules*. 16, pp. 10570-10591.
- Zhang, B., Lia, X., Liu, J., Xie, F., Chen, L. (2013): Supramolecular Structure of A- and B-type Granules of Wheat Starch, *J. Food Hydrocolloids*. 31 (1), pp. 68-73.

MONITORING THE SEED GERMINATION BY A NON-DESTRUCTIVE NEAR INFRARED (NIR) SPECTROSCOPY METHOD

UDC 633.11 : 543.4

Mónika Bartalné-Berceli^{1*}, *Eszter Izsó*¹, *Juhász Réka*², *Szilveszter Gergely*¹,
*András Salgó*¹

¹*Budapest University of Technology and Economics, Department of Applied Biotechnology and Food Science, Szent Gellért tér 4, H-1111 Budapest, Hungary;*

**Corresponding author: berceli@mail.bme.hu*

²*Corvinus University of Budapest, Department of Canning Technology, Villányi út 29-43, H-1118 Budapest, Hungary*

ABSTRACT

The exact knowledge on the germination process of cereal and other plant seeds makes possible the estimation and planning of nutritional and food-safety properties of new raw materials with a higher physiological value. The mobilization process of germination has been compared during controlled germination of wheat and soybean seeds using a non-destructive near infrared spectroscopy method. The kinetic changes of the free/bound water ratio have been tested during the analysis of water absorption and hydration conditions. The maximum absorption of water could be observed at 1155, 1410 and 1900 nm. The kinetic of water absorption are significantly dependent on the morphology of seeds and on the variety of seeds. Intensive mobilization of carbohydrates, proteins and lipids has been demonstrated based on the measured intensities and wavelength shifts at the characteristic wavelengths. The monitored absorption maxima were at 1590 and 2270 nm in case of wheat reserved carbohydrates, while at 2070 and 2180 nm in case of soybean proteins and at 1725, 1765, 2310 and 2340 nm for lipids. With qualitative analysis of the spectra the germination process became traceable almost in real time. The NIR spectroscopy is a sufficiently sensitive technology for monitoring these biochemical and physiological processes.

Keywords: germination, NIR spectroscopy, wheat seeds, soybean seeds

INTRODUCTION

To ensure the adequate food quality is extremely important presently due to the accelerated lifestyle. In order to achieve adequate food quality the more valuable raw materials have to be used from nutritional point of view. Furthermore, it is important to apply those processing methods in which the biologically valuable properties of raw materials do not decrease. The quality and the usability of food raw materials with vegetable origin are basically determined by the physiological condition of plants. Among

the oldest cultivated plants of mankind the changes during germination of wheat and soybean has been analysed in this study.

The consumption of sprouts or sprouted seeds and the cult of germination dates back much before BC, so the valuable role of sprouts in the diet have been known for thousands of years. Germination is an important stage of plant development. The plant seed which contains all the ingredients necessary for its life starts growing in case of proper internal and external conditions. The process begins with water uptake and then the mobilization processes are started. Some of the released originally reserved nutrients provide energy, while others are built into the embryo. As the radicle and in addition the leaves capable to photosynthesize appear the germination process is finished and the vegetative stage of life begins. The natural biological processes are the series of many biochemical and enzymatic transformation or conversion. The detailed understanding of these processes has long been studied by many researchers (Bove *et al.*, 2002).

The detailed monitoring of the germination process includes the investigation of the changes of water and certain macro components. The mobilization of these components can be studied with near infrared spectroscopy. Nowadays this technique is widely used for agricultural and food testing examinations. The advantage of the NIR techniques is that it is a fast, non-destructive method which requires really small amount of materials for the measurement. Our aim (Juhász *et al.*, 2005) is to demonstrate the biochemical and physiological processes that take place during germination of wheat and soybean with the application of the properly sensitive NIR spectroscopy. Furthermore, our aim is to highlight the differences in storage mobilization between the two plants.

MATERIALS AND METHODS

Materials

The germination experiment was carried out with six different varieties of allied wheat and with three different varieties of soybean. The wheat samples were received from Martonvásár, from the Agricultural Institute, Centre for Agricultural Research, Hungarian Academy of Sciences and the germination was carried out. Table 1 summarizes the six examined wheat varieties.

The dry wheat seeds were first of all soaked in tap water for two hours. These two hours long soaking is the phase of imbibition during which the plant takes up water, whereupon the life processes are started. After these two hours the germination begins so it was considered this stage as 0 hour germination in our work. After the swelling the germination was carried out at 18-20 °C temperature, isolated from light. The sufficient amount of water for the seed germination was continuously ensured. The germination process was followed till 96 hours by taking samples in those times shown in Table 2.

The three types of soybean used in the experiments can be seen in Table 3. Soybeans also need the so called wake-up phase to start-up with the biochemical processes. Soybeans were soaked for 3-4 hours in tap water and only this point was considered as the end of imbibition and the start of germination. The germination was carried out at 21 °C continuously ensuring the sufficient amount of water. The biological process was

monitored till 56 hours and we took samples in every 8 hours. Table 4 shows the sampling times during the germination of soybean.

Table 1. The name of the wheat varieties examined in the germination experiment

1.	Bánkúti 1201	4.	Martonvásári 20
2.	Fatima 2	5.	Martonvásári 23
3.	Jubilejnaja 50	6.	GK Öthalom

Table 2. Sampling times during the germination of wheat varieties

Time of germination	Description	Time of germination	Description
dry seed	intact seed	12 hour	12 hours after imbibition
0 hour	end of imbibition	24 hour	24 hours after imbibition
4 hour	4 hours after imbibition	48 hour	48 hours after imbibition
8 hour	8 hours after imbibition	72 hour	72 hours after imbibition
		96 hour	96 hours after imbibition

Table 3. The name of the soybean varieties examined in the germination experiment

	Variety	Place of origin
1.	Kanadai	Újmohács
2.	Pannónia Kincse	Hernád
3.	Bio Pannónia Kincse	Babócsa

Table 4. Sampling times during the germination of soybean varieties

Time of germination	Description	Time of germination	Description
dry seed	intact seed	24 hour	24 hours after imbibition
0 hour	end of imbibition	32 hour	32 hours after imbibition
8 hour	8 hours after imbibition	40 hour	40 hours after imbibition
16 hour	16 hours after imbibition	48 hour	48 hours after imbibition
		56 hour	56 hours after imbibition

Methods

The near infrared spectra of wheat and soybean samples germinated for different time were taken immediately after sampling without any sample preparation (intact seed form). Two parallel measurements were made in case of wheat samples and three parallel measurements were made in case of soybean samples. The measurements were carried out in each case with a dispersive NIR device (NIRSystems 6500 monochromator system; Foss NIRSystems, Inc., Silver Spring, MD, USA) fitted with a Sample Transport Module sampling unit with a standard sample cup. Samples were scanned from 1100 nm to 2498 nm in reflectance mode with a PbS detector in 2 nm intervals.

The Microsoft® Excel 2003 program was used for data processing. Parallel measurements were averaged and then the raw spectra were plotted. The second derivative of the near-infrared spectra were created by Norris method before its evaluation (Hopkins, 2001). The Norris method also known as gap-segment method was carried out with multiple settings but finally the commonly used one data-point gap and five data-point segment settings have been chosen. The derivation promotes the improvement of the signal-to-noise ratio, the separation of overlapping peaks and the elimination of baseline shift arising from the physical properties. Since the derivation is a linear mathematical operation so the Lambert-Beer law can be used equally well in the derivative spectra for quantification.

RESULTS AND DISCUSSION

Raw and second derivate NIR spectra of the germinated wheat and soybean samples

Typical changes can be observed during the germination processes of plants. These changes can be well followed on the near infrared spectra of the samples. The characteristics occurring during the progression of germination were the same in case of the different wheat varieties and in case of the different soybean varieties. One wheat variety (GK Öthalom) and one soybean variety (Kanadai) have been chosen in order to get an easy overview. The changes of characteristics observed at each components are shown only on the examples of these 1-1 variety. The largest, most obvious change during the biological process is the high water absorption of the seeds what is well traceable on the raw spectra as well (Fig. 1 and Fig. 2).

In the literature, three water absorption bands having the largest intensity are observed each of them are in the 1100-2500 nm near infrared range (Gergely and Salgó, 2003). The absorption maxima of the three bands varies slightly for example as an effect of the temperature, in our case they are around 1900, 1410 and 1160 nm. The three water peaks show similar changes in case of the wheat and soybean samples. In both cases the biggest changes can be observed between the dry sample and the soaked sample (end of imbibition) as the water absorption causes an increase in absorbance. The raw spectra are sensitive to the physical properties geometry of the grains and their volume caused baseline shifts.

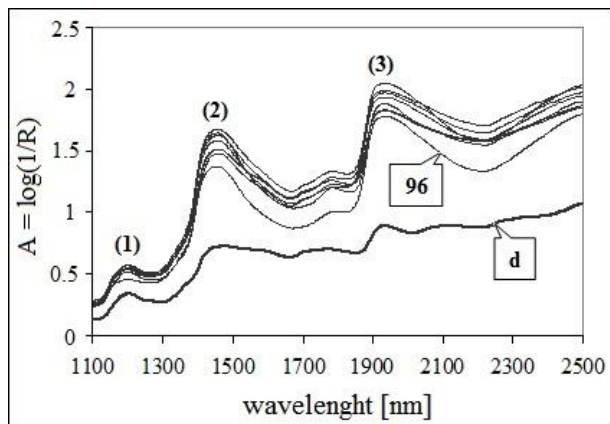

Figure 1. Changes of the raw NIR spectra of wheat samples during germination in variety GK Öthalom (d – dry seed; 96 – seed germinated till 96 hours; (1) – Water peak I. (1160nm); (2) – Water peak II. (1410nm); (3) – Water peak III. (1900nm))

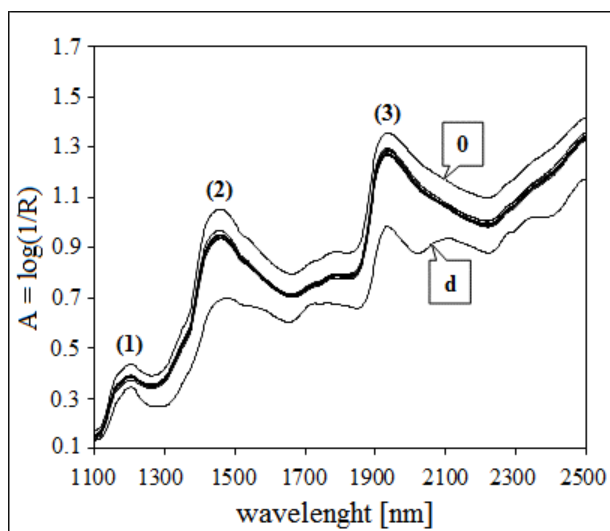

Figure 2. Changes of the raw NIR spectra of soybean samples during germination in variety Kanadai (d – dry seed; 96 – seed germinated till 96 hours; (1) – Water peak I. (1160nm); (2) – Water peak II. (1410nm); (3) – Water peak III. (1900nm))

The baseline shifts can almost completely be eliminated, the overlapping peaks can be separated so well-defined absorption bands can appear by the formation of second derivatives. The mathematical transformation was carried out both for the raw spectra of

wheat and of soybean samples (Fig. 3 and Fig. 4). The peaks appear as the local minimum have to be considered in the formed second derivate spectra.

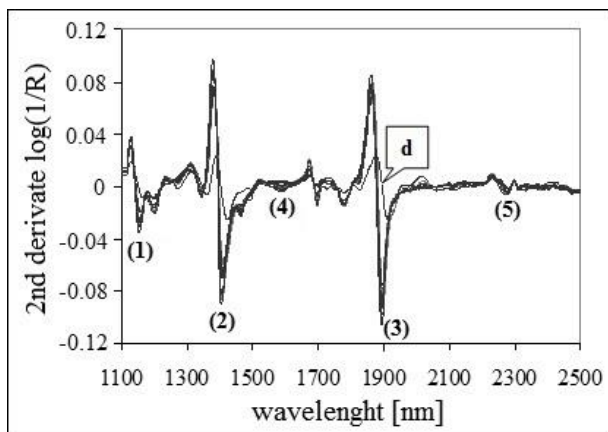

Figure 3. Changes of the second derivate NIR spectra of wheat samples during germination in variety GK Öthalom (d – dry seed; (1) – Water peak I. (1160nm); (2) – Water peak II. (1410nm); (3) – Water peak III. (1900nm); (4) – Carbohydrate peak I. (1590nm); (5) – Carbohydrate peak II. (2280nm))

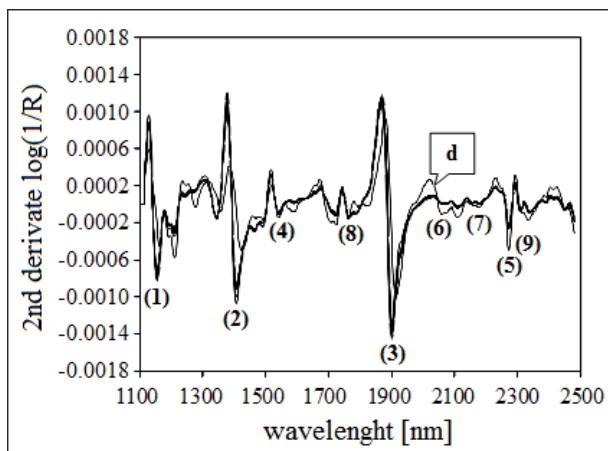

Figure 4. Changes of the second derivate NIR spectra of soybean samples during germination in variety Kanadai (d – dry seed; (1) – Water peak I. (1160nm); (2) – Water peak II. (1410nm); (3) – Water peak III. (1900nm); (4) – Carbohydrate peak I. (1590nm); (5) – Carbohydrate peak II. (2280nm); (6) – Protein peak I. (2060nm); (7) – Protein peak II. (2180nm); (8) – Lipid peak I. (1765nm); (9) – Lipid peak II. (2310nm))

The three water peaks appear with the highest intensity even on the second derivate spectra of the germinated wheat samples as it was observed also on the raw spectra. However, the peaks become sharper and also new typical peaks appeared on the derivate spectra. Wheat grain is very rich in starch, its starch content is almost 72 % referred to dry matter. Furthermore, it contains cell wall forming polysaccharides in smaller ratio and also water soluble carbohydrates (Lásztity, 1999). It is difficult to interpret most of the absorption bands associated to carbohydrates because proteins or the protein-starch interactions also have absorption at the specific wavelength (Wesley *et al.*, 1998). On the second derivate spectra of the germinated wheat samples two peaks typical for carbohydrates could be identified. The absorption band appears around 1590 nm it is attributed to the hydroxyl groups being involved in the hydrogen bonds of the starch so the peak may be suitable for the monitoring of the changes occurring in the structure of the starch. The other absorption band appears around 2280 nm. It is attributed to the water soluble carbohydrates (Gergely and Salgó, 2005).

Concerning the absorption bands of water the same can be mentioned about the second derivate spectra of the germinated soybean samples as about the second derivate spectra of wheat samples. This means that three, sharply separated water peak can also be easily identified here as well. The water peaks of soybean have a higher intensity than the wheat samples, its reason probably is that a greater swelling is occurring during soybean germination. This means the water absorption is greater and faster in case of the germination of soybean than in the case of the germination of wheat. The chemical composition of soybeans differs significantly from wheat. The bulk of the soybean is protein. It contains also significant amounts of lipid (approx. 20%). Its carbohydrate content is much below 10 % whereof starch is very few, water-soluble carbohydrate and fibre is relatively more. The carbohydrates were also characterized with the negative peaks appear also in case of soybean around 1590 and 2280 nm. It is possible to measure the proteins with near infrared technique due to the absorption bands obtained from the vibration of protein framework and the vibration derived from the protein side chains. The absorption band known from the literature, identified as the lowest wavelength is at 2060 nm. This peak and the one at 2180 nm which is widely used to the determination of the protein content were analysed during our germination process. Lipids appear in the form of typical double peaks in the near infrared spectrum. The molecule can be identified with the vibration of CH, CH₂ bonds. The double lipid peaks observed around 1725-1765 nm and 2310-2340 nm were analysed. Proteins also indicates absorption in the 1725 and 2340 nm wavelength range so these ranges have not been further analysed. The changes of the lipid components in the germinated soybean seeds can however be successfully monitored at 1765 and 2310 nm (Salgó and Gergely, 2012).

Changes in the moisture content of wheat and soybean samples during germination

The magnitude of the absorbance of the peaks is proportional to the concentration of the component. Thus the changes of the peak magnitude are reflecting the changes of the concentration of the component as the germination process progresses. For presenting the quantitative changes the second derivative spectra were used. The inverse of the local

minimum of the negative peaks appears at the specific wavelength they are depicted as a function of the time elapsed from the beginning of imbibition. At first three absorption bands of water mentioned earlier are examined in more details. The changes of the inverse of the local minimum of the three typical peaks are demonstrated in Fig. 5 in case of wheat and in Fig. 6 in case of soybean samples.

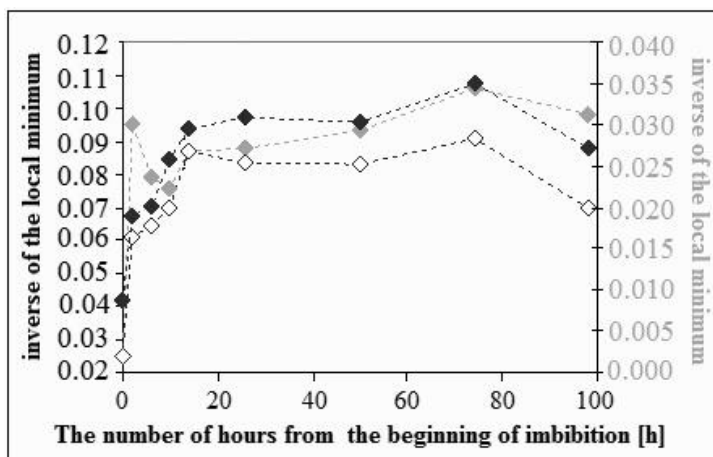

Figure 5. Changes in the absorption value of water peaks during the germination of wheat (GK Öthalom) (◊ – Water peak I. (1160 nm); ◊ – Water peak II. (1410 nm); ◆ – Water peak III. (1900 nm))

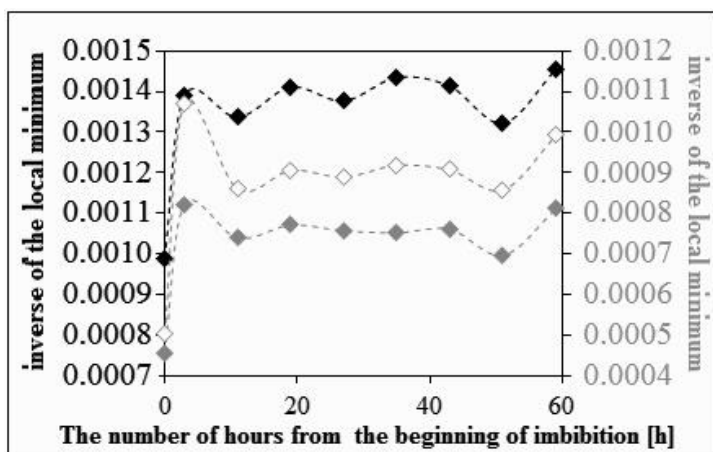

Figure 6. Changes in the absorption value of water peaks during the germination of soybean (Kanadai) (◊ – Water peak I. (1160 nm); ◊ – Water peak II. (1410 nm); ◆ – Water peak III. (1900 nm))

The germination process can start only with water absorption. Due to water absorption the intact seed begins to swell and its metabolic processes are activated. The large-scale, rapid water uptake occurring at the beginning of wheat germination can be easily followed in Fig. 5. Significant, two-three-fold increase in the amount of water compared to the initial status can be observed already after a few hours of imbibition in all of the three water peaks. The biggest changes can be observed at the absorption values of the peak of water appearing at 1160 nm. The changes of the absorption value of the three water peaks are similar hereinafter during the process. The extent of the water absorption slows down, but further low water absorption can be observed with the continuation of the germination process. The seeds are metabolically active during this period but they take up only a little water. The decrease of the water content of the germinated wheat seed can be observed between the 72 and 96 hours after imbibition. The radicle and the stem have appeared by this time and therefore probably the germination process is completed.

At the beginning of soybean germination (Fig. 6) also the large-scale water uptake starts the biological process. According to the NIR spectra the absorption of the three water peaks are also significantly increased at the end of imbibition. The characteristic of the changes of the three typical absorption bands are also very similar in case of soybean, too. Thereafter under the reviewed period a slight increase in the amount of water can be observed apart from the observed decline at 8 and 48 hours germination.

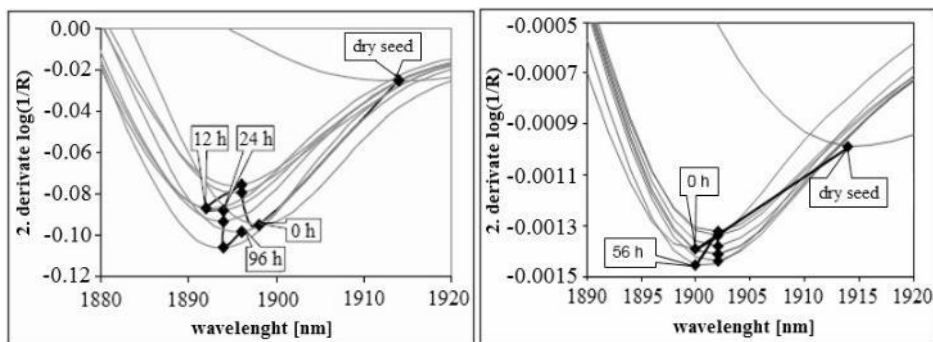

Figure 7. Changes of Water peak III. during germination (A: wheat, B: soybean)

Fig. 7 shows the combination absorption band called as Water peak III. which appears around 1900 nm. The changes in the second derivate spectra occurring during germination can be seen in case of wheat in Fig. 7A and in case of soybean in Fig. 7B. While the magnitude of the negative peak is proportional to the concentration of water, until then the wavelength shift refers to the changes of water status.

Changes occurring during germination can be well monitored in Fig. 7, wherein the local minimum of the second derivate $\log(1/R)$ values on the segment of the spectrum of Water

peak III. was following the biological process connected. The location of the local minimum of the water peaks is shifted significantly during imbibition in the direction of lower wavelengths i.e. to higher energy ranges. This phenomenon indicates that the amount of “free water” is growing. The location of the local minimum of the water peaks changes only slightly in the period after imbibition and the change does not show a definite tendency, so the change in the ratio of “free water” to “bound water” is no longer remarkable. By examining the wavelength shifts of Water I. and Water II. peaks basically the same has been observed, so we disregard their demonstration.

Changes in the macro component content of wheat and soybean samples during germination

The monitoring of the changes in the macro component content were carried out as it was presented by the changes of water content. So the inverse of the local minimum of the negative peaks at the specific wavelength were plotted as a function of the numbers of hours from the beginning of imbibition. The changes of the two identified carbohydrate peaks could be analysed in case of wheat and soybean as well. In case of wheat Fig. 8, in case of soybean Fig. 9 shows the changes during the germination process. The protein and lipid peaks could be identified only in the spectra of soybean samples as these components are present in wheat in a relative small amount. The changes of proteins can be followed in Fig. 10 while the changes of lipids in Fig. 11.

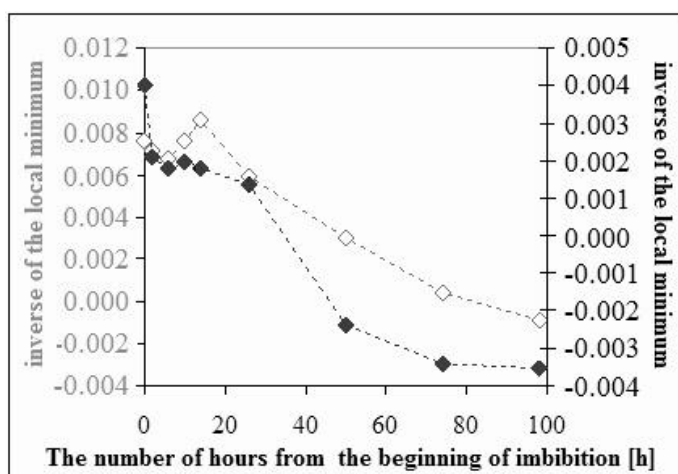

Figure 8. Changes of the absorption values of the carbohydrate peaks during wheat (variety: GK Öthalom) germination (◆ – Carbohydrate peak I. (1590nm); ◇ – Carbohydrate peak II. (2280nm))

The change between the dry seed and the seed germinated for 0 hour, namely during imbibition there is only a relative change. A high rate reduction can be observed in case of

all macro components during imbibition. Due to the significant amount of water absorption the amount of all other components is relatively reduced (dilution of components). During germination the reserved nutrients are degraded and since the main mass of the wheat seed is carbohydrate therefore the reduction in the amount of carbohydrates is spectacular during the biological process as it can be observed in Fig.8. Between 24 and 72 hours after imbibition is the decrease the most significant (loss of starch).

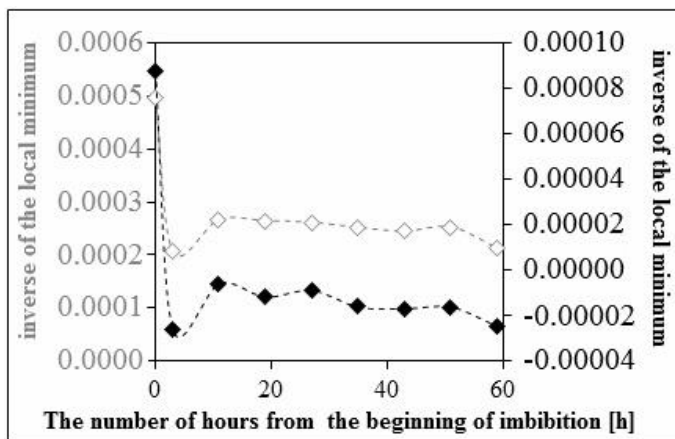

Figure 9. Changes of the absorption values of the carbohydrate peaks during soybean (variety: Kanadai) germination (◆ – Carbohydrate peak I. (1590 nm); ◇ – Carbohydrate peak II. (2280 nm))

Fig. 9 shows the changes of the absorption values of the two carbohydrate peaks examined during the germination of soybean. In case of soybean the relative decrease in the carbohydrate content during imbibition can also be observed. It is well known that the carbohydrate content is very low, about one tenth of that of wheat in percent. Within carbohydrates the starch content is extremely low and the water soluble carbohydrates were dissolved during imbibition. Thus only a slight decrease was observed during the germination process in the carbohydrate content.

The characteristic changes in the protein content of soybean germination are demonstrated in Fig.10. The high rate decrease in the protein amount during during imbibition is also only relative and is a result of dilution. Further progressive reduction can be observed in the protein content after imbibition due to the mobilization of the reserved nutrients. The reduction is not very significant probably because of the next two reasons. On one hand primarily the subunit structure of the proteins is changing during germination. On the other hand the synthesis of the proteins including the enzyme proteins begins

relatively early stage of the germination process somewhat compensating the protein degradation.

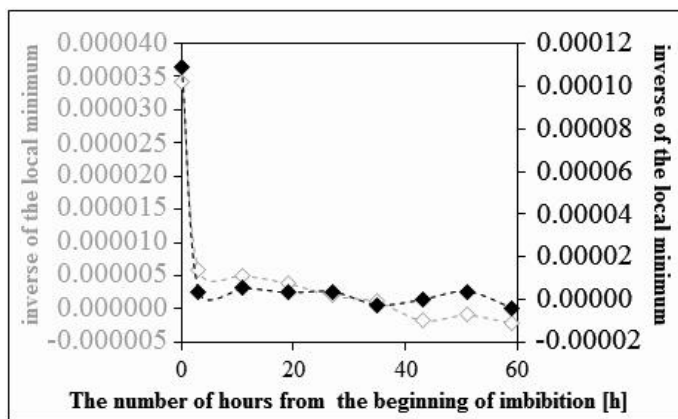

Figure 10. Changes of the absorption values of the protein peaks during soybean (variety: Kanadai) germination (◆ – Protein peak I. (2060 nm); ◇ – Protein peak II. (2180 nm))

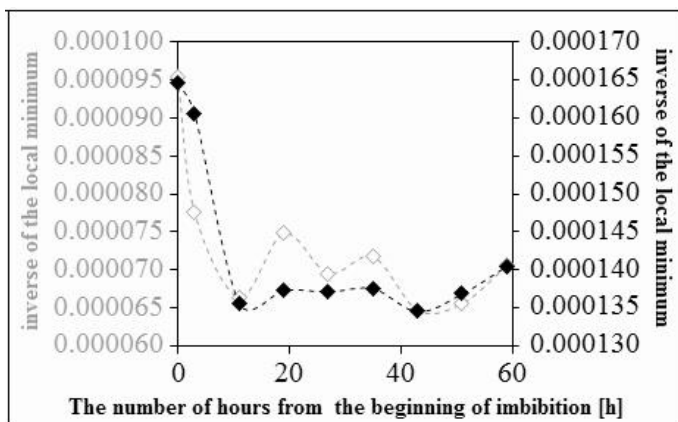

Figure 11. Changes of the absorption values of the lipid peaks during soybean (variety: Kanadai) germination (◆ – Lipid peak I. (1765 nm); ◇ – Lipid peak II. (2310 nm))

The amount of lipids during germination can be examined by the help of Fig. 11. The earlier observed relative reduction can also be experienced in the lipid content of soybean during imbibition. The lipid content however have been decreased significantly till the 8th

hour after imbibition. Interpretation of subsequent changes require further investigations. Hence we are planning to examine the samples after drying them.

CONCLUSIONS

Nutritionally valuable food raw materials can be produced with the use of new, more accurate knowledge of the germination process of plant seeds. Wheat and soybean seeds were germinated under controlled conditions and the biological process was monitored with near infrared spectroscopy method. The amount and status ("free" or "bound water") of water changes a lot during germination these can easily be followed with the analyses of NIR spectra. The three typical absorption bands of water were observed with each samples, their characteristic changes were very similar. Among macro components the changes of the carbohydrate content was well traceable in case of the samples of both plants. The observed differences are due to the compositional difference between wheat and soybean. In case of proteins and lipids the absorption maximum can be identified and monitored only in the spectra of soybean samples. The changes of each components are in accordance with the physiological processes except those of lipids. NIR spectroscopy enable us to monitor the biochemical and physiological processes of germination almost in real time.

This non-destructive and properly sensitive technology offers many new application opportunities. It is well known that the harmful phenomenon of sprouting in ear causes so many problems for farmers. With the early detection of the beginning of the germination process the economic loss can greatly be reduced. The benefits of this near infrared technology can also be utilized during malting and in the brewing industry. With the germination of legumes such as soybean the nutritional value of the seeds can be increased since the valuable substances become more accessible and the substances harmful for the human body are partially or fully degraded during the process. The presented experimental work offers still many application and development opportunities.

ACKNOWLEDGEMENTS

The research leading to these results has received funding from the European Union Seventh Framework Programme FP7/2007- 2013 under grant agreement n° 266331.

REFERENCES

- Bove J., Jullien M., Grappin P. (2002): Functional genomics in the study of seed germination. *Genome Biol.* 3(1): reviews1002.1–1002.5. Epub 2001 Dec 21. Print ISSN 1465-6906; Online ISSN 1465-6914
- Gergely Sz. and Salgó A. (2003): Changes in moisture content during wheat maturation – what is measured by NIR spectroscopy? *Journal of Near Infrared Spectroscopy*, 11(1), 17-26.
<http://dx.doi.org/10.1255/jnirs.350>

Gergely Sz. and Salgó A. (2005): Changes in carbohydrates content during wheat maturation – what is measured by NIR spectroscopy? *Journal of Near Infrared Spectroscopy*, 13(1), 9-17.
<http://dx.doi.org/10.1255/jnirs.452>

Hopkins D.W. (2001): What is a Norris derivative?, *NIR news* (12) 3-5.

Juhász R., Gergely Sz., Gelencsér T., Salgó A. (2005): Relationship between NIR spectra and RVA parameters during wheat germination. *Cereal Chemistry*, 82 (5) 488-493.
<http://dx.doi.org/10.1094/CC-82-0488>

Lásztity R. (1999): General characterization of the chemical composition of cereal grains. In *Cereal chemistry*. Budapest, Hungary: Akadémiai kiadó, pp. 13-52. ISBN: 9630576260

Salgó A. and Gergely Sz. (2012): Analysis of wheat grain development using NIR spectroscopy. *Journal of Cereal Science*, 56, 31-38. doi: 10.1016/j.jcs.2012.04.011.

Wesley I. J., Larsen N., Osborne B. G., Skerritt J. H. (1998): Non-invasive monitoring of dough mixing by near infrared spectroscopy. *J. Cereal Sci.* 27(1), 61-69. DOI:10.1006/jcrs.1997.0151

MONITORING OF HEAT-TREATED WHEAT MILLING FRACTIONS BY NEAR- INFRARED SPECTROSCOPIC METHOD

UDC 664.715 : 543.4

Eszter Izsó, Mónika Bartalné-Berceli, András Salgó, Szilveszter Gergely*

Budapest University of Technology and Economics; Department of Applied Biotechnology and Food Science; Szent Gellért tér 4., H-1111 Budapest, Hungary

**Corresponding author: izso@mail.bme.hu*

ABSTRACT

The aims of this study is to elaborate near-infrared spectroscopic method for testing and recognition of heat-treatment effects in the case of the wheat milling fractions and quality changes of the fractions. These wheat products and fractions were produced under industrial conditions by Gyermely Corp. flour-mill, Hungary and the heat-treatments were executed by Bühler AG, Switzerland. Standard Hungarian wheat flour (WF), Hungarian cake flour (CF) and aleurone-rich wheat flour (ARF) were examined. The samples were separated according to heat treatments, which involved hydrothermal and dry-thermal treated samples and untreated samples, respectively. The changes of the main chemical components (such as starch, protein) according to the heat treatments analyzed by dispersive spectrophotometer using visible (VIS) and near-infrared (NIR) regions of the electromagnetic radiation. Close correlations were obtained between the data of spectroscopic measurement techniques processed by various chemometric methods (e.g. principal component analysis [PCA], cluster analysis [CA]) and the types of treatments. Not only the differences caused by the milling technology and the heat treatment settings, but also the differences between the dry-thermal and the hydrothermal treating were clearly observed. The NIR method was able to detect the deviation of the fractions in the case of the same heat treatment parameters, too.

Keywords: wheat fractions, heat treatment, near-infrared spectroscopy, multivariate data analysis.

INTRODUCTION

Wheat is one of the most important cereal from the aspect of human nutrition, because the grain crops are containing 60-70% carbohydrate, they are easy to store and process and they have wide range of use (Chang, 2003; Lásztity, 1999). The average composition of a wheat grain is 71.9%, 12.2%, 1.9%, 1.7% of starch, protein, non-starchy carbohydrate and ash, respectively (Lásztity, 1999). Between the common wheat (*Triticum aestivum*) can make a distinction according to different types of milling products such as the standard Hungarian wheat flour (WF) and the Hungarian cake flour (CF), respectively.

The "Pannon Wheat", which is constituted the samples during our study, is a certification mark (i.e. one that gives legal assurance regarding the quality or other characteristics of

certain products) that certifies the homogeneity and the excellent baking characteristics of the product and gives warranty that it has been produced under controlled conditions (Centre for Agricultural Research – Hungarian Academy of Sciences, 2011). The main parameters of the wheat, which are measurable by near-infrared spectrophotometers are moisture, protein, starch, wet gluten, ash content and some rheological parameters (Miralbés, 2003). On-line NIR devices allow the detection and improvement of grain and cereal product quality indifferent processed products (i.e. grain, flour, bread, extrudates etc.) (Evans *et al.*, 1999; Pojić *et al.*, 2012; Vigni *et al.*, 2009).

To realize physical and rheological modifications or longer shelf-life of wheat flour the heat treatment methods could be applied. Two kinds of basic heat treatment processes are existed, dry and hydrothermal processes can be distinguished based on the presence or absence of moisture (Lehtinen *et al.*, 2003). The dry heat treatment causes significant changes in the physico-chemical properties of the starch, without destroying its granule structure (Chiu *et al.*, 1998; Chung *et al.*, 2007). In spite of this the hydrothermal heat treatment have been employed since a long time for food preparations as well as chemical and structural modifications leading to the generation of desired coloured and flavoured compounds (Friedman, 1996).

There are several reports which is examining flour mixtures, but these prefer to observe one kind of bakery products or raw materials. In contrast the main aim in our study is to monitor different fractions of wheat flour, which were carried out simultaneously to highlight the variability of the different kinds of products according to the different types of heat treatments effect.

MATERIALS AND METHODS

Samples

The “Pannon wheat” origin milling fractions were produced by Gyermelyi Corp. flour-mill (Gyermely, Hungary). Three kinds of milling products were examined, the Hungarian cake flour (CF) with low baking quality and the standard Hungarian wheat flour (WF), which is commercially available bread flour and an aleurone-rich wheat flour (ARF) which is a newly-developed experimental wheat flour, was also produced and developed at Gyermelyi Corp., Hungary with the cooperation of the Department of Applied Biotechnology and Food Science, Budapest University of Technology and Economics, Hungary and Bühler AG, Switzerland (Bagdi *et al.*, 2014). The composition of the samples are contained in Table 1. During the measurements the samples were examined according to two kinds of aspects, one of was the dry-thermal treatment and another was the hydrothermal treatment. The heat treatments of the flours were carried out in the laboratory of Bühler AG, Switzerland. First of all during the dry-thermal treatment (Dth) the samples were heated up with the thermo pneumatics and then they were hold at 100 °C for 12 min. During the hydrothermal process, the flours were heated up with steam in the conditioner and then they were dried with the thermo pneumatics. At the end of the processes the moisture content of the products were adjusted to 5% at dry treatment and 10% at hydrothermal treatment. The parameters of the treatments are

listed in the Table 2.

Table 1. Compositions of the examined wheat flours (Bagdi, 2014; Bucsellà, 2016)

Composition	Hungarian wheat flour (WF) [% dry weight basis]	Hungarian cake flour (CF) [% dry weight basis]	Aleurone-rich wheat flour (ARF) [g/100g]
Ash	1.7	0.67	3.83
Protein	12.2	11.4	26.67
Starch	71.9	69.4	47.65
Total Dietary Fibre	1.9	4.1	17.59
Crude Fat	1.9	1.5	4.26

Table 2. Parameters of applied methods in the case of different types of thermal treatments (CF = cake flour, WF = wheat flour, ARF = aleurone-rich wheat flour)

Types of milling product	Abbreviation	Steam moisture [L/h]	Retention time [min]	Temperature of product [°C]
Untreated CF	CF	-	-	-
Untreated WF	WF	-	-	-
Untreated ARF	ARF	-	-	-
Dry-thermal treated WF	Dth WF	0.00	12.00	102.00
Dry-thermal treated WF	Dth WF	0.00	12.00	90.00
Dry-thermal treated WF	Dth WF	0.00	6.00	90.00
Dry-thermal treated WF	Dth WF	0.00	12.00	101.00
Dry-thermal treated CF	Dth CF	0.00	15.00	107.00
Dry-thermal treated CF	Dth CF	0.00	8.00	106.00
Dry-thermal treated CF	Dth CF	0.00	12.00	101.00
Hydrothermal-treated WF	Hyd WF	5.00	5.00	96.00
Hydrothermal-treated CF	Hyd CF	5.00	5.00	96.00
Hydrothermal-treated WF	Hyd WF	10.00	5.00	96.00
Hydrothermal-treated CF	Hyd CF	10.00	5.00	95.00
Hydrothermal-treated WF	Hyd WF	20.00	5.00	95.00
Hydrothermal-treated CF	Hyd CF	20.00	5.00	96.00
Dry-thermal treated ARF	Dth ARF	0.00	12.00	101.00
Hydrothermal-treated ARF	Hyd ARF	5.00	5.00	96.00
Hydrothermal-treated ARF	Hyd ARF	10.00	5.00	96.00
Hydrothermal-treated ARF	Hyd ARF	20.00	5.00	96.00

Reference materials

The reference materials for spectroscopic measurements were gluten from wheat and unmodified wheat starch from Sigma Chemical Co. (St Louis, MO, USA).

Spectroscopic measurements

Samples were scanned using dispersive NIR instrument (NIRSystems 6500 monochromator system; Foss NIRSystems, Inc., Silver Spring, MD, USA) fitted with a Rapid Content Analyser (RCA) and micro-sample cup equipped with threaded back to collecting the raw spectra. Samples were scanned from 400 nm to 2498 nm in reflectance mode (R mode: Si detector [400-1098 nm] and PbS detector [1100-2498 nm]). Spectral and reference data were processed using Vision 3.20 (Foss NIRSystems, Inc., Silver Spring, MD, USA), Microsoft Excel 2013 (Microsoft Corporation, Redmond, WA, USA), Statistica 12 (StatSoft, Inc., Tulsa, OK, USA) software packages. The first and second order derivatives (D1OD and D2OD, respectively) were calculated from the raw spectra by gap-segment method. Raw VIS-NIR spectra were transformed into D2OD using 2/0 nm, 4/0 nm, 8/0 nm, 12/0 nm, 16/0 nm and 20/0 nm segment and gap size, respectively by Vision 3.20 software. The D2OD 8/0 nm gap-segment setting was applied in the case of each spectra and used multivariate data analysis such as principal component analysis (PCA) and cluster analysis (CA). The PCA is a projection method that provides an interpretable overview of the main information contained in a multidimensional table. It takes the information carried by the original variables and projects them onto a smaller number of latent variables called principal components (PC) (Martens and Naes, 1991; Wold *et al.*, 1987). By plotting PCs important sample and variable interrelationships can be revealed, leading to the interpretation of certain sample groupings, similarities or differences. The CA is an exploratory data analysis tool, the main aim of which is to sort the different objects into groups. CA observes the degree of association between objects and it is maximum if they belong to the same group and minimum the other way round (Heise and Winzen, 2002).

RESULTS AND DISCUSSION

The deviations of the three untreated fractions (i.e. Hungarian cake flour [CF], standard Hungarian wheat flour [WF] and aleurone-rich wheat flour [ARF]) had already been appeared in the case of the raw spectra in the visible (VIS) and near-infrared (NIR) ranges too (data not shown). Based on the raw spectra there were no significant differences between the untreated and the dry-thermal heated samples (Dth samples), however there were huge baseline shift in the spectra of the hydrothermal-treated samples (Hyd samples) in the range of NIR (1100-2498 nm). Between the ARF fraction and CF and/or WF populations appropriate separations were observed. Firstly, the ARF fraction (Dth ARF, Hyd ARF) has a higher aleurone-content, than the CF and the WF fractions and these physical and chemical properties caused the deviations between the fractions in the VIS range (Fig. 1).

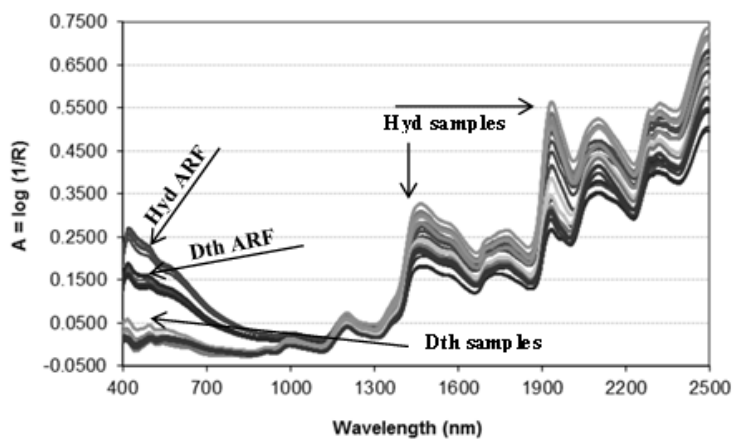

Figure 1. Raw VIS-NIR spectra in the case of untreated, dry-thermal treated (Dth) and hydrothermal-treated (Hyd) samples (ARF = aleurone-rich wheat flour).

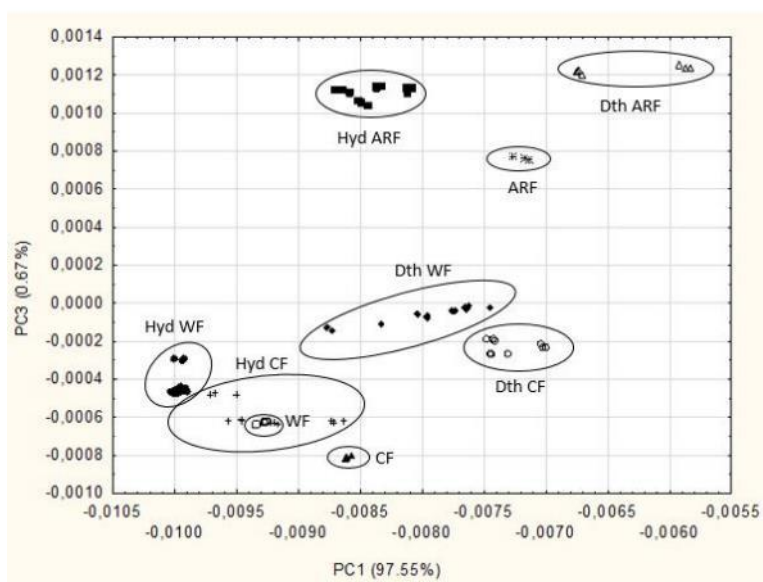

Figure 2. PCA score plot in the case of the untreated (▲: CF; □: WF; #: ARF), dry-thermal treated (◆: Dth WF; ○: Dth CF; △: Dth ARF) and hydrothermal-treated (●: Hyd WF; +: Hyd CF; ■: Hyd ARF) samples based on D2OD 8/0 nm spectra (CF = cake flour, WF = wheat flour, ARF = aleurone-rich wheat flour).

The applied PCA method in the range of 1100-2498 nm highlighted the differences according to the heat treatments in the case of all fractions as shown in the Fig. 2. The score values of first principal component (PC 1) and the third principal component (PC 3) showed main deviations between the ARF fraction and the rest of the fractions due to the diverse chemical properties (Table 1). Besides of these detectable changes due to the different types of heat treatments too. The differences of the treatments were detected by based on the PC 1 and the deviations of the fractions were evaluated according to the PC 3. The ARF fraction separated well according to the heat treatments (untreated, dry-thermal treated and hydrothermal-treated), whereas between the CF and the WF fractions differences appeared in the case of dry-thermal treated samples. The hydrothermal-treated and untreated samples in the case of this two fractions the PCA score plot did not show significant deviations.

Second order derivative (D2OD) with 8/0 nm gap-segment setting was used to retain the sensitivity and get more informative peaks about the milling fractions. The D2OD 8/0 nm spectra of the reference materials and the D2OD 8/0 nm spectra of the samples had high variability of main components, which are detectable (data not shown).

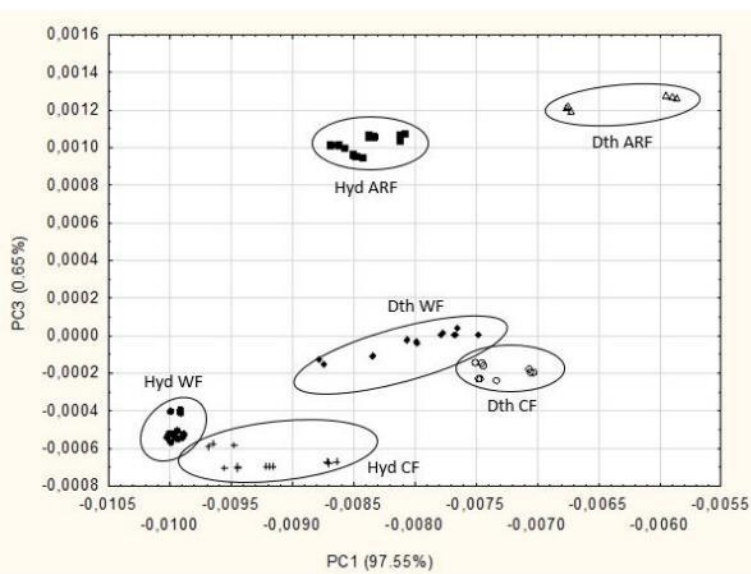

Figure 3. PCA score plot in the case of the dry-thermal treated (\blacklozenge : Dth WF; \circ : Dth CF; Δ : Dth ARF) and hydrothermal-treated (\bullet : Hyd WF; $+$: Hyd CF; \blacksquare : Hyd ARF) samples based on D2OD 8/0 nm spectra (CF = cake flour, WF = wheat flour, ARF = aleurone-rich wheat flour)

The impact of different heat treatments on samples could be observed more expressed on PCA score plot made by excluding the untreated samples focusing on variations of NIR spectra of treated samples (Fig. 3). The separations of the WF and the CF fractions were showed up by the score values of PC 1 and PC 3, next to the ARF fraction. There were mainly separations according to the PC 1 in the case of the settings of the treatments, while the distinction of the type of the fractions were observed based on the PC 3. In the case of all samples changes caused by the different treatments could be monitoring by the NIR spectroscopic method, so this non-destructive method was able to detect the deviations between the samples even if there was no main difference in the composition of the fractions (i.e. Hungarian cake flour [CF] vs. standard Hungarian wheat flour [WF]) in the case of the same dry-thermal and hydrothermal treatments settings.

Table 3. Correlation values (r) between the first three loadings of PCA and the D2OD 8/0 nm NIR spectra of reference materials in the case of hydrothermal-treated samples (PC = principal component)

Pearson r	Protein	Starch	PC 1	PC 2	PC 3
Protein	1.000	0.539	-0.676	-0.068	0.549
Starch	0.539	1.000	-0.977	-0.023	-0.182
PC 1	-0.676	-0.977	1.000	0.000	0.000
PC 2	-0.068	-0.023	0.000	1.000	0.000
PC 3	0.549	-0.182	0.000	0.000	1.000

Table 4. Correlation values (r) between the first three loadings of PCA and the D2OD 8/0 nm NIR spectra of reference materials in the case of dry-thermal treated samples (PC = principal component)

Pearson r	Protein	Starch	PC 1	PC 2	PC 3
Protein	1.000	0.538	-0.667	0.089	0.583
Starch	0.538	1.000	-0.969	0.142	-0.171
PC 1	-0.667	-0.969	1.000	-0.000	-0.000
PC 2	0.089	0.142	-0.000	1.000	0.000
PC 3	0.583	-0.171	-0.000	0.000	1.000

The Pearson correlation values (r) were calculated between the first three loadings of PCA and the D2OD 8/0 nm NIR spectra of reference materials in the case of the dry-thermal and hydrothermal treatments, respectively. The starch correlated with the loadings of PC 1 of hydrothermal-treated samples ($r = 0.977$) and the loadings of PC 3 with protein ($r =$

0.549), respectively (Table 3). In the case of the dry-thermal treated samples the loadings of PC 1 was highly ($r = 0.969$) correlated with starch and the loadings of PC 3 with protein ($r=0.583$) (Table 4).

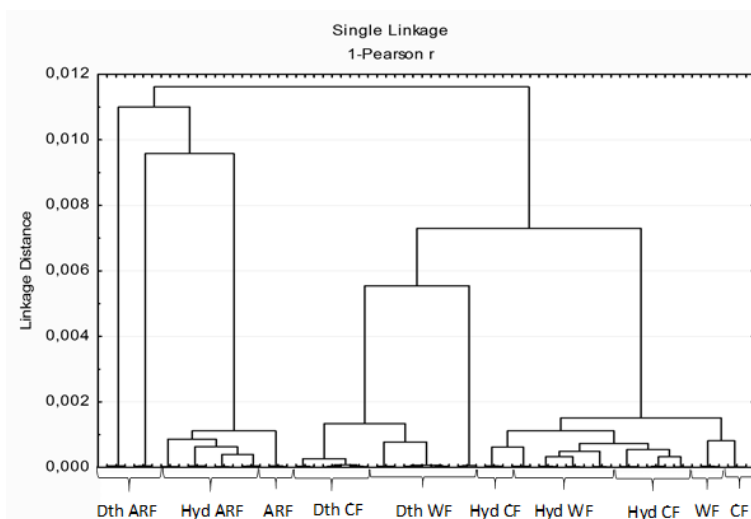

Figure 4. Dendrogram of the fractions based on D2OD 8/0 nm spectra in the case of all treatments (Dth = dry-thermal treated, Hyd = hydrothermal-treated, CF = cake flour, WF = wheat flour, ARF = aleurone-rich wheat flour).

On the CA dendrogram (Fig. 4.) all fractions were separated clearly, first of all the ARF fraction. Between the CF and the WF fraction could be observed the separation according to the treatments primarily, not according to the type of fractions owing to its chemical similarity. But the other side in the case of the CF and WF fractions the CA method is able to detect the differences between this two fractions, within the dry-thermal treated and hydrothermal-treated samples, respectively.

CONCLUSIONS

The differences between the effects of heat treatments were detectable using NIR spectra. The score plots of principal component analysis (PCA) and the dendrogram of cluster analysis (CA) were able to observe deviation according to the milling fractions and based on the different types of treatments too. The quality changes of the fractions and the correlations of the main chemical components could be evaluated according to the spectra. So close correlation were obtained between the processed data of spectroscopic measurement techniques and the types of heat treatments. Hereby information were getting about the stability and the quality changes according to the effects of the

treatments in the milling fractions.

ACKNOWLEDGEMENTS

The authors gratefully acknowledge Sándor Tömösközi and Blanka Bucsella (Budapest University of Technology and Economics) for their help and Bühler AG, Switzerland to provide the treated samples. This work is connected to the scientific program of the "Development of quality-oriented and harmonized R+D+I strategy and functional model at BME" project. This project is supported by the New Hungary Development Plan (Project ID: TÁMOP-4.2.1/B-09/1/KMR-2010-0002). And this work is connected to the national project of the "Development of breeding, agricultural production and food industrial processing system of Pannon wheat varieties" (Tech_09-A3-2009-0221).

REFERENCES

- Bagdi, A., Szabó, F., Gere, A., Kókai, Z., Sipos, L., Tömösközi, S. (2014): Effect of aleurone-rich flour on composition, cooking, textural, and sensory properties of pasta, *LWT-Food Sci. Technol.* 59, 996-1002. DOI: 10.1016/j.lwt.2014.07.001
- Bucsella, B., Takács, Á., Vizer, V., Schwendener, U., Tömösközi, S. (2016): Comparison of the effects of different heat treatment processes on rheological properties of cake and bread wheat flours, *Food Chem.*, 190, 990-996. DOI: 10.1016/j.foodchem.2015.06.073.
- Centre for Agricultural Research – Hungarian Academy of Sciences, (2011): Cereal Varieties from Martonvásár. In: Staff of the Cereal Breeding Department, Cereal Resistance Breeding Department, Crop Production Department, Prebázis Ltd., Elitmag Ltd. (ed.), Martonvásár, Hungary: Agricultural Institute, Martonvásár, Centre for Agricultural Research, Hungarian Academy of Sciences (Published), pp. 2-3.
- Chang, O. K. (2003): Improving wheat quality. In: *Bread Making: Improving quality*, Stanley, P. C. (ed.), Cambridge, England: Woodhead Publishing Ltd., p. 540.
- Chiu, C. W., Schiermeyer, E., Thomas, D. J., Shah, M. B., Hanchett, D. J., Jeffcoat, R. (1999): U.S. Patent, 32(5), 009–017.
- Chung, H.-J., Min, D., Kim, J.-Y., Lim, S.-T. (2007): Effect of minor addition of xanthan cross-linking of rice starches by dry heating with phosphate salts, *J. Appl. Polym. Sc.*, 105, 2280–2286. DOI: 10.1002/app.26237
- Evans, A. J., Huang, S., Osborne, B. G., Kotwal Z., Wesley I. J. (1999): Near infrared on-line measurement of degree of cook in extrusion processing of wheat flour, *JNIRS* 7, 77-84. DOI 10.1255/jnirs.237
- Friedman, M. (1996): Food Browning and Its Prevention: An Overview, *J. Agr. Food Chem.*, 44 (3), 631-653. DOI: 10.1021/jf950394r
- Heise, H. M., Winzen, R. (2002): Fundamental Chemometrics Methods. In: *Near-Infrared Spectroscopy – Principles, Instruments, Applications*, Siesler, H. W., Ozaki, Y., Kawata, S., Heise, H. M. (ed.), Weinheim, Germany: WILEY-VCH Verlag GmbH, pp. 125-163.
- Lásztity, R. (1999): *Cereal Chemistry*, Budapest, Hungary: Akadémiai Publisher, p. 20.
- Lehtinen, P., Kiliäinen, K., Lehtomäki, I., Laakso, S. (2003): Effect of heat treatment on lipid stability in processed oats, *J. Cereal Sci.*, 37 (2), 215–221. <http://dx.doi.org/10.1006/jcrs.2002.0496>

Martens, H., Næs, T. (1991): *Multivariate calibration*, Hoboken, USA: John Wiley & Sons Ltd, pp. 97-100.

Miralbés, C. (2003): Prediction Chemical Composition and Alveograph Parameters on Wheat by Near-Infrared Transmittance Spectroscopy, *J. Agric. Food Chem.* 51, 6335-6339. DOI 10.1021/jf034235g

Pojić, M., Mastilović J., Majcen, N. (2012): The Application of Near Infrared Spectroscopy in Wheat Quality Control. In: *Infrared Spectroscopy–Life and Biomedical Sciences*, Theophanides, T. (ed.), Rijeka, Croatia: Intech Publisher, pp. 167-184.

Vigni, M., Durante, L.C., Foca, G., Marchetti, A., Ulrici, A., Cocchi, M. (2009): Near Infrared Spectroscopy and multivariate analysis methods for monitoring flour performance in an industrial bread-making process, *Anal. Chim. Acta*, 642, 69-76. <http://dx.doi.org/10.1016/j.aca.2009.01.046>

Wold, S., Esbensen K., Geladi, P. (1987): Principal component analysis, *Chemometr. Intell. Lab.*, 2, 37-52. [http://dx.doi.org/10.1016/0169-7439\(87\)80084-9](http://dx.doi.org/10.1016/0169-7439(87)80084-9)

DETERMINATION OF GLUTENIN AND GLIADIN LOCI IN CROATIAN WINTER WHEAT GERMLASM

UDC 664.236 : 633.11(497.5)

Sonja Marić¹, Marija Grgić¹, Sonja Petrović¹, Ivica Strelec², Sunčica Guberac¹, Vlado Guberac¹

*¹Josip Juraj Strossmayer University of Osijek, Faculty of Agriculture,
Kralja P. Svačića 1d, HR-31000 Osijek, Croatia*

**Corresponding author: smaric@pfos.hr*

*²Josip Juraj Strossmayer University of Osijek, Faculty of Food Technology,
Franje Kuhača 20, HR-31000 Osijek, Croatia*

ABSTRACT

Aim of the study was to examine and determine distribution of glutenin (Glu-A1, Glu-B1 and Glu-D1) and gliadin (Gli-B1 and Gli-D1) loci in twenty Croatian winter wheat varieties using SDS PAGE. Highest frequency at Glu-A1 loci was recorded for subunit 2* (50 %). At Glu-B1 loci subunit 7+9 was dominant with frequency of 45 % while the subunit 7+8 was at second place with 40 %. At these loci lowest frequency (5%) had subunit 14+15. Subunit 5+10 prevailed at Glu-D1 with frequency of 70 %. At Gli-B1 loci we determined prevalence of subunits 63+67 combination with a frequency of 50 %, while the lowest prevalence had subunit 61 with a frequency of 5 %. Subunits 60, 66 and null allele (N) were also present. At Gli-D1 locus, the most common subunit was 55 with a frequency of 90 %, combination of subunits 55 + 56 + 59 and the subunit 59 were also present with frequency of 5 %.

Keywords: winter wheat, germplasm, glutenin loci, gliadin loci

INTRODUCTION

Rapid increase of human population has led to the increased demand for producing high yielding crops able to face those demands. Since wheat is primarily a nutrition crop, creating a stabile, high-yielding and high-quality wheat is a main goal of wheat breeders. Wheat quality, particularly its protein content, is related to the protein composition of the grain since the most important proteins are found in the grain endosperm. It is well known that flour quality depends on the composition and quantity of wheat protein gluten. This protein consists of two major fractions, gliadins and glutenins, which account for about 80% of total grain proteins (Xu *et al.*, 2007). Composition of these reserve proteins has a great influence on flour and bread quality and is also associated with other important traits of wheat (Dimitrijević and Petrović, 2008).

Gliadins are mostly monomeric proteins with a molecular weight of 28 000 – 55 000 kDa, soluble in 70-90 % ethanol (Wieser, 2007). Based on their mobility in gel electrophoresis we differentiate α , β , γ and ω gliadins. Gliadins γ - and ω - are mostly encoded at Gli-1 loci (Gli-A1, Gli-B1 and Gli-D1), located on the short ends of homologous group of chromosomes 1, while α -, β - and some γ - gliadins are encoded at Gli-2 loci (Gli-A2, Gli-B2 and Gli-D2), located on the short ends of homologous group of chromosomes 6 (Salavati *et al.*, 2008a). Combination of different alleles at these loci provides a great genetic diversity among varieties. There are also some smaller gliadins loci, Gli-3, Gli-5 and Gli-6 that are controlled with a few smaller gliadins blocks and can be used to differ two identical genotypes (Metakovsky and Branlard, 1998). Gliadin alleles at Gli-1 loci can serve as a genetic markers for noodle quality because they are closely linked to Glu-3 alleles (Zhang *et al.*, 2002).

Glutenins are divided into two groups: high molecular weight glutenins (HMW) and low molecular weight glutenins (LMW). Glutenins are larger molecules consisting of disulfide-bonded subunits (Dimitrijević and Petrović, 2008). HMW subunits are encoded with genes located on the long arm of 1A, 1B and 1D chromosomes at Glu-A1, Glu-B1 and Glu-D1 loci. LMW subunits are encoded with genes located on the short arm of group 1 chromosome at the Glu-A3, Glu-B3 and Glu-D3 loci (Zhang *et al.*, 2002). All varieties of hexaploid bread wheat have six HMW subunits, two at each chromosome (1A, 1B and 1D); one high molecular weight subunit type x and one low molecular weight type y (Shewry *et al.*, 2001). Number and composition of HMW glutenin subunits has a great influence on bread making quality, dough strength and elasticity (Horvat *et al.*, 2006). According to Zhang *et al.* (2002) alleles Glu-A1b (Ax2*) and Glu-D1d (Dx5 + Dy10) are responsible for premium dough quality. HMW glutenin subunits account for approximately 10% of gluten, while LMW account for approximately 20 % of it (Wieser, 2007).

Aim of this study was to examine and determine distribution of glutenin (Glu-A1, Glu-B1 and Glu-D1) and gliadin (Gli-B1 and Gli-D1) loci in twenty Croatian winter wheat varieties using SDS PAGE.

MATERIALS AND METHODS

The study included 20 Croatian varieties of hexaploid bread wheat (*Triticum aestivum* L. spp. *vulgare*). Varieties were selected based on the year of release, importance in agricultural production and growing area (Table 1).

Distribution of ω -gliadin subunits at Gli-B1 and Gli-D1 loci, as well as the distribution of HMW glutenin subunits at Glu-A1, Glu-B1 and Glu-D1 loci, was analysed using polyacrylamide gel electrophoresis in the presence of sodium dodecyl sulfate (SDS-PAGE, Sodium Dodecyl Sulphate PolyAcrylamide Gel Electrophoresis) according to the BSA guide for wheat electrophoresis (Bundessortenamt, 2007). Vertical electrophoresis system Amersham Biosciences, SE 600 Ruby® was used, with gel dimensions 18 x 16 cm. Analysis

were conducted in Laboratory for plant genetics and biotechnology at Faculty of Agriculture and in Laboratory for biochemistry at Faculty of food technology in Osijek.

Table 1. Year of release, origin and pedigree of analysed wheat varieties

Nr.	Variety	Year	Origin	Pedigree
1.	U1	1936.	PIO	Carlotta Strampeli/Marquis
2.	Sirban Prolifik	1905.	Bohutinsky	-
3.	Zlatna Dolina	1971.	Bc institut	Zg 414-57/Leonardo
4.	Perla	1997.	AG	-
5.	BC Patria	1994.	Bc institut	Odesskaya-51/Zg-IPK-8210/2/ GK-32-82
6.	Fiesta	1998.	AG	By 87-83/Osk.3.68/2-85
7.	Gabi	1999	AG	Srpanjka/GK 32-82
8.	Kalista	2005.	AG	Divana/Soissons
9.	Matea	2005.	AG	Soissons/Perla
10.	AFZG Karla	2010.	AGRZG	SVK/VID/OBR
11.	Sana	1983.	AGRZG	Mura/C1 14123/Bc-2413/72
12.	Mihelca	1996.	Bc institut	ZG 1325/78/SO-1065
13.	Aura	1997.	Bc institut	434 K-4CM/7903-93-1
14.	Cerera	1993.	Jošt	NE-7060-76-Y-342/VG-19
15.	Divana	1995.	Jošt	Favorit/5/Cirpiz/4/J.Kwang/2/Atlas66/Co mac./3/Velvet
16.	Žitarka	1985.	PIO	Osk. 6.30-20/Slavonka/3/Eph. M68/Osk.154 -19/ Kavkaz
17.	Srpanjka	1989.	PIO	Osk. 4.50-1-77/Zg 2696
18.	Golubica	1998.	PIO	Slavonija/Gemini
19.	Aida	2006.	PIO	Srpanjka/Rialto
20.	Ilirija	2008.	PIO	Osk.-14-294-16-95/Soissons

RESULTS AND DISCUSSION

Analysis of composition and distribution of subunits at ω – gliadin loci (Table 2) *Gli*-B1 has showed that combination of subunits 63+67 was the most frequent (50 %), present in 10 wheat varieties. The second was subunit 66, with frequency of 20 %, present in four wheat varieties (Kalista, Mihelca, Aura and Ilirija). Null allele (N) had frequency of 15% and was present in three wheat varieties (Sirban Prolifik, Fiesta and Aida). Subunit 60 was determined in two wheat varieties (Cerera and Divana), with frequency of 10 %. Subunit 61 was present in one wheat variety (AFZG Karla), with frequency of 5 %. Highest frequency at *Gli*-D1 loci had subunit 55 (90 %), present in 18 wheat varieties. Subunit 55+56+59 was determined in wheat variety Mihelca with frequency of 5 %. Subunit 59 was also present in one wheat variety (Aura), with frequency of 5 % (Fig. 1).

Table 2. Distribution of ω -gliadin subunits in analysed wheat varieties

Nr.	Variety	<i>Gli</i> -B1	<i>Gli</i> -D1
1.	U1	63+67	55
2.	Sirban Prolifik	N	55
3.	Zlatna Dolina	63+67	55
4.	Perla	63+67	55
5.	BC Patria	63+67	55
6.	Fiesta	N	55
7.	Gabi	63+67	55
8.	Kalista	66	55
9.	Matea	63+67	55
10.	AFZG Karla	61	55
11.	Sana	63+67	55
12.	Mihelca	66	55+56+59
13.	Aura	66	59
14.	Cerera	60	55
15.	Divana	60	55
16.	Žitarka	63+67	55
17.	Srpanjka	63+67	55
18.	Golubica	63+67	55
19.	Aida	N	55
20.	Ilirija	66	55

Rukavina *et al.* (2012a) analysed ω – gliadin loci in 50 Croatian wheat varieties and got similar results. They determined that combination of subunits 63+67 is the most frequent one (64 %) at Gli-B1 loci, and subunit 55 is the most frequent (94 %) at Gli-D1 loci. They also claim that in the future it will be necessary to establish a connection between gliadin loci and biological traits since gliadins have an important role as a genetic markers of wheat.

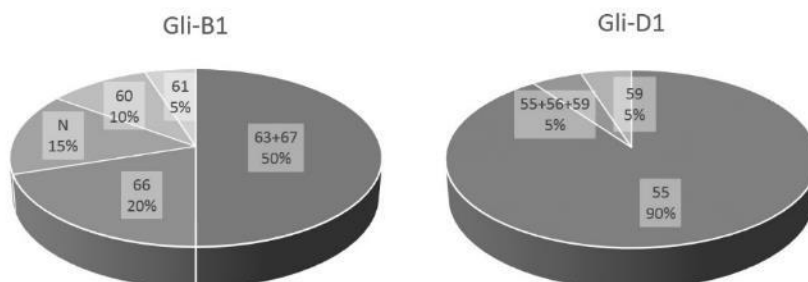

Figure 1. Frequency of ω -gliadin subunits in analysed wheat varieties

Analysis of Croatian wheat varieties obtained bigger polymorphism at Gli-B1 loci compared to Gli-D1 loci. According to Ruiz *et al.* (2002), gliadin polymorphism is very important because gliadins serve as a genetic markers for genotype identification. Different varieties origins, recombinations and gene mutations can be the reason of high gliadin loci polymorphism (Đukić *et al.*, 2005). Salavati *et al.* (2008b) were comparing genetic polymorphism in Iranian wheat varieties and concluded that Gli-2 loci show higher genetic variability compared to Gli-1 loci. Ruiz *et al.* (2002) came to the same conclusion when investigating Spanish wheat varieties. Different results were obtained by Zaefizadeh *et al.* (2010.) who investigated gliadins and genetic variability of Iranian and Azerbaijan durum wheat varieties. They found a smaller polymorphism of α - and β -gliadins, controlled by Gli-2 loci, compared to γ - and ω - gliadins, controlled mostly by Gli-1 loci. Tanaka *et al.* (2003) confirmed the same with their results.

Analysis of composition and distribution of HMW glutenin subunits (Table 3) showed that the most frequent subunit at Glu-A1 loci was subunit 2* with frequency of 50 %, present in 10 wheat varieties. Subunit 1 had a frequency of 25%, and was present in five wheat varieties (Sirban Prolifik, BC Patria, Gabi, Srpanjka and Aida). Null allele was also found in five wheat varieties (Perla, Fiesta, Sana, Žitarka and Golubica) with frequency of 25%. At Glu-B1 loci combination of subunits 7+9 had the highest frequency (45 %), and at the second place was combination of subunits 7+8 with frequency of 40 %. Combination of subunits 6+8 was present in two wheat varieties (Zlatna Dolina and Sana), with frequency of 10 %. The lowest frequency at this loci had combination of subunits 14+15

(5 %), present in one wheat variety (U1). At Glu-D1 loci the most prevalent combination of subunits was 5+10, present in 14 wheat varieties, with frequency of 70 %. Combination of subunits 2+12 was present in six wheat varieties, with frequency of 30 % (Fig. 2). Similiar results were obtained by Rukavina *et al.* (2012b) who investigated 50 Croatian varieties of hexaploid winter wheat. They determined that the most frequent subunit at Glu-A1 loci was subunit 2* (56 %), at Glu-B1 loci subunit 7+8 (40%) and at Glu-D1 loci subunit 5+10 (68 %). The average number of alleles per locus was 4.33.

Table 3. Distribution of HMW glutenin subunits in analysed wheat varieties

Nr.	Variety	Glu-A1	Glu-B1	Glu-D1
1.	U1	2*	14+15	2+12
2.	Sirban Prolifik	1	7+9	2+12
3.	Zlatna Dolina	2*	6+8	2+12
4.	Perla	N	7+8	5+10
5.	BC Patria	1	7+9	5+10
6.	Fiesta	N	7+9	5+10
7.	Gabi	1	7+9	5+10
8.	Kalista	2*	7+8	5+10
9.	Matea	2*	7+8	5+10
10.	AFZG Karla	2*	7+8	5+10
11.	Sana	N	6+8	2+12
12.	Mihelca	2*	7+9	5+10
13.	Aura	2*	7+8	5+10
14.	Cerera	2*	7+9	5+10
15.	Divana	2*	7+9	5+10
16.	Žitarka	N	7+8	2+12
17.	Srpanjka	1	7+9	5+10
18.	Golubica	N	7+9	2+12
19.	Aida	1	7+8	5+10
20.	Ilirija	2*	7+8	5+10

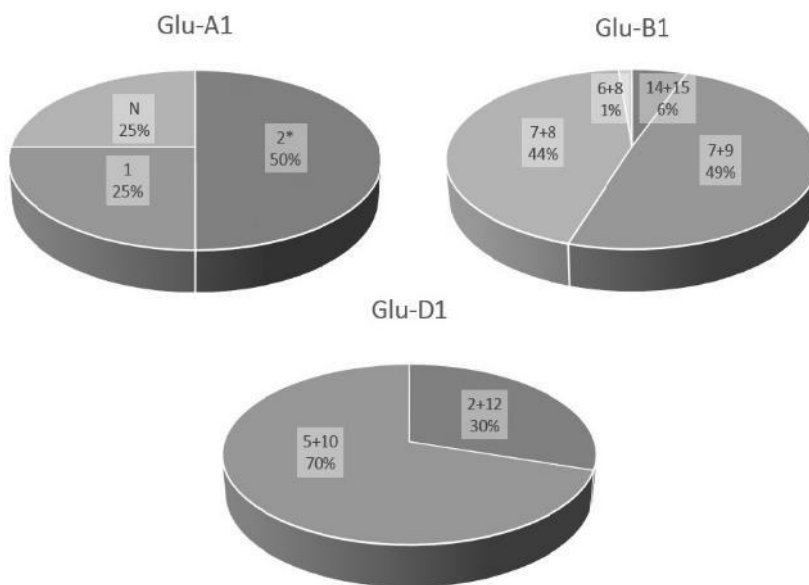

Figure 2. Frequency of HMW glutenin subunits in analysed wheat varieties

Dimitrijević and Petrović (2008) investigated genetic variability of Glu-A1, Glu-B1 and Glu-D1 loci of hexaploid wheat. They concluded that allelic variability at Glu-A1 has an influence on rheological properties of wheat, where subunit 2* had the most optimal effect. Allelic variability at Glu-B1 loci had the smallest influence on quality. The biggest influence on phenotypic variability had allelic variability at Glu-D1 loci. Same authors claim that some subunit combinations can serve as an orientation phenotypic marker for selection of superior genotypes in early generations of breeding process. According to Horvat *et al.* (2009) different combinations of HMW-GS alleles have a different influence on bread making quality. Subunits 1 and 2* at Glu-A1, 7+9 and 17+18 at Glu-B1 and 5+10 at Glu-D1 loci are related with higher dough strength and bread volume, while null allele at Glu-A1, subunit combination 6+8 at Glu-B1 and subunit combination 2+12 at Glu-D1 loci are connected with negative effects on bread making quality. The high frequency of 2*, 7+9 and 5+10 subunits at gliadin loci of analysed wheat varieties is probably result of breeding for bread making quality in wheat.

CONCLUSIONS

The analysis of 20 Croatian wheat varieties on composition of ω – gliadin loci determined that at Gli-B1 loci the most frequent subunit combination was 63+67 (50 %) and at Gli-D1

loci subunit 55 (90 %). Also, bigger polymorphism was obtained at Gli-B1 loci compared to Gli-D1 loci. Analysis of HMW glutenin loci determined that at Glu-A1 loci the most frequent subunit was 2* (50%), at Glu-B1 loci subunit combination 7+9 (49 %) and at Glu-D1 loci subunit combination 5+10 (90 %). The high frequency of this subunits is probably result of breeding for bread making quality in wheat, since these subunits are connected with premium quality of wheat. Genetic variability of glutenin and gliadin loci is very important for future breeding programs and selection of wheat varieties for special purposes. Also, these loci have an important role and potential as genetic markers of wheat.

REFERENCES

- Bundessortenamt (2007): Guidelines for the conduct of electrophoresis tests for distinctness, uniformity and stability of wheat.
- Dimitrijević M., Petrović S. (2008): Effect of HMW glutenin allelic variation on wheat. In: 43rd Croatian and 3rd International Symposium on Agriculture, February 18 – 21, Opatija, Croatia, pp. 286-289.
- Đukić N., Matić G., Konjević R. (2005): Biochemical analysis of gliadins of wheat *Triticum durum*, *Kragujevac Journal of Science*, 27, 131-138.
- Horvat D., Drezner G., Šimić G., Dvojković K. (2006): Determination of wheat storage proteins by RP-HPLC method, *Agriculture*, 12 (2), 42-47.
- Horvat, D., Kurtanjek, Ž., Drezner, G., Šimić, G., Magdić, D. (2009): Effect of HMW glutenin subunits on wheat quality attributes, *Food Technol. Biotechnol.* 47(3), 253-259.
- Metakovsky E. V., Branlard G. (1998): Genetic diversity of French wheat germplasm based on gliadin alleles, *Theoretical and Applied Genetics*, 96, 209-218. doi: 10.1007/s001220050729.
- Ruiz M., Rodriguez-Quijano M., Metakovsky E. V., Vazquez J. F., Carillo J. M. (2002): Polymorphism, variation and genetic identity of Spanish common wheat germplasm based on gliadin alleles, *Field Crops Research*, 79, 185-196. doi:10.1016/S0378-4290(02)00139-9.
- Rukavina I., Marić S., Guberac V., Petrović S., Čupić T., Tepper C. (2012a): Gliadin loci composition analysis of croatian hexaploid wheat germplasm, *Seed Science Journal*, 29 (3-4), 91-100.
- Rukavina I., Marić S., Guberac V., Petrović S., Čupić T., Tepper C. (2012b): Glutenin loci variability of croatian wheat germplasm, *Agriculture*, 18(2), 30-35.
- Salavati A., Boushehri A. A. S. N., Hassani M. E., Yazdi – Samadi B. (2008a): Evaluation of Iranian bread wheats by storage proteins „gliadins“. In: 11th International Wheat Genetics Symposium, 24 – 29 August 2008, Brisbane, QLD, Australia, pp 283-288.
- Salavati A., Sameri H., Boushehri A. A. S. N., Yazdi-Samadi B. (2008b): Evaluation of Genetic Diversity in Iranian Landrace Wheat *Triticum aestivum* L. by Using Gliadin Alleles, *Asian Journal of Plant Sciences*, 7 (5), 440-446.
- Shewry P. R., Popineau Y., Lafiandra D., Belton P. (2001): Wheat glutenin subunits and dough elasticity: findings of the Eurowheat project, *Trends in Food Science & Technology*, 11(12), 433-441. doi:10.1016/S0924-2244(01)00035-8.

Tanaka H., Tomita M., Tsujimoto H., Yasumuro Y. (2003.): Limited but specific variations of seed storage proteins in Japanese common wheat (*Triticum aestivum* L.), *Euphytica*, 132, 167-174. doi: 10.1023/A:1024638616507.

Wieser H. (2007): Chemistry of gluten proteins, *Food Microbiology*, 24 (2), 115-119. doi:10.1016/j.fm.2006.07.004.

Xu J., Bietz A. J., Carriere C. J. (2007): Viscoelastic properties of wheat gliadin and glutenin suspensions. *Food Chemistry*, 101(3): 1025-1030. doi:10.1016/j.foodchem.2006.02.057.

Zaefizadeh M., Jamaati-e-Somarin S., Ojaghi J., Seyedi S. M., Zabihi-e-Mahmoodabad R., Ochi M. (2010): Genetic diversity for gliadin patterns of durum wheat landraces in the Northwest of Iran and Azerbaijan. *Pesquisa Agropecuária Brasileira*, Brasília, 45(11): 1425-1432. <http://dx.doi.org/10.1590/S0100-204X2010001200013>.

Zhang W., Gianibelli M. C., Ma W., Rampling L., Gale K. R. (2002): Identification of SNPs and development of allele-specific PCR markers for γ -gliadin alleles in *Triticum aestivum*. *Theoretical and Applied Genetics*, 107(1): 130-138. doi: 10.1007/s00122-003-1223-2.

A COMPARATIVE ANALYSIS OF TRADITIONAL AND E-MARKETING POTENTIALS IN THE BAKING INDUSTRY

UDC 664.61 : 339.138

Branimir Dukić^{1}, Ivan Ružičić², Stojanka Dukić³*

¹*Faculty of Economics in Osijek; Gajev trg 7, HR-31000 Osijek, Croatia*

^{*}*Corresponding author: bdukic@efos.hr*

²*Belje d.d. Darda, Darda, Industrijska zona 1, Mece, Croatia*

³*duxMission d.o.o. Osijek, Dalmatinska 21, HR-31000 Osijek, Croatia*

ABSTRACT

In modern times it is almost impossible to find a product that does not have very strong competition, and whose sales are not closely related to successful marketing. In the past, when the market was characterized by shortage of goods, the dominant concept was the one in which the manufacturer produced relying on his own judgement, i.e. the production concept. As the number of producers grew, there was a quantitative and qualitative leap resulting in stronger competition. How to sell your products soon became the key issue facing all producers. The initial attempts to push a product in the market, characteristic of the production concept, could not achieve long-term success. A buyer can be persuaded to buy a certain product once or twice, however, the consumer learns and will lose interest in a product that does not satisfy his/her needs. Therefore, it is no wonder that the new, marketing concept appeared as a solution for this problem. The basic idea of the marketing concept is to examine consumer needs, and to devise products that can satisfy those needs. In this way, the consumer will decide to buy such products of his/her own, without any 'coercion'. The physical world allows for occasional research of consumer needs, whereas the virtual world comprised of the Internet, i.e. the Web environment, allows for permanent investigation into consumer needs, which is the basis of the electronic, that is, e-Marketing. This research focuses on the comparative analysis of potentials of the traditional and e-Marketing in the baking industry.

Keywords: marketing, e-Marketing, baking industry, internet, Web, consumers, market research

INTRODUCTION

One of the key issues of applying marketing in industry in general, and thus in the baking industry as well, is the approach to the production process organisation and realization. What is left of the industry in Croatia still has the mindset of the times past, when scarcity was the rule and markets were hungry for all kinds of goods. Decisions on production are

frequently made intuitively, based on personal preferences and wishes of the management, rather than based on the needs of population. To make matters worse, this is the usual method of large baking manufacturers and smaller baking businesses alike. In several studies conducted by the present authors on their own or in collaboration with other authors, covering the Republic of Croatia in the period 2010-2013, it was shown that management, especially in the older age group, often misinterpret the term marketing, as they view it as the advertising industry.

It is no wonder then that marketing is frequently seen as something negative, something that drains financial resources, while its results are either not clearly measurable or its impact is negligible. Marketing professionals are usually put in a separate organisational unit, and not allowed to “meddle” in business operations, especially the production process. Such a technocratic approach shows that marketing is accepted in a wrong way, but it also shows lack of understanding. In essence, marketing is a contemporary managerial philosophy whose task is to examine consumer needs, define the target market, develop a product and quantities to meet those needs, determine its price and ways of distribution, and after selling it, find out about customer satisfaction. Marketing is a cyclical process, which in the past was carried out only periodically due to limited possibilities, whereas modern information and communication technology allows permanent marketing activity. Therefore, marketing is far from being limited to advertising industry. It is a modern business philosophy, and the only appropriate and reliable way of conducting business processes in highly competitive environments. On the other hand, advertising industry is a relic from the past when the production concept was predominant and its main task was to “push” a product at a buyer, regardless of whether the product suits his/her needs. Although marketing and advertising industry share the same tasks, i.e. they both aspire towards product realisation, they actually use the opposite target groups and the opposite tools. While the selling concept is focused on buyers and uses all means to persuade them to buy a product, the marketing concept is focused on consumers and uses all means to satisfy consumers' needs.

Since the 1950-ies, marketing has gone through several development phases, and today's modern information and communication technology has greatly changed the way marketing functions. Whereas in the past marketing was a mass concept and entire population was either seen as a monolithic consumer group, or roughly categorised according to various characteristics, modern marketing is oriented toward an individual with whom it wishes to establish a cooperative relationship. Such an approach would not be possible without application of modern information and communication technology. Information and communication technology itself has opened up new possibilities for the impact of marketing, resulting in the new type of marketing - electronic marketing or e-Marketing. To be able to survive in an increasingly difficult business environment, the baking industry, particularly smaller businesses, should make intensive efforts to apply both conventional marketing and modern e-Marketing. In that sense it is interesting to analyse the methods of operation of these two concepts and offer a model for application of marketing in a modern business environment.

MATERIALS AND METHODS

Like other industries in the Republic of Croatia, the modern baking industry is facing difficulties in doing business, resulting from both increased competitiveness followed by a decrease in the population's purchasing power and changed eating habits. The question nowadays is not whether marketing philosophy should be applied in the baking industry, but how it should be done. The problem of applying marketing philosophy in the baking industry has become more complex due to the development of a new virtual environment formed by modern information and communication technology. Therefore, it is necessary to consider potentials of both conventional and electronic marketing and compare their means and methods of operation. Finally, optimum methods for application of conventional and e-Marketing in the baking industry should be found. Regarding the issues related to application of marketing philosophy in the baking industry, the following initial hypotheses have been set:

- H1: Important differences between traditional marketing and e-Marketing in the baking industry can be found in the environment and the technical means used in its application.
- H2: The baking industry can successfully apply marketing and e-Marketing to survive in the circumstances of local and global transparency.

Based on the above hypotheses, the following research goals have been set:

1. to analyse conditions of doing business and changes expected in the following period in business operations of the baking industry;
2. to establish differentiation among the production, selling and marketing concepts in the baking industry;
3. to define an e-Marketing model in the baking industry.

The research was primarily conducted deductively, as the initial hypothesis that was explored by means of a mental experiment was used as a starting point. The main method utilized to accomplish the research goal is the modelling method. In order to correctly define the analogies in the process of modelling between the original and the model we will apply the systematic approach. In addition to the above methods, other scientific and research methods were used.

RESULTS AND DISCUSSION

It is obvious that information and communication technology is forming a new environment that changes principles of doing business and marketing principles. In the light of this fact, we can talk about the existence of e-Business that derives the development of e-Marketing. As information and communication technology evolves, e-Business evolves too, resulting in constant transformations of e-Marketing. However, the key issue is whether there are important differences between marketing in the physical environment and marketing in the virtual environment.

Although marketing as a business philosophy has been present for some sixty years, most of the people today, including those with formal knowledge of economics, see marketing as a promotional activity and confuse its tasks and methods of operation with the production or the selling concept. The simplest way is to consider marketing as a business philosophy that should be primarily used by management, and whose task is to satisfy consumers' needs. To achieve this, marketing focuses on consumers. Whereas the selling concept is focused on the buyer and finding the ways to persuade him/her to buy a product, the marketing concept explores consumers' needs and tends to satisfy these needs through identification of a suitable product, its price, distribution method and method of presenting the product and providing information about it. Consequently, the selling concept is aggressive in its approach, whereas the marketing concept tends to communicate with buyers and receive from them information about their needs, and provide information about the product. Therefore, marketing is essentially an information process. Figure 1 shows the development phases in business philosophy.



Figure 1. Evolutionary processes that resulted in marketing (Source: Meler, M.)

Although we live in the age of the marketing concept (according to Figure 1), a significant proportion of economic operators still behave according to the principles of the production and selling concepts. Accordingly, marketing and e-Marketing are not frequently used in business operations of the baking industry, where the production concept is predominant. Instead of being focused on consumers' needs, this concept is focused on the production process, i.e. the product, and its sale is taken for granted. However, almost every product in today's market has sharp competition and its sale closely depends on successful marketing. The same applies to the baking industry. Considering the growing levels of knowledge and awareness among the general public, changes in nutrition, increasing product transparency and increasingly sharp competition both in terms of price and quality, the baking industry requires urgent transformation from the management style based on the selling concept to the management based on the marketing concept.

Here are some important characteristics of modern marketing:

- Marketing is a business philosophy that defines a business process based on customer needs
- Marketing is an informational phenomenon:
 - o Collects information about the needs of consumers
 - o Forwards the information to consumers in order to create information superiority
- E-Marketing - marketing in electronic (virtual) environment
- Today the most important part of e-Marketing - online (real-time) marketing

Elements of the marketing model in the baking industry:

$$M_{BI} = M_{VRBI} + M_{mixBI} + M_{aBI} + M_{CBI}$$

where:

Mvr – Market research

Mmix – e-Marketing mix

Mp – e-Marketing application

Mk – e-Marketing control

Marketing application phases:

Marketing research as the first phase

Physical environment

Marketing mix optimization

Unlike physical marketing, e-Marketing uses modern information and communication technology, thus defining different elements in the marketing model. Elements of e-Marketing model in the baking industry:

$$eM_{BI} = eM_{VRBI} + eM_{mixBI} + eM_{aBI} + CRM + eM_{CBI}$$

where:

eMvr – Market research in the virtual environment

eMmix – e-Marketing mix

eMp – e-Marketing application

CRM – Customer Relationship Management

eMk – e-Marketing control

e-Marketing application phases:

Structuring of Technology - modelling optimal ICT platform

Selection of optimal e-Marketing techniques

Permanent e-Marketing research

As e-Marketing is becoming an important factor in modern business operations, especially for smaller producers in the baking industry, its success, i.e. success of producers in the modern business environment requires: Be the first - Be ahead of time. This involves permanent consideration of evolutionary processes in information and communication technology and constant adjustment to the marketing potentials of information and communication technology. Important success factors in the application of ICT for the next 5-10 years are as follows:

- Communication – bidirectional – users want to create Content (blogs, chats, video chats, social networks, location-intelligent services - ambient intelligence, ...)
- Constant creation of new multimedia contents - keeping attention
- Effect of the individual on the group (social character), and engaging the right people who have a high index of social impact - opinion makers
- Exclusivity (both - content and content creator - opinion makers)
- Information about the processes in the social environment (constantly measured indices of social presence and social impact).

Some major issues in the application of e-Marketing are as follows:

- Too wide
- Loss of exclusivity
- everyone sees everything, everyone has information about everyone else, everyone can find everyone, everyone can comment on anything or anyone,
- Constant presence (24/7) – the problem of negative trigger
- Increased communication speed,
- Problem of keeping the interests of users,
- Constant adjustments.

The technological structural model of the implementation of e-Marketing for the next 5-10 years:

$$eMp(thl) = m(\text{transf}(\min(\text{Web}_{1.0}) \rightarrow \text{Web}_{3.0}) + \max(\text{Web}_{2.0}) + \text{HR}_{vi} + W_{\text{metrix}} + \text{BI}_{su} + \text{CRM}_{2.0} + \text{SEO} + \text{GEO})$$

where:

- m – mobility
- $\text{transf}(\min(\text{Web}_{1.0}) \rightarrow \text{Web}_{3.0})$ – transformation of the Web 1.0 to Web 3.0 – minimizing the content created by owner-supplier
- $\max(\text{Web}_{2.0})$ – increased presence on social networks
- W_{metrix} - Using the services (e.g. Cloud) that measure the impact on the user community (social index or social impact, which tells how a person publishes, how many followers he/she has overall)
- HR_{vi} - using people with a high social index
- BI_{su} – use your own business intelligence tools for measuring the social index of individuals on the network and the social index of the entire organization
- SEO – Search Engine Optimization
- GEO – location-intelligent services - ambient intelligence (e.g. FourSquare)

Optimal e-Marketing techniques for the next 5-10 years (Dukić, S. 2012):

- Viral marketing – use resources opinion of leaders, or people with a high social index for stimulating chain reaction
- Affiliate marketing – use significant popular Web sites that allow placing banners of hyperlinks
- Referral marketing – combination of viral and affiliate marketing (e.g. hyperlink on a social network - “tell a friend”)
- One-to-One marketing – path of Web 2.0 concept (CRM concept) adjustment of products to consumer, as well as monitoring of consumer behaviour in pre-sale, sale and after-sale services
- Real-time marketing – “being at the right place at the right time” - just in time
- Content marketing – technique of creating and distributing relevant content to attract, acquire and activate the most important customers (the Pareto Law 80:20)

CONCLUSIONS

After the conducted research and consideration of possibilities for application of marketing and e-Marketing in the baking industry, a conclusion can be made that marketing and e-Marketing are essentially identical concepts that share the same operation principles, but they are also different from each other. Important differences between marketing and e-Marketing include the environment in which they operate, operation methods and means they use. In the first place they use different technologies. The traditional physical marketing uses physical systems to gather market- or consumer-related information and it uses physical methods to transfer information to consumers, whereas e-Marketing uses information and communication technology for the same purposes. In both cases, marketing, physical as well as electronic, can be applied as a concept in the baking industry. However, it is obvious that marketing will be first applied by small systems in the baking industry, whereas large systems will also have to accept its application as they continue to be pressured by the market, i.e. environment. Implementation of marketing, both physical and electronic, should be initiated in the baking industry today, at the times when the proportion of physical and electronic processes is generally becoming equal. The baking industry will increasingly need marketing, especially e-Marketing, because the evolution of consumers increases demands for satisfying specific consumers' needs. The consumer is becoming a strong individual who wishes a product "tailored to his or her needs". Owing to this position and aspiration of consumers, it will be possible to successfully apply both the marketing concept and e-marketing concept in the baking industry as in any other branch.

REFERENCES

- Dukić, S. 2012. e-Marketing humanitarnih i vjerskih organizacija, PhD Thesis, Faculty of Economics in Osijek. Osijek
- Dyche, J. 2002. The CRM Handbook – A Business Guide to Customer Relationship Management. Addison-Wesley Information Technology Series. Boston.
- http://brel54.blogspot.com/2010_11_01_archive.html; Accessed on: 15 September 2011
- Kotler, Ph. 2001. Upravljanje marketingom, Analiza, Planiranje, Primjena i Kontrola. Mate Zagreb. Zagreb.
- Meler, M. 1999. Marketing, Faculty of Economics in Osijek. Osijek.
- Meler, M., Dukić, B. 2007. Upravljanje odnosima – od potrošača do klijenta (CRM). Faculty of Economics in Osijek. Osijek.

THE GOLDEN PATH OF BRANDING FLOUR AND BAKERY PRODUCTS FROM CROATIAN FIELDS

UDC 664.66 : 339.138(497.5)

Marija Vukobratović¹, Dubravka Živoder¹, Josipa Pavičić^{1}, Petra Tudor¹,
Nada Barišić²*

¹Croatian Agricultural Agency, Poljana Križevačka185, HR-48260 Križevci, Croatia,
(office in Zagreb: Ilica 101, HR-10000 Zagreb, Croatia);

*Corresponding author: jpavicic@hpa.hr

²Žitozajednica d.o.o., Štefanovečki zavoj 110, HR-10000 Zagreb, Croatia

ABSTRACT

Flour is the main ingredient of bread that produced by mixing flour with water, milk, whey, or some other fluid with the addition of salt or sugar, fat, eggs and yeast. In the last few years, production of flour, bread and bakery products is increasing but parallel with that, import of these products in Republic of Croatia is also growing.

Croatian Agricultural Agency recognized the position of domestic producers, so the agency decided to brand flour, bread and bakery products with proven traceability under their own brands produced from domestic raw materials in a way that domestic raw material are in the value chain. The main goal of this is to create value-added products at each stage of production as strengthening market positions of all subjects involved in the value chain as well as the conservation of domestic production.

By creating a new brand on all levels of the production chain (*Flour from Croatian fields – Bread from Croatian fields*) it is trying to influence on improvement of external trade balance in the agricultural, milling and bakery sector and to the impact on gross domestic product (GDP) growth.

Keywords: flour, bread, value-added product

INTRODUCTION

Flour is a product of repeated mechanical grinding and sieving of grain cereals, legumes, tubers, oil seeds, other food ingredients and spices. From nutritional standpoint, flour is a semiproduct which serves as the main raw material for the production of bread, bakery products, biscuits, pasta and desserts or as a supplement in food preparation.

On the market, flour appears under different names, which shows its origin, manufacturing process or purpose.

There are various types of flour:

- wheat meal,
- meal for cakes,
- multipurpose meal,
- integral meal,
- graham meal (whole grain),
- instant meal (thermally or enzymatically treated),
- corn meal, etc.

Bread as food is used for at least 10 000 years, and at the beginning it was made only from water and wild grains. Although through history the rule was “only people of lower social status eat dark bread”, today dark types of bread is consumed by those who take care of their nutrition. Bread is a product produced by mixing flour with water, milk, whey, or some other fluid with the addition of salt, sugar, fat, eggs and yeast.

The nutritional value of bread is determined by its components, while the basic differences between the individual types of bread refers to the type of flour from which the bread is made of. Bread can be made from different types of grains, such as wheat, rye, barley, oats, corn, millet, buckwheat, sorghum millet and emmer wheat

Table 1. The chemical composition of black and white bread

ELEMENTS	DARK BREAD	WHITE BREAD
Raw protein	13.6	9.6
Raw fibers	2.9	0.5
Carbohydrates	79.6	88.2
Minerals	2.4	0.4
Phosphorus	0.9	/
Iron	0.04	/
Calcium	0.2	0.1
Magnesium	0.2	/
Potassium	0.3	/

As food, bread has a great importance and in its name a various events are organized, for example: *Bread days – days of thanksgiving for the fruits of the land* that are held every year in October.

The history of bread is the history of civilization since the cultivation of cereals provided the transition from hunting and nomadic way of life to agriculture. We all know that farming as a branch of agriculture is one of the biggest, and we can also say the most important industries in the world. As in other countries, farming in Croatia as well has a very important place in the total production.

Table 2. Roughly production of bread and bakery products in Republic of Croatia

BAKERY PRODUCTS	SUBGROUPS OF BAKERY PRODUCTS	YEAR		
		2012	2013	2014
BREAD	T-550	95.400	74.000	76.375
	T-850	138.000	144.000	147.00
	T-1100,1600	6.500	7.000	7.125
	Secale meal	1.100	1.100	1.125
	Corn meal	2.700	1.900	1.875
	Miwed meal	45.600	20.000	20.250
	Customised	27.400	43.500	44.250
	Bread total:	316.00	291.500	298.000
BAGELS		27.000	32.500	33.00
OTHER TYPES		37.000	44.000	47.000
TOTAL (t)		380.000	368.000	378.000

Source: Žitozajednica, 2015.

Table 3. Industrial production of bread and bakery products in Republic of Croatia

	2010	2011	2012	2013	2014	Indeks 2014/2013
BREAD	136.436	135.189	151.456	147.426	149.986	101.7
CAKES	17.519	16.156	15.897	16.130	18.030	111.8
COOKIES	23.249	23.420	22.022	20.787	22.215	106.9
MELBA TOAST AND TOAST	346	460	388	269	107	39.8
BAKERY PRODUCTS WITHOUT SWEETENERS	10.616	11.499	12.234	12.103	14.805	122.3

Source: Žitozajednica, 2015.

Table 4. Import of bread and bakery products

IMPORT	BREAD (t)		Value (USD)	
	2013	2014	2013	2014
Bread, rolls, pastries and other bakery products	42.308	49.178	117.261.584	137.649.455
Bread containing honey, eggs, cheese and sour cream	7.776	8.479	12.398.675	14.010.882
Bread with raisins, panettone, meringues	5.207	8.103	18.690.379	30.259.230
Toast bread and similar	443	1.180	1.183.284	2.235.488
Pizza, pies and similar	4.395	5.908	10.579.420	14.524.516

Source: Žitozajednica, 2015.

Table 5. Export of bread and bakery products

EXPORT	BREAD (t)		VALUE (USD)	
	2013	2014	2013	2014
Bread, rolls, pastries and other bakery products	17.323	21.369	50.194.975	63.660.432
Bread containing honey, eggs, cheese and sour cream	6	1.060	46.418	1.553.409
Bread with raisins, panettone, meringues	211	300	1.023.218	1.530.568
Toast bread and similar	5	12	10.147	27.439
Pizza, pies and similar	632	1	2.060.662	5.121.627

Source: Žitozajednica, 2015.

At the period between 2013 and 2014, we can see that the import of bread and rolls significantly increased, so the Croatian Agricultural Agency has recognized the importance of the situation of domestic bakery production. With proven traceability of flour, bread and bakery products Croatian Agricultural Agency decided to brand flour, bread and bakery products as well as domestic product manufactured from local raw materials in a way that domestic raw material is in the value chain. The main objective of this is the creation of value-added products at each stage of production and to strengthen the market position of everyone involved in the value chain as well as the preservation of domestic production.

The goal of the project

Croatian Agricultural Agency launched projects *Bread from Croatian fields* and *Flour from Croatian fields* with the aim of labelling flour, bread and bakery products, and through promotional campaign and proven traceability of domestic production of cereal grains to provide high quality of bakery products with the established origin.

With the mentioned projects, we provide the consumers the information, awareness of origin and a high-level quality of purchased products and at the same time the protection and development of local agricultural production is preserved.

All labelled food with labels *Bread from Croatian fields* and *Flour from Croatian fields*, must conform to the legislation relating to that food.



Figure 1. Labels

The right for using the Label

The right for using the label *Bread from Croatian fields* can be approved only for bread and bakery products made from flour produced from cereal grains sown in Croatia. Entities who place bread and bakery products on the market intended for the final consumer must have signed the *Label License Agreement* with Croatian Agricultural Agency.

The right for using the label *Flour from Croatian fields* can be approved only for flour produced from grains sowed in Croatia. Entities who place flour on the market intended for the final consumer must have signed the *Label License Agreement* with Croatian Agricultural Agency.

The labels can only be used on approved products, while for promotional purposes it can be used next by the logo sign from entity. Labels *Bread from croatian fields* and *Flour from croatian fields* must be placed on the packaging of the product, or at the point of sale in the case of unpackaged bakery products. Products, which do not have a decision of approval

for carrying the labels, must be kept separate from products that carry the labels and that must be evident for the final consumer.

The path of traceability

- Producers are required to keep records of bakery production, supply and consumption of flour, keeping records consumption of flour (KEUB book), all pursuant to the legal regulations on the production of flour and bakery products

Producers of bakery products are required to record all meal entrances immediately upon receipt of flour into the facility every day to 12 hours and the quantity of produced baked goods for the previous day.

With the KEUB book the producers of bakery products are required to have a valid original documents of the entrance of flour into the facility and that document must prove the traceability of bakery products.

- The miller is required to keep records of production and trade of flour with regard to proof of traceability, and pursuant to the special conditions for putting the flour on the market
- The Label user is required to deliver a monthly documentation of his production and using the Label in accordance with the Terms of Use.

With described method above, we follow traceability and the production of bakery products of our label users, and also follow the movement of the main ingredients of these products - flour.

Our wish is, that with the labels *Bread from croatian fields* and *Flour from Croatian fields*, we directly influence on consumers decision-making purchase, who will eventually recognize this labels and buy safe, homemade pastries and bread, allowing constant quality of flour, bread and bakery products to rais.

PRESENCE OF A POTENTIALLY TOXIGENIC *ASPERGILLUS* SPECIES IN WHEAT FLOUR

UDC 633.11 : 615.9

*Dragana Plavšić¹, Gordana Dimić², Đorđe Psodorov¹, Ljubiša Šarić¹,
Anamarija Mandić¹, Ivana Čabarkapa¹, Pavle Jovanov¹*

¹*Institute of Food Technology, University of Novi Sad, Bulevar cara Lazara 1, 21000 Novi Sad, Serbia*

**Corresponding author: dragana.plavsic@fins.uns.ac*

²*Faculty of Technology, University of Novi Sad, Bulevar cara Lazara 1, 21000 Novi Sad, Serbia*

ABSTRACT

Different types of wheat flour are present in the human nutrition. For the purpose of the milling product processing, as well as for a direct human consumption, the most significant wheat species are: wheat, rye, corn, rice, buckwheat and others. The most common contaminants of grain flour and their products are molds. Water activity (a_w) of the wheat grain and flour, in most cases reach values between 0.70 and 0.86, allowing an optimal growth for a xerophile molds, including *Aspergillus* species. Some of them synthesize and excrete the secondary metabolites, mycotoxins with different level of toxicity, in a substrate.

The aim of this work was to determine of *Aspergillus* species present in buckwheat, corn and rice flour, as well as the frequency of present species and potentially toxigenic molds.

Aspergillus species are isolated from all the samples of flour. It was determinate ten *Aspergillus* species: *Aspergillus flavus*, *A. niger*, *A. versicolor*, *A. terreus*, *A. candidus*, *A. penicillioides*, *A. glaucus*, *A. wentii*, *A. fumigatus* and *A. sydovii*. The isolated *Aspergillus* species are potentially toxigenic. The most frequently isolated species of *Aspergillus* was *A. flavus* (60 %), than *A. candidus* (33.3 %) and *A. niger* (26.67 %).

Key words: flour, molds, *Aspergillus* species, *A. flavus*

INTRODUCTION

Wheat belongs to the most significant group of agriculture products which are present in a human nutrition since long time. The most frequent cereals in human nutrition are wheat, rice and corn, while the other species such as oat, barley, rye, millet and pseudocereals – buckwheat and sorghum, are present in a smaller amount. The basic technological process in cereal production is a milling. Flour is the main ingredient for further processing. Wheat products present a staple food in human nutrition. The whole grain flour is a high quality ingredient in accordance with nutritional characteristics, due

to respectable amounts of vitamins, minerals, and especially dietary fibers. On the other hand, the cereal grain is susceptible to the different types of contamination during the ripening, harvest, storing and processing period. Molds are the most frequent contaminants of wheat grains. In the appropriate moisture environment, especially after the harvest period, if grains are not properly dried, molds are capable to an intensive reproduction. By examining a microscopic structure of grain it was determined that infection occurs in grain layer cracks and in the area of the germ. The germ is actually primary subjected to contamination because the protective layer is a thinner in that area (Žeželj, 1995). Molds that appears as flour contaminants are in the most common cases from cereal grains. Therefore, molds are only partially removed during the milling process, especially if are penetrate inside the grain by the filaments they posses. Flour is an adequate environment for xerophyle molds growth, whereas could contain 15 % of moist. Xerophyle molds are present in *Aspergillus*, *Penicillium* and *Eurotium* genera. Species of *Aspergillus*, *Penicillium* and *Eurotium* genera are so called „storage“ molds developed in a reduced moisture content of the substrate. „Storage“ molds prefers a lower moisture content of the substrate (13-18 %, <0,75 a_w) (dried fruit, milk in powder, grains and bakery products) and higher temperatures, therefore are the most frequent isolated form the storage (Sinovec *et al.*, 2006). The water activity of cereal grain and flour is in the most cases value between 0.86 and 0.70, which makes an optimal growth of xerophyle and xerotolerant molds (Škrinjar *et al.*, 2000). In the last 50 years, the presence of molds in the food products has attracted a lot attention, due to ability to produce mycotoxins. Mycotoxins are secondary metabolic product of some filamentous mold species. Toxicogenic molds could produce the toxins in a certain concentration, which depends from a particular surrounding factor (temperature, relative humidity, a_w value, the quantity of nutrients) (Muntanjola-Cvetković, 1987; Samson *et al.*, 2004; Škrinjar *et al.*, 2004; Pitt & Hocking, 2009).

Aspergillus species have potential to grow in most of substrates (foodstuffs). These species grow in optimal temperature interval, from 30 to 40 °C. Minimal a_w value that is necessary for germination is from 0.77 to 0.88 (Samson *et al.*, 2004; Škrinjar & Tešanović, 2007; Pitt & Hocking, 2009). *A. flavus* were the most frequently isolated species in the soil, the plant material decaying, in peanuts and cereal grains, especially corn. This species grow in optimal temperature interval from 25 to 42 °C. Minimal a_w value for germination is from 0.78 to 0.80. *A. flavus* is the most famous producer of aflatoxins. Aflatoxins are causing acute aflatoxicosis. From thgroup of aflatoxins AB1 is the strongest carcinogen (Kocić-Tanackov, & Dimić, 2013).

MATERIAL AND METHODS

Buckwheat, corn and rice flour were examined. Five samples of each type of flour were investigated. Isolation and determination of molds present in the investigated media was conducted on two different substrates:

1. Dichloran 18 % glycerol agar (DG18) was applied for isolation of xerotolerant molds that grow on $a_w < 0.90$

2. Malt yeast extract 50 % glucose agar (MY50G) was applied for isolation of extremely xerophyle molds that grow on $a_w < 0.70$ (Samson *et al.*, 2004; Pitt and Hocking, 2009).

The incubation temperature was 25 °C on both substrates, while results were evaluated after five and seven days. Examinations were conducted in triplets.

Colonies that were assumed to belongs to *Penicillium* species were transferred on Czapek yeast extract agar (CYA). Seeded surfaces were incubated in period of 7 days on 25 °C. The criteria described by Samson *et al.* (2004), Samson and Frisvad (2004) and Pitt and Hocking (2009) were applied for species identification. Taxonomic classification was determined on the basis of macromorphological and micromorphological characteristics of growing colonies.

RESULTS AND DISCUSSION

According to the obtained results, *Aspergillus* species were isolated from all investigated flour samples. The most *Aspergillus* species were isolated from buckwheat flour (Table 1).

Table 1. *Aspergillus* species isolated from flour samples

Sample	Number of examined samples/number of contaminated samples	Species	Number of contaminated samples
Buckwheat flour	5/4	<i>A. niger</i>	1
		<i>A. penicillioides</i>	1
		<i>A. versicolor</i>	1
		<i>A. candidus</i>	1
		<i>A. flavus</i>	3
		<i>A. fumigatus</i>	1
		<i>A. sydowii</i>	1
		<i>A. flavus</i>	3
Corn flour	5/4	<i>A. glaucus</i>	2
		<i>A. niger</i>	3
		<i>A. candidus</i>	1
		<i>A. terreus</i>	1
		<i>A. wentii</i>	1
		<i>A. flavus</i>	3
Rice flour	5/5	<i>A. candidus</i>	3
		<i>A. niger</i>	1
		<i>A. wentii</i>	1
		<i>A. terreus</i>	1
		<i>A. versicolor</i>	1

Furthermore, ten different *Aspergillus* species were isolated. The most frequently isolated species of *Aspergillus* was *A. flavus* (60 %), than *A. candidus* (33.3 %) and *A. niger* (26.67%) (Figure 1 and 2).



Figure 1. Visual appearance of *Aspergillus* species colonies: A- *A. flavus*, B- *A. candidus* and C- *A. niger*

Aspergillus species are common contaminants of grain and grain mill products (Pitt & Hocking, 2009). Riba *et al.* (2008) shown that dominant types of molds from wheat flour samples belong to the *Aspergillus* genera, especially *A. flavus* (95 %), then *A. niger* and *A. versicolor*. Furthermore, in accordance with results of Alborch *et al.* (2012), the most dominant mold species in corn flour were *A. flavus* (43.33%), then *A. candidus* (33.3%) and *A. fumigatus* (33.3%).

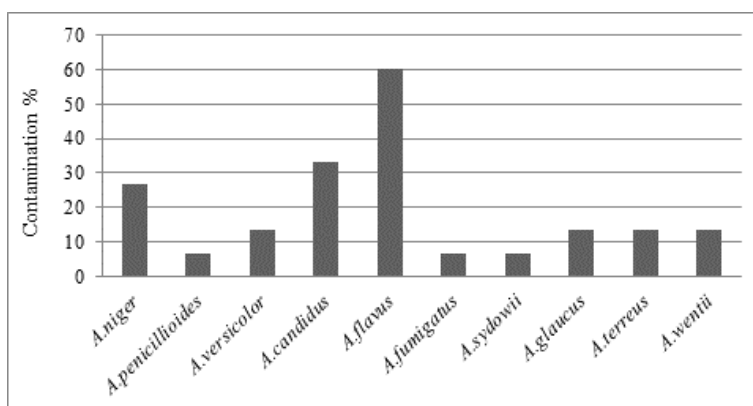

Figure 2. The frequency of *Aspergillus* species appearance in flour samples

The presence of these molds on wheat and derived products is not desirable, considering their characteristics of mycotoxicity. *A.flavus* is the most famous producer of aflatoxins, beside, other species could also synthesize a series of toxic metabolites (Kocić-Tanackov, & Dimić, 2013; Kocsube *et al*, 2013; Krnjaja *et al*, 2013). Upper mentioned molds are not the only toxigenic molds that are isolated during this research. For the most of isolated *Aspergillus* species exist a literature evidences for a possible synthesis of toxins (Samson *et al*, 2004; Škrinjar *et al*, 2004). Table 2 shows presence of isolated *Aspergillus* species and mycotoxins which can to synthesize.

Table 2. Isolated potentially toxigenic *Aspergillus* species, representation in examined samples of flour and their mycotoxins (Samson *et al.*, 2004; Pitt and Hocking, 2009; Kocić-Tanackov, 2012)

Genera	Species	Frequency of appearance (%)	Mycotoxin
<i>Aspergillus</i>	<i>A. niger</i>	26.67	Naphtho-4-pyrones, malphomins, ochratoxin A
	<i>A. versicolor</i>	13.33	sterigmatocystin, nidulotoxin
	<i>A. candidus</i>	33.33	Terphenyllin, xanthoascin
	<i>A. flavus</i>	60	Kojic acid, 3-nitropropionic acid, cyclopiasonic acid, aflatoxin B1, aspergillic acid
	<i>A. fumigatus</i>	6.67	Gliotoxin, verrucologen, fumitremorgin A&B, fumitoxins, tryptoquivalins
	<i>A. glaucus</i>	13.33	Echinulin, physcion, sterigmatocistin
	<i>A. terreus</i>	13.33	Terrein, patulin, citrinin, citreoviridin, territrem
	<i>A. wentii</i>	13.33	Emodin, ventilacton

CONCLUSIONS

Presence of *Aspergillus* species were observed in every type of flour. The total number of ten *Aspergillus* species was determined. The most *Aspergillus* species were isolated from buckwheat flour. The most dominant species was *A. flavus*, followed by *A. niger* and *A. candidus*. The most of the isolated species are potentially toxigenic. The moist content in flour were up to 15 %, which presents a beneficial environment for grow and development of xerotolerate mold species. In regards to *Aspergillus* species, the important factor for grow and development is a minimum moisture content of 14 %. It was probably one of

factors that favors a large number and frequency of *Aspergillus* species appearance in flour and related products.

ACKNOWLEDGMENTS

The results are part of research from the project no. 31029 financed by the Ministry of Science and Technology of Republic of Serbia.

REFERENCES

- Alborch, L., Bragulat, M. R., Castella, G., Abarca, M. L., Cabañes, F. J. (2012). Mycobiota and mycotoxin contamination of maize flours and popcorn kernels for human consumption commercialized in Spain. *Food Microbiology*, 32, 97-103.
- Kocić-Tanackov, Sunčica. (2012). Uticaj ekstrakata začina na rast plesni i biosintezu mikotoksina. Doktorska disertacija. Tehnološki fakultet, Univerzitet u Novom Sadu
- Kocić-Tanackov, S., and Dimić, G., (2013). Gljive i mikotoksini-kontaminanti hrane. *Hem.ind.* 67(4):639-653.
- Kocsube, S., Varga, J., Szigeti, G., Baranyi, N., Suri, K., Toth, B., Toldi, E., Bartok, T. and Mesterhazy, A. (2013). *Aspergillus* species as mycotoxin producers in agricultural products in central Europe. *Matica srpska, Journal for natural science.* 124:13-25
- Krnjaja, V., Lević, J., Stanković, S., Petrović, T. and Lukić, M. (2013). Molds and mycotoxins in freshly harvested maize. *Matica srpska, Journal for natural science.* 124:111-120.
- Muntanjola-Cvetković, M. (1990). Opšta mikologija. Naučna knjiga Beograd.
- Pitt, J. I., and Hocking, A. D. (2009). *Fungi and Food Spoilage.* Springer Science – Business Media, New York, USA
- Riba, A., Mokrane, S., Mathieu, A., Sabaou, N. (2008). Mycoflora and ochratoxin A producing strains of *Aspergillus* in Algerian wheat. *International Journal of Food Microbiology*, 122, 85-92.
- Samson, R. A., Frisvad, J., C. (2004). *Penicillium* subgenus *Penicillium*: new taxonomic schemes, mycotoxins and other extralites. Centaalbureau voor Schimmelcultures, P.O.Box 85167, 3508
- Samson, R., A., Hoekstra, E., S. and Frisvad, J., C. (2004). Introduction to food-airborne fungi. Centaalbureau voor Schimmelcultures, P.O.Box 85167, 3508 Ad Utrecht, The Netherlands.
- Sinovec, J. Z., Resanović, M. R., Sinovec, M. S. (2006). Mikotoksini: pojava, efekti i prevencija. Fakultet veterinarske medicine, Univerzitet u Beogradu.
- Škrinjar, Marija, Kolarević, I., Dimić, Gordana, and Jovanović, Olga. (2000). Occurrence of moulds and some mycotoxins in raw materials used in confectionary. *Žito hleb*, 27, 1, 9-14.
- Škrinjar, M., Vengušt, S., and Kocić-Tanackov, S. (2004). Mycotoxins in food and feed – sampling, detection, regulations. *Tehnologija mesa* 45(5–6):163–169.
- Škrinjar, Marija & Tešanović, D. (2007). Hrana u ugostiteljstvu i njeno čuvanje. Prirodno-matematički fakultet, Univerzitet u Novom Sadu.
- Žeželj, M. (1995). Tehnologija žita i brašna. Tehnološki fakultet, Univerzitet u Novom Sadu

AUTHOR INDEX

AUTHOR	PAGE	AUTHOR	PAGE
Ajredini, S.	11, 21	Gawlik-Dziki, U.	113, 132, 141
Andrejaš, M.	66	Gergely, S.	201
Avdić, A.	81	Grgić, M.	225
Avdić, G.	66, 81	Guberac, S.	225
Babić, H.	49	Guberac, V.	225
Barišić, N.	242	Hadžiomerović, E.	66
Bartalné-Berceli, M.	201, 215	Hruškar, M.	11
Bliznikas, S.	123	Hrušková, M.	1, 106
Bodroža-Solarov, M.	92	Ištvanic, T.	99
Borges, S.	49	Ivić, M.	49
Brkljača, J.	92	Izsó, E.	201, 215
Čabarkapa, I.	248	Jablonskyte-Rasce, D.	123
Čačić Kenjerić, F.	55	Jambrec, D.	73, 92
Cesnuleviciene, R.	123	Janaviciene, S.	123
Cinkmanis, I.	159, 188	Jovanov, P.	248
Colić Barić, I.	99	Jukić, M.	55
Čukelj, N.	11	Karklina, D.	159
Ćurić, D.	11, 21	Karnaš, M.	49
Czyż, J.	113	Kerienne, I.	123
Dimić, G.	248	Klava, D.	188
Domin, M.	141	Koceva Komlenić, D.	33, 55, 177
Dukić, B.	234	Kolak, P.	55
Dukić, S.	234	Kozłowicz, K.	141
Durak, A.	113	Kronberga, A.	188
Dziki, D.	113, 132, 141	Krpan, M.	11
Efendić, T.	55	Krstanović, V.	151, 168
Filipčev, B.	73, 92	Krulj, J.	92
Fonovich, T.	182	Krzysiak, Z.	141
Gagula, G.	168	Kunić, T.	99
Galoburda, R.	188	Lalić, A.	151

AUTHOR	PAGE	AUTHOR	PAGE
Lukinac, J.	33, 55	Salgó, A.	201, 215
Mandić, A.	73, 248	Sęczyk, Ł.	132
Mankevičienė, A.	123	Selmić, M.	66, 81
Marić, S.	225	Sfara, V.	182
Maričić, N.	21	Šarić, Lj.	248
Mastanjević, K.	168	Šimić, G.	151
Mastanjević, K.	151, 168	Šimurina, O.	73, 92
Miličević, D.	66, 81	Skudra, L.	159
Mujdanović, S.	66	Slačanac, V.	168
Mujkić, N.	81	Straumite, E.	188
Nedeljković, N.	73	Strelec, I.	225
Novotni, D.	11, 21	Švec, I.	1, 106
Pavičić, J.	242	Świeca, M.	113, 132
Pérez-Coll, C.	182	Szilveszter Gergely, S.	215
Pestorić, M.	73	Tudor, P.	242
Petrčić, K.	99	Vacek, K.	168
Petrović, S.	225	Vecstaudza, A.	159
Plavšić, D.	248	Velić, N.	168
Polimac, M.	33, 177	Voučko, B.	21
Psodorov, Đ.	248	Vrana Špoljarić, I.	21
Rakcejeva, T.	188	Vukobratović, M.	242
Réka, J.	201	Zagorska, J.	159
Rumbak, I.	99	Živoder, D.	242
Ružić, I.	234		
Sakač, M.	73		
Sakač, N.	49		